



**Fast Thyristor
Type TFI773-1600-28**

Low switching losses
Low reverse recovery charge
Distributed amplified gate for high di_T/dt

Mean on-state current	I_{TAV}		1600 A		
Repetitive peak off-state voltage	V_{DRM}		2000 ÷ 2800 V		
Repetitive peak reverse voltage	V_{RRM}				
Turn-off time	t_q		50.0, 63.0 μs		
V_{DRM}, V_{RRM}, V	2000	2200	2400	2600	2800
Voltage code	20	22	24	26	28
$T_j, ^\circ C$	- 60 ÷ 125				

MAXIMUM ALLOWABLE RATINGS

Symbols and parameters		Units	Values	Test conditions	
ON-STATE					
I_{TAV}	Mean on-state current	A	1600 2910	$T_c=95^\circ C$; Double side cooled; $T_c=55^\circ C$; Double side cooled; 180° half-sine wave; 50 Hz	
I_{TRMS}	RMS on-state current	A	2510	$T_c=95^\circ C$; Double side cooled; 180° half-sine wave; 50 Hz	
I_{TSM}	Surge on-state current	kA	37.0 43.0	$T_j=T_{jmax}$ $T_j=25^\circ C$	180° half-sine wave; $t_p=10$ ms; single pulse; $V_D=V_R=0$ V; Gate pulse: $I_G=I_{FGM}$; $V_G=20$ V; $t_{GP}=50$ μs ; $di_G/dt=2$ A/ μs
			39.0 45.0	$T_j=T_{jmax}$ $T_j=25^\circ C$	180° half-sine wave; $t_p=8.3$ ms; single pulse; $V_D=V_R=0$ V; Gate pulse: $I_G=I_{FGM}$; $V_G=20$ V; $t_{GP}=50$ μs ; $di_G/dt=2$ A/ μs
I^2t	Safety factor	$A^2s \cdot 10^3$	6800 9200	$T_j=T_{jmax}$ $T_j=25^\circ C$	180° half-sine wave; $t_p=10$ ms; single pulse; $V_D=V_R=0$ V; Gate pulse: $I_G=I_{FGM}$; $V_G=20$ V; $t_{GP}=50$ μs ; $di_G/dt=2$ A/ μs
			6300 8400	$T_j=T_{jmax}$ $T_j=25^\circ C$	180° half-sine wave; $t_p=8.3$ ms; single pulse; $V_D=V_R=0$ V; Gate pulse: $I_G=I_{FGM}$; $V_G=20$ V; $t_{GP}=50$ μs ; $di_G/dt=2$ A/ μs
BLOCKING					
V_{DRM}, V_{RRM}	Repetitive peak off-state and Repetitive peak reverse voltages	V	2000÷2800	$T_{jmin} < T_j < T_{jmax}$; 180° half-sine wave; 50 Hz; Gate open	
V_{DSM}, V_{RSM}	Non-repetitive peak off-state and Non-repetitive peak reverse voltages	V	2100÷2900	$T_{jmin} < T_j < T_{jmax}$; 180° half-sine wave; single pulse; Gate open	
V_D, V_R	Direct off-state and Direct reverse voltages	V	$0.6 \cdot V_{DRM}$ $0.6 \cdot V_{RRM}$	$T_j=T_{jmax}$; Gate open	

TRIGGERING				
I_{FGM}	Peak forward gate current	A	10	$T_j = T_{j\ max}$
V_{RGM}	Peak reverse gate voltage	V	5	
P_G	Gate power dissipation	W	8	$T_j = T_{j\ max}$ for DC gate current
SWITCHING				
$(di_T/dt)_{crit}$	Critical rate of rise of on-state current non-repetitive (f=1 Hz)	A/ μ s	2500	$T_j = T_{j\ max}$; $V_D = 0.67 \cdot V_{DRM}$; $I_{TM} = 2 I_{TAV}$; Gate pulse: $I_G = 2$ A; $V_G = 20$ V; $t_{GP} = 50$ μ s; $di_G/dt = 2$ A/ μ s
THERMAL				
T_{stg}	Storage temperature	$^{\circ}$ C	-60 \div 50	
T_j	Operating junction temperature	$^{\circ}$ C	-60 \div 125	
MECHANICAL				
F	Mounting force	kN	40.0 \div 50.0	
a	Acceleration	m/s ²	50	Device clamped

CHARACTERISTICS

Symbols and parameters		Units	Values	Conditions	
ON-STATE					
V_{TM}	Peak on-state voltage, max	V	2.26	$T_j = 25$ $^{\circ}$ C; $I_{TM} = 5024$ A	
$V_{T(TO)}$	On-state threshold voltage, max	V	1.40	$T_j = T_{j\ max}$;	
r_T	On-state slope resistance, max	m Ω	0.200	$0.5 \pi I_{TAV} < I_T < 1.5 \pi I_{TAV}$	
I_H	Holding current, max	mA	1000	$T_j = 25$ $^{\circ}$ C; $V_D = 12$ V; Gate open	
BLOCKING					
I_{DRM}, I_{RRM}	Repetitive peak off-state and Repetitive peak reverse currents, max	mA	300	$T_j = T_{j\ max}$; $V_D = V_{DRM}$; $V_R = V_{RRM}$	
$(dv_D/dt)_{crit}$	Critical rate of rise of off-state voltage ¹⁾ , min	V/ μ s	200, 320, 500, 1000	$T_j = T_{j\ max}$; $V_D = 0.67 \cdot V_{DRM}$; Gate open	
TRIGGERING					
V_{GT}	Gate trigger direct voltage, max	V	5.00 3.00 2.00	$T_j = T_{j\ min}$ $T_j = 25$ $^{\circ}$ C $T_j = T_{j\ max}$	$V_D = 12$ V; $I_D = 3$ A; Direct gate current
I_{GT}	Gate trigger direct current, max	mA	500 300 200	$T_j = T_{j\ min}$ $T_j = 25$ $^{\circ}$ C $T_j = T_{j\ max}$	
V_{GD}	Gate non-trigger direct voltage, min	V	0.35	$T_j = T_{j\ max}$; $V_D = 0.67 \cdot V_{DRM}$;	
I_{GD}	Gate non-trigger direct current, min	mA	15.00	Direct gate current	
SWITCHING					
t_{gd}	Delay time, max	μ s	1.06	$T_j = 25$ $^{\circ}$ C; $V_D = 1500$ V; $I_{TM} = I_{TAV}$; $di/dt = 200$ A/ μ s;	
t_{gt}	Turn-on time ²⁾	μ s	2.50, 3.20, 4.00, 6.30	Gate pulse: $I_G = 2$ A; $V_G = 20$ V; $t_{GP} = 50$ μ s; $di_G/dt = 2$ A/ μ s	
t_q	Turn-off time ³⁾ , max	μ s	50.0, 63.0	$dv_D/dt = 50$ V/ μ s;	
			63.0, 80.0	$dv_D/dt = 200$ V/ μ s;	
Q_{rr}	Total recovered charge(linear), max	μ C	1250	$T_j = T_{j\ max}$; $I_{TM} = 2000$ A;	
t_{rr}	Reverse recovery time, max	μ s	9.0	$di_R/dt = -50$ A/ μ s;	
I_{rrM}	Peak reverse recovery current, max	A	280	$V_R = 100$ V	

THERMAL					
R_{thjc}	Thermal resistance, junction to case, max	°C/W	0.0085	Direct current	Double side cooled
R_{thjc-A}			0.0187		Anode side cooled
R_{thjc-K}			0.0153		Cathode side cooled
R_{thck}	Thermal resistance, case to heatsink, max	°C/W	0.0020	Direct current	
MECHANICAL					
w	Weight, typ	g	1170		
D_s	Surface creepage distance	mm (inch)	36.60 (1.441)		
D_a	Air strike distance	mm (inch)	16.20 (0.638)		

PART NUMBERING GUIDE								NOTES						
TFI	773	1600	28	A2	E3	M4	N	1) Critical rate of rise of off-state voltage						
1	2	3	4	5	6	7	8	Symbol of group	P2	K2	E2	A2		
1. TFI — Fast Thyristor								$(dv_D/dt)_{crit}, V/\mu s$	200	320	500	1000		
TFIS — Fast Thyristor with Distributed Amplified Gate.								2) Turn-on time						
Design version								Symbol of group	M4	K4	H4	C4		
3. Mean on-state current, A								$t_{gt}, \mu s$	2.50	3.20	4.00	6.30		
4. Voltage code								3) Turn-off time ($dv_D/dt=50 V/\mu s$)						
5. Critical rate of rise of off-state voltage								Symbol of group	E3		C3			
6. Group of turn-off time ($dv_D/dt=50 V/\mu s$)								$t_{qr}, \mu s$	50.0		63.0			
7. Group of turn-on time														
8. Ambient conditions: N – normal; T – tropical														

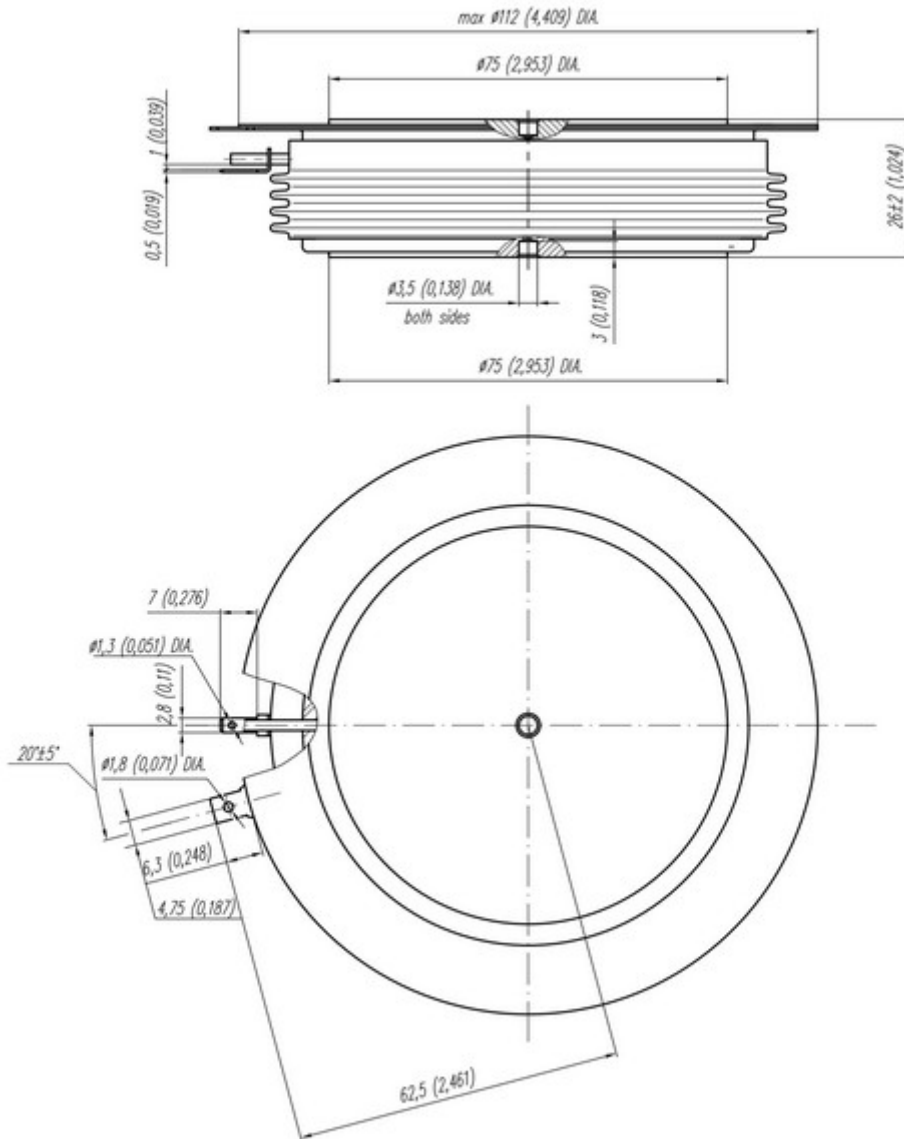

All dimensions in millimeters (inches)

The information contained herein is confidential and protected by Copyright. In the interest of product improvement, Proton-Electrotex reserves the right to change data sheet without notice.

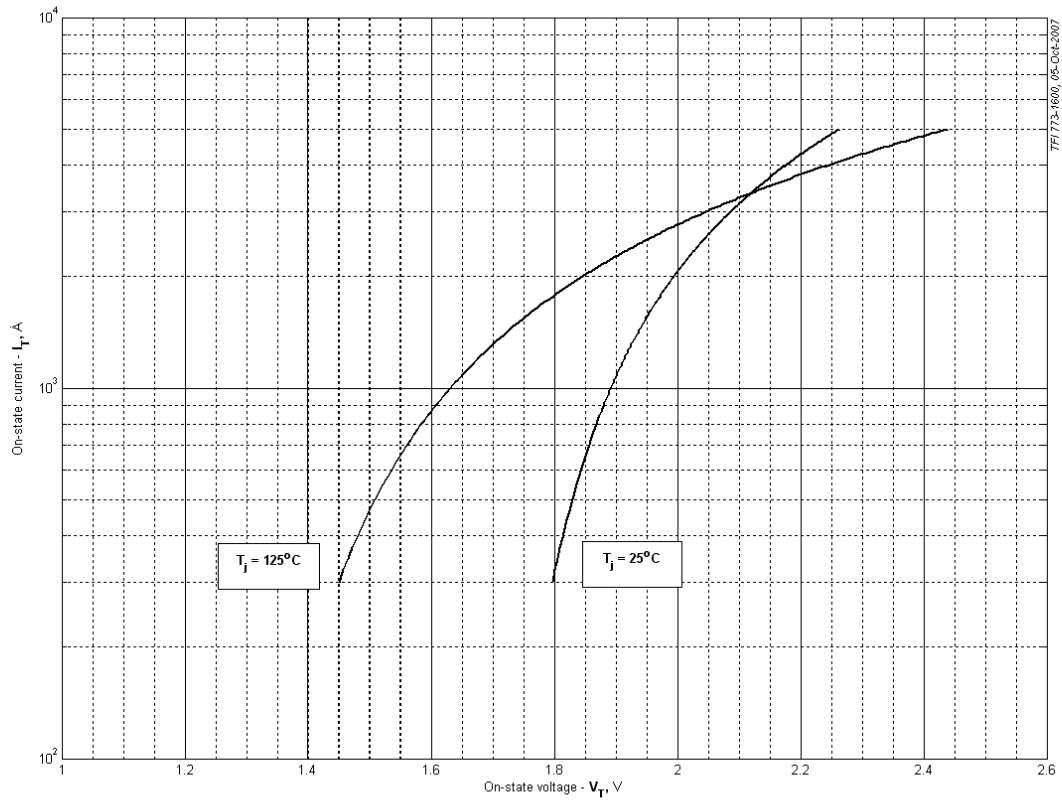

Fig 1 – On-state characteristics of Limit device

Analytical function for On-state characteristic:

$$V_T = A + B \cdot i_T + C \cdot \ln(i_T + 1) + D \cdot \sqrt{i_T}$$

	Coefficients	
	$T_j = 25^\circ\text{C}$	$T_j = T_{j\text{max}}$
A	1.663692	1.248421
B	0.047151	0.141128
C	-0.169918	-0.226937
D	0.298768	0.399026

On-state characteristic model (see Fig. 1).

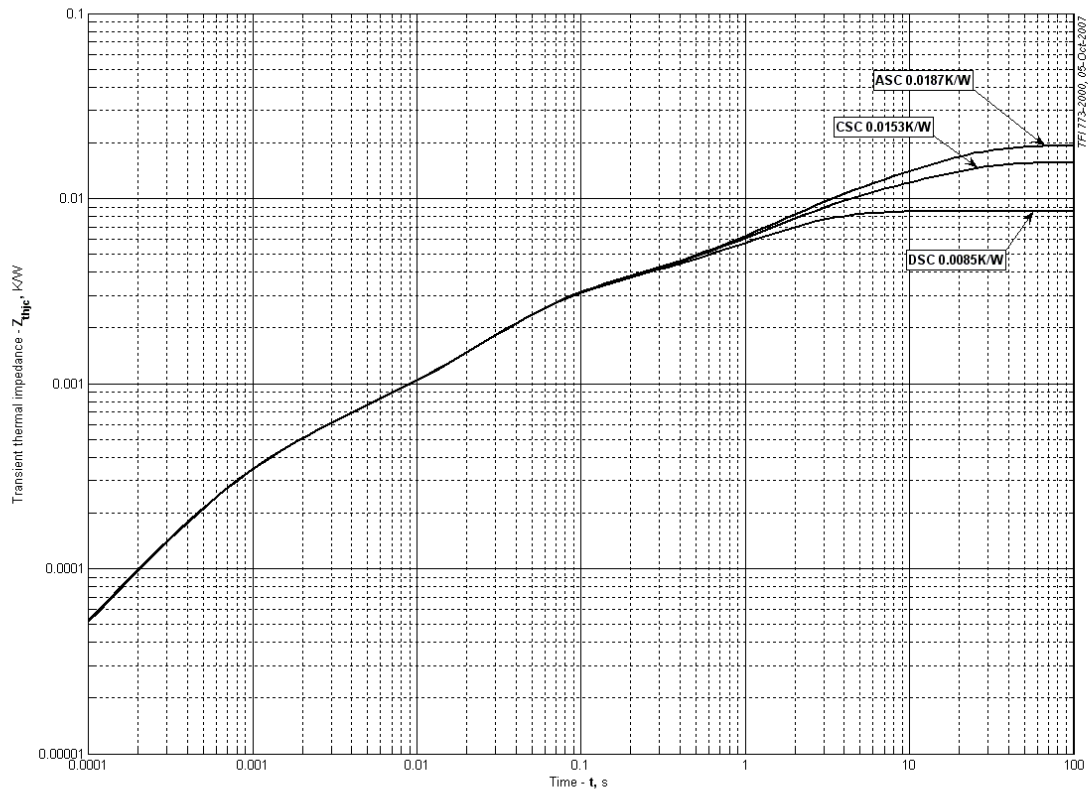

Fig 2 – Transient thermal impedance

Analytical function for Transient thermal impedance junction to case Z_{thjc} for DC:

$$Z_{thjc} = \sum_{i=1}^n R_i \left(1 - e^{-\frac{t}{\tau_i}} \right)$$

Where $i = 1$ to n , n is the number of terms in the series.

t = Duration of heating pulse in seconds.

Z_{thjc} = Thermal resistance at time t .

R_i = Amplitude of p_{th} term.

τ_i = Time constant of r_{th} term.

DC Double side cooled

i	1	2	3	4	5	6
R_i , K/W	0.002286	0.002114	0.0003311	0.0007163	0.0001912	0.002861
τ_i , s	2.118	0.04237	0.002023	0.1607	0.0005657	1.277

DC Anode side cooled

i	1	2	3	4	5	6
R_i , K/W	0.0109	0.004763	0.0007557	0.002278	0.0002742	0.0002673
τ_i , s	13.270	1.911	0.2725	0.04556	0.002662	0.0006884

DC Cathode side cooled

i	1	2	3	4	5	6
R_i , K/W	0.007262	0.004752	0.0007646	0.002283	0.0002732	0.0002688
τ_i , s	13.200	1.816	0.2756	0.04558	0.002679	0.0006907

Transient thermal impedance junction to case Z_{thjc} model (see Fig. 2).

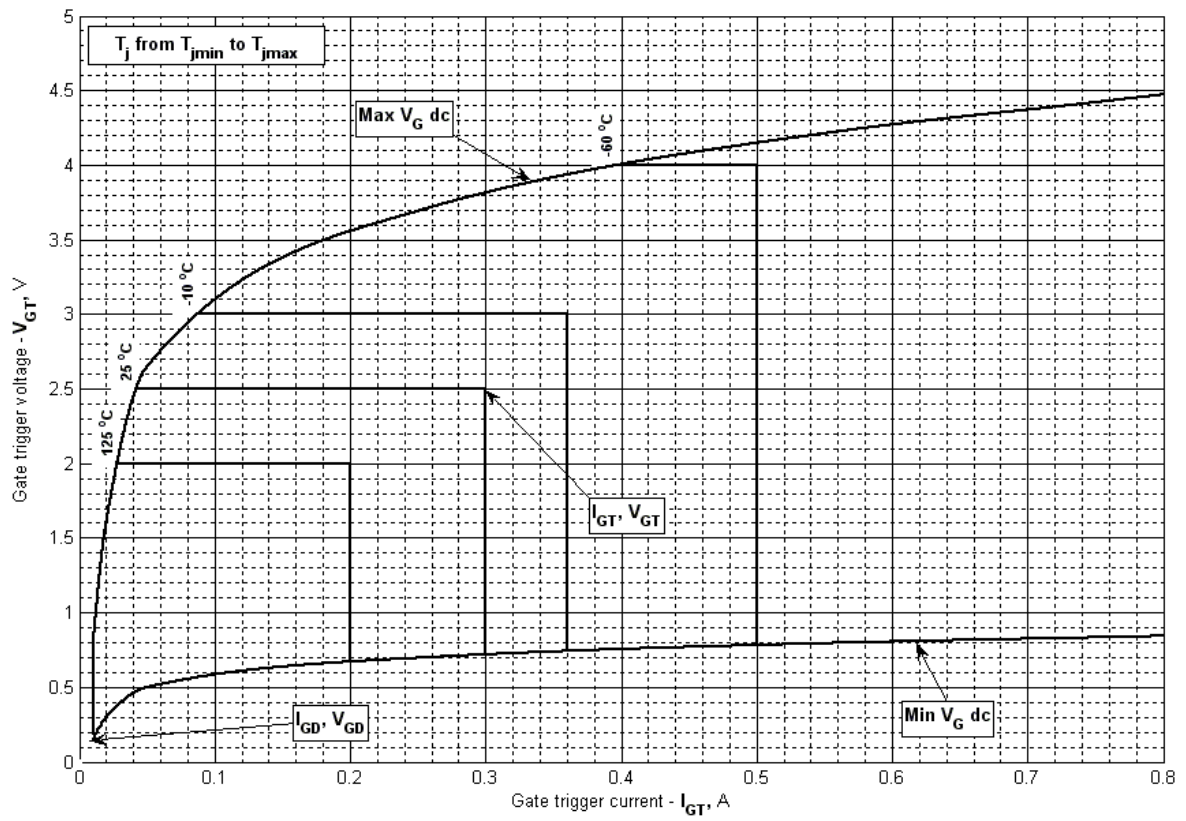

Fig 3 – Gate characteristics – Trigger limits

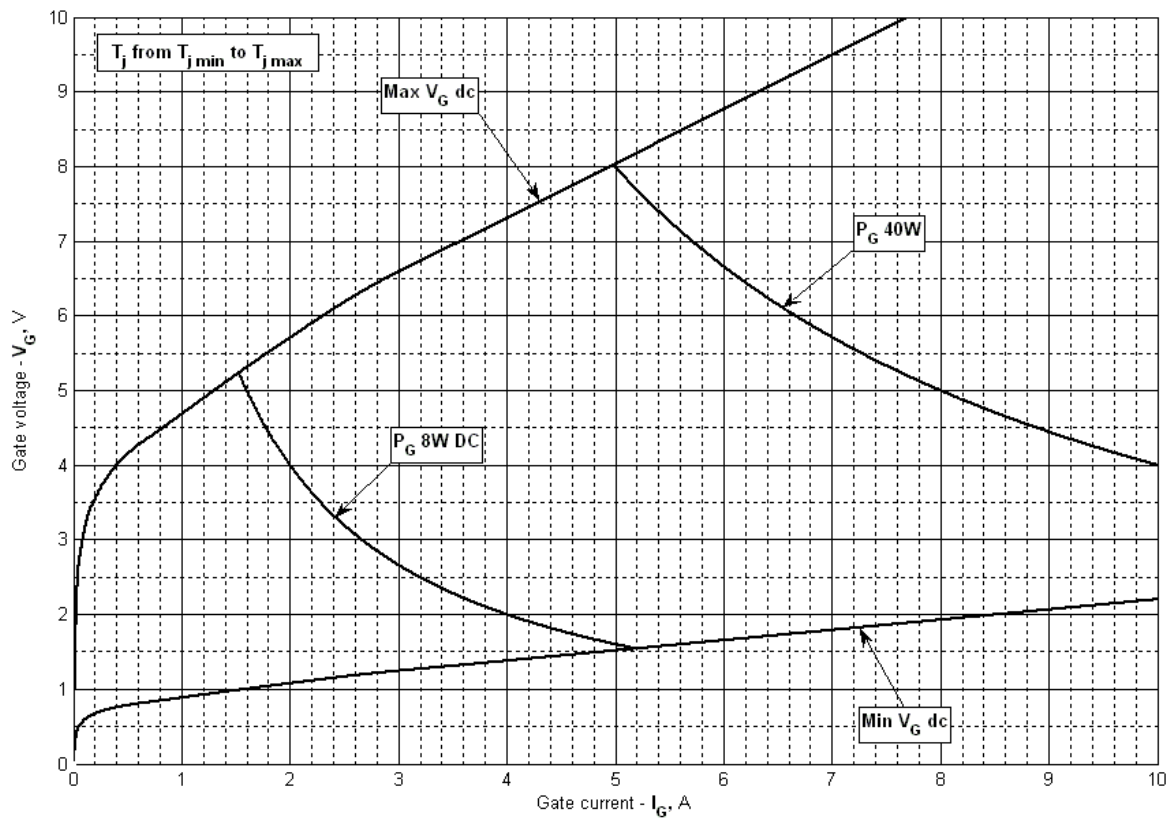

Fig 4 - Gate characteristics –Power curves

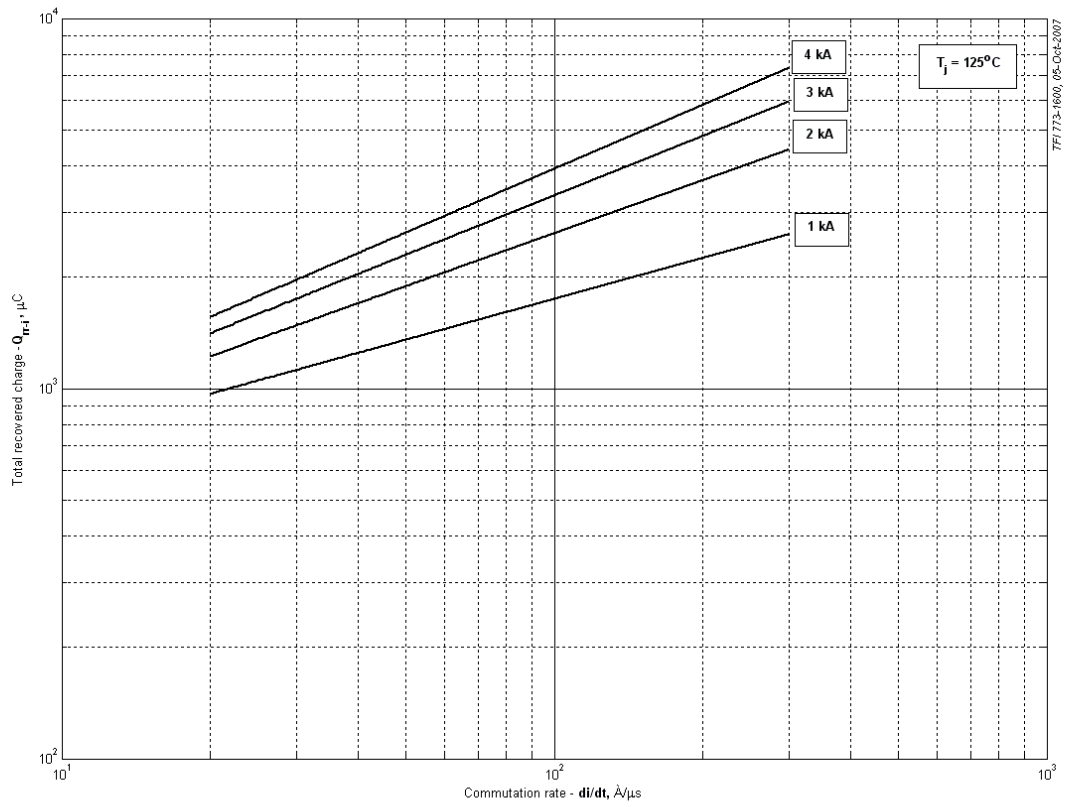

Fig 5 – Total recovered charge, Q_{rr-i} (integral)

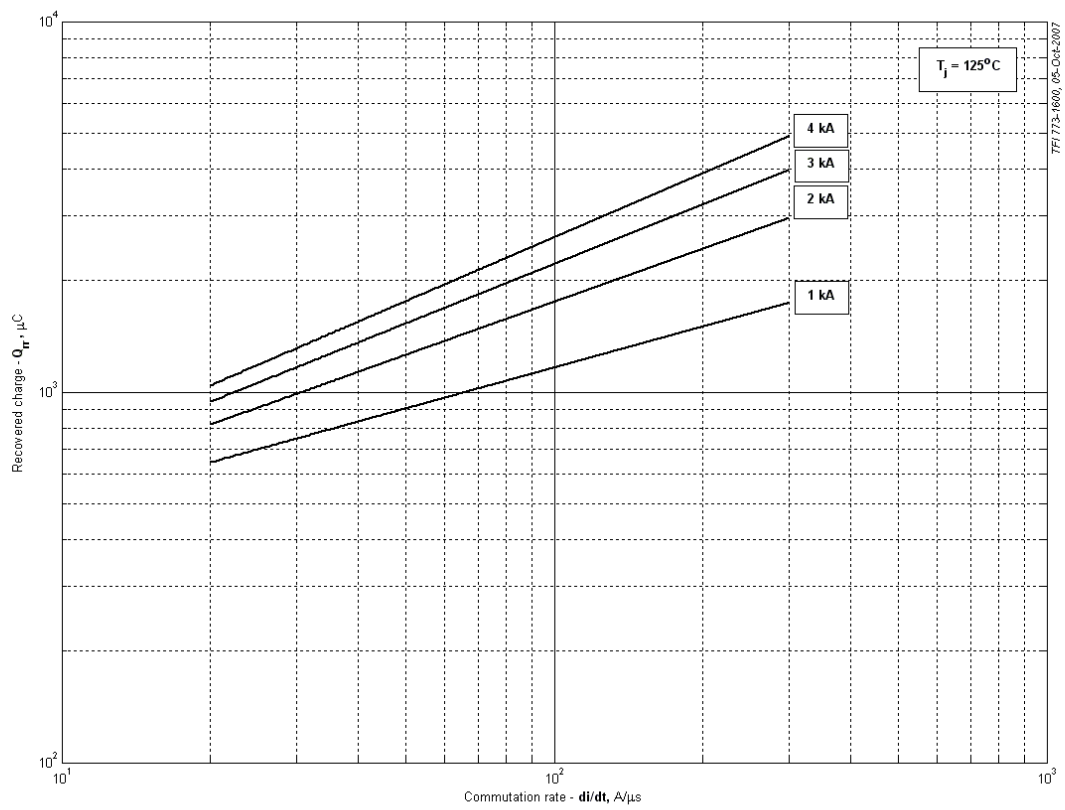

Fig 6 - Recovered charge, Q_{rr} (25% chord)

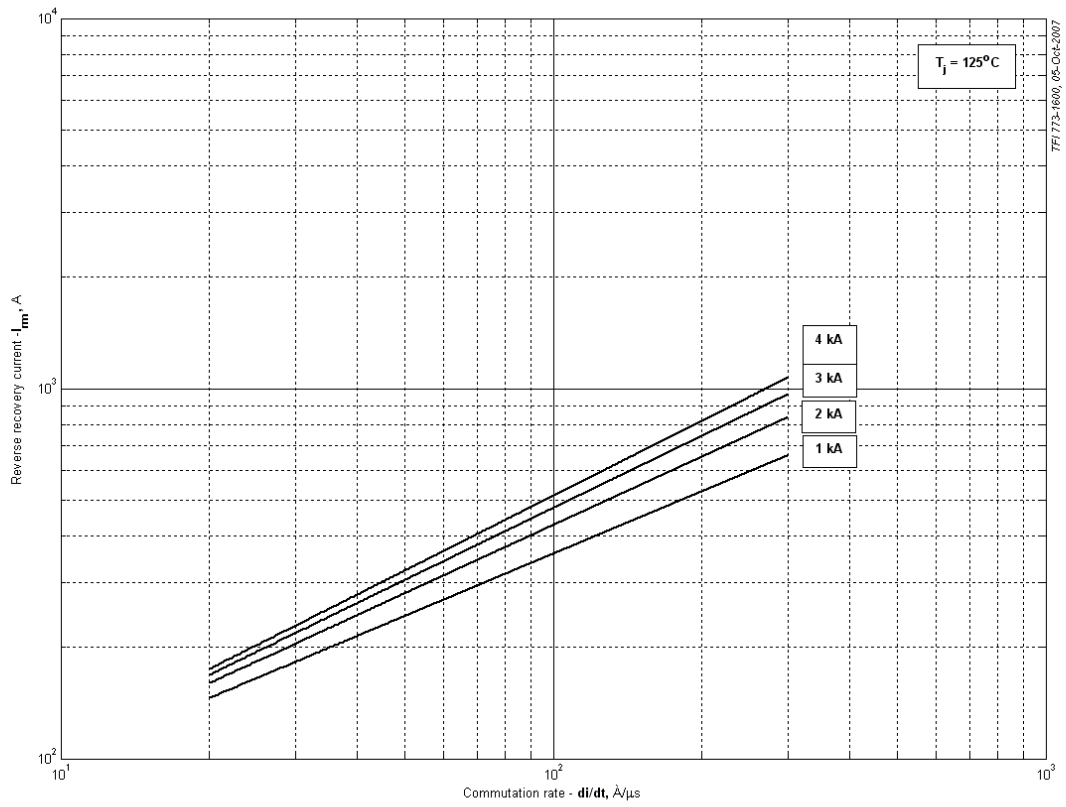

Fig 7 – Peak reverse recovery current, I_{rrm}

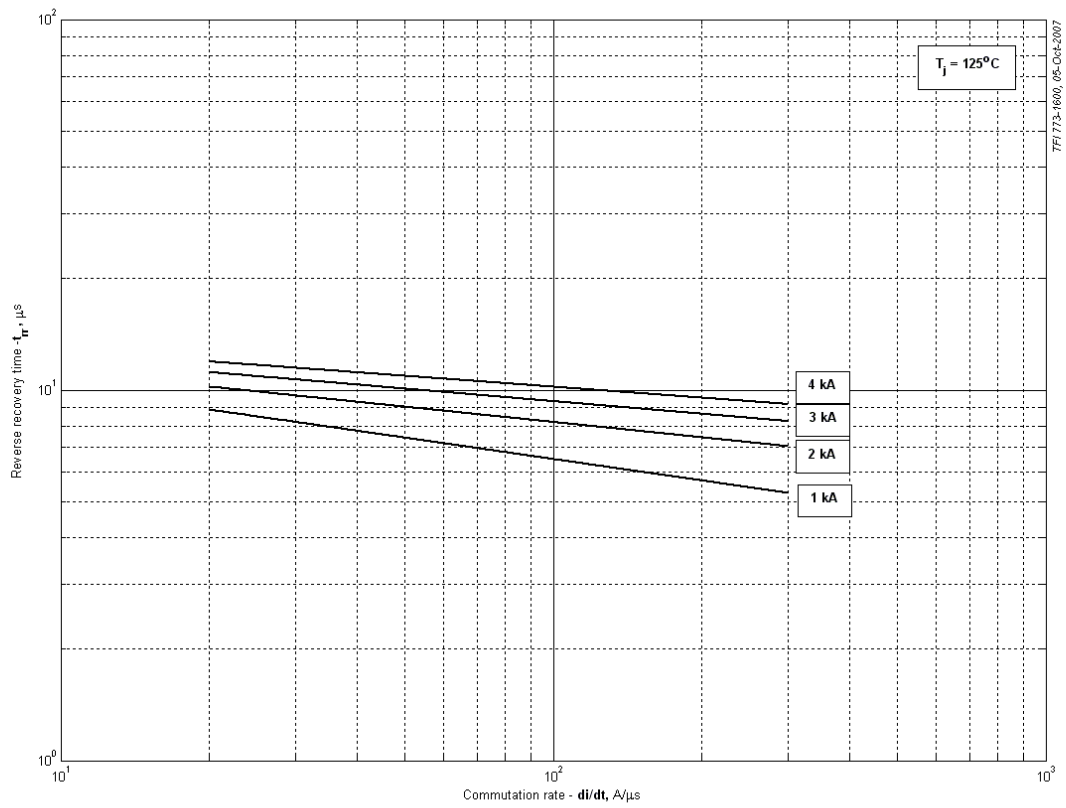

Fig 8 – Maximum recovery time, t_{rr} (25% chord)

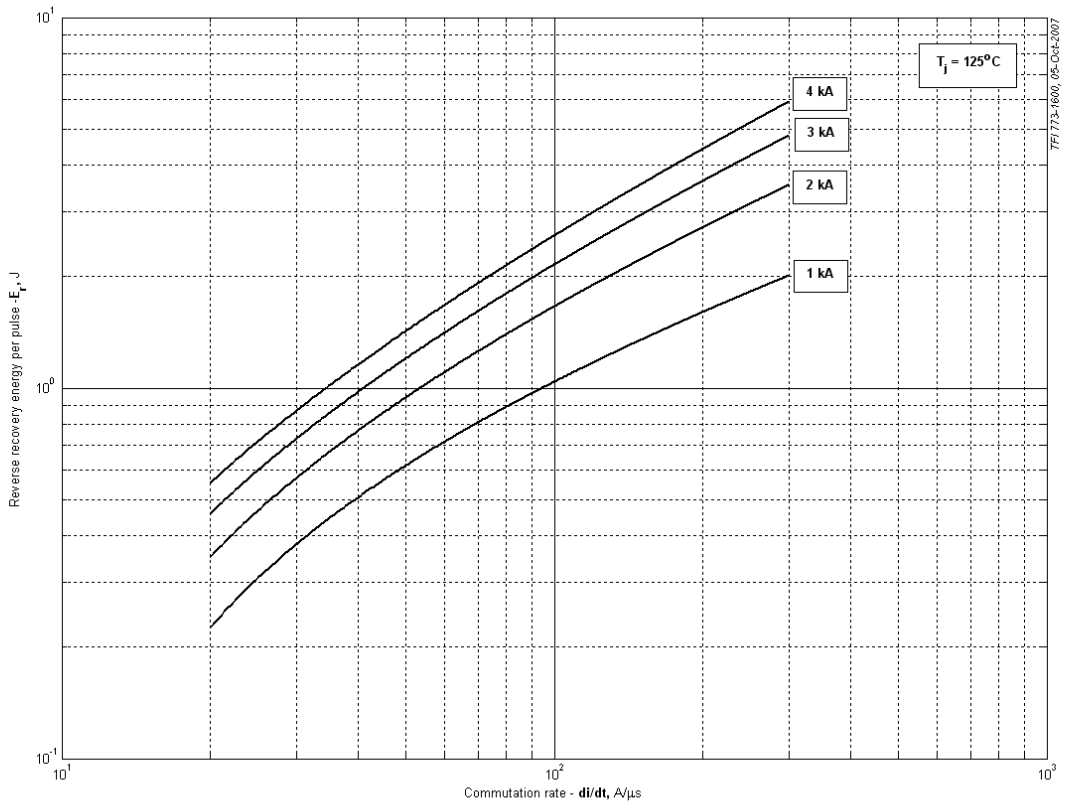

Fig 9 – Reverse recovery energy per pulse

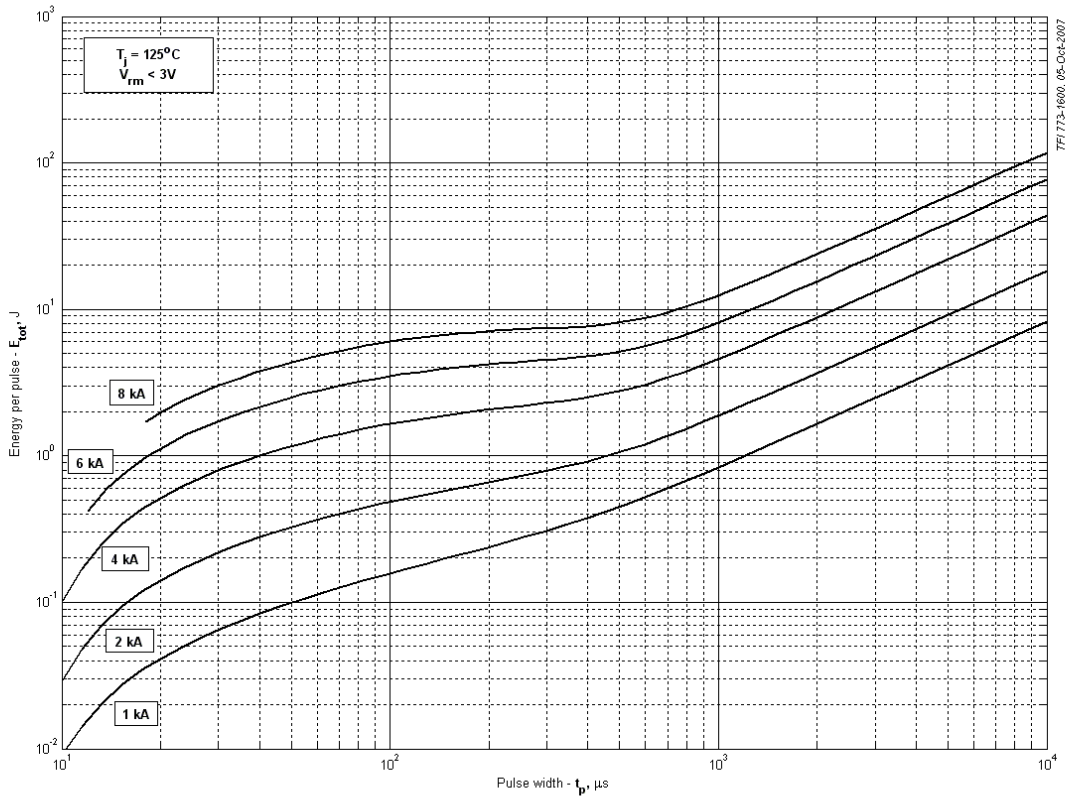

Fig 10 – Sine wave energy per pulse

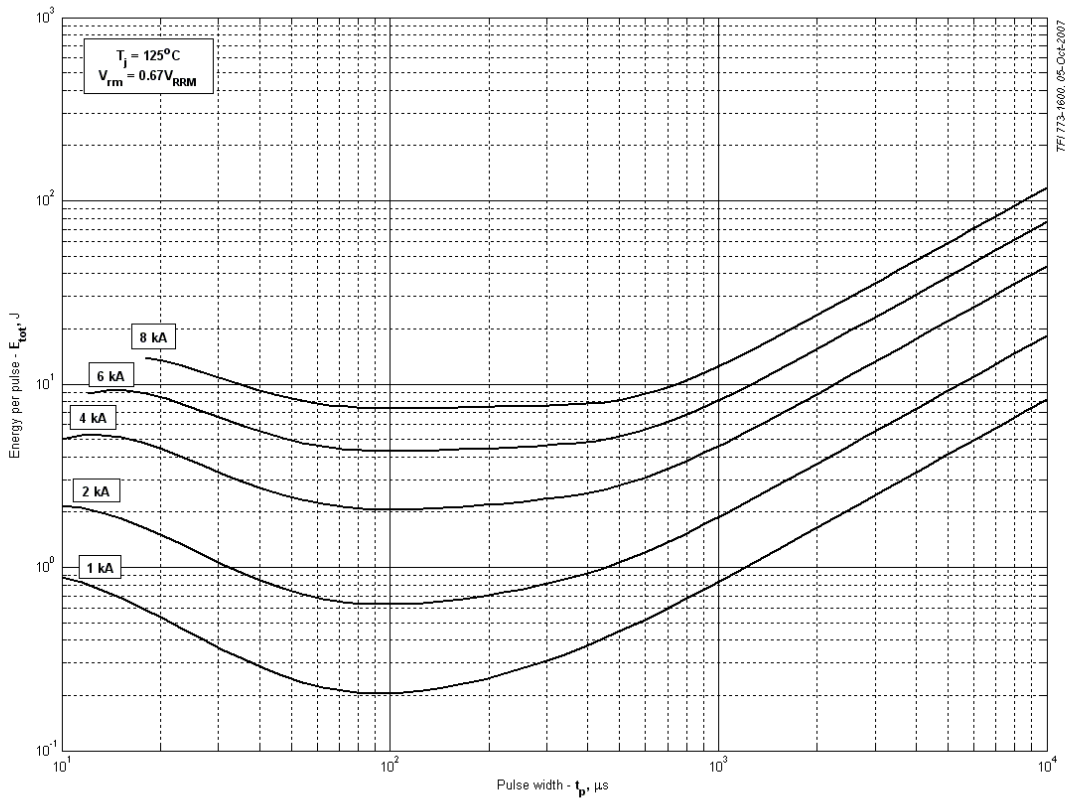

Fig 11 – Sine wave energy per pulse

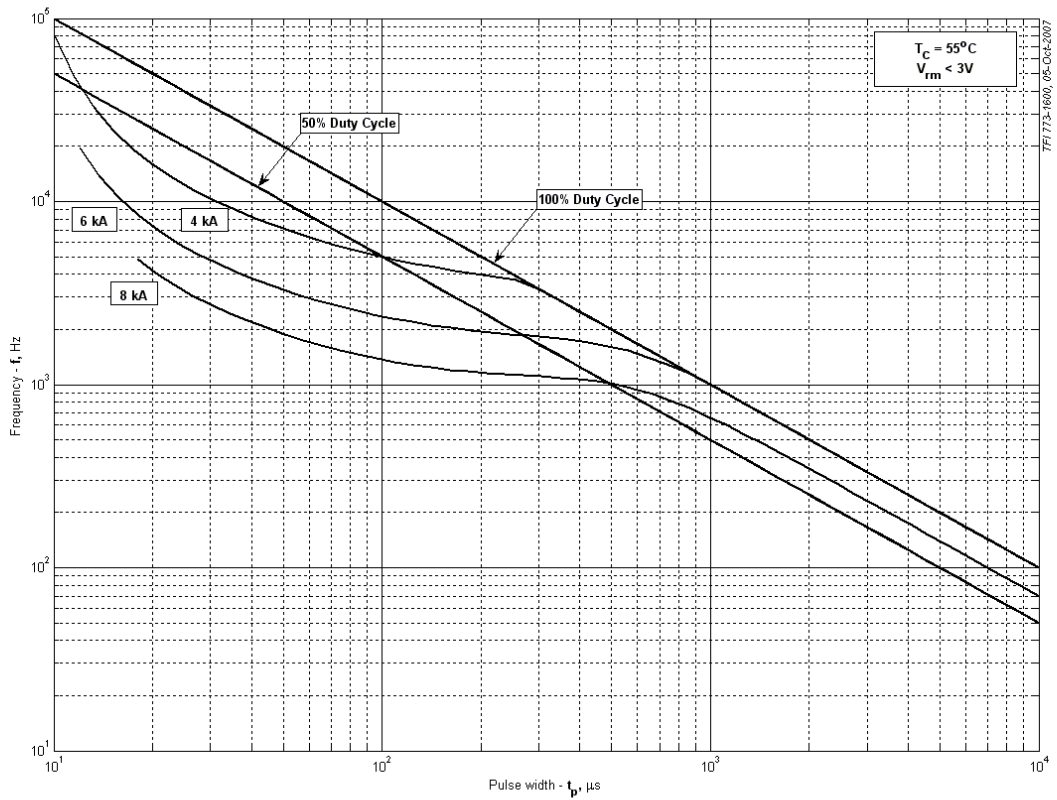

Fig 12 – Sine wave frequency ratings

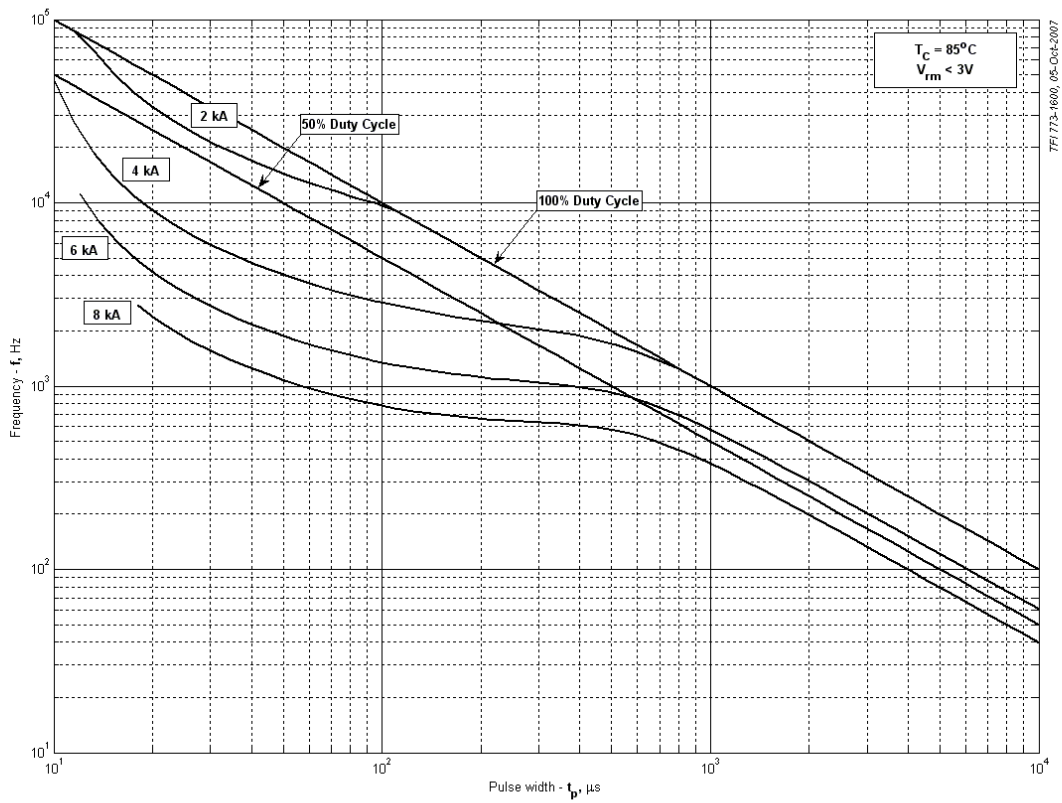

Fig 13 – Sine wave frequency ratings

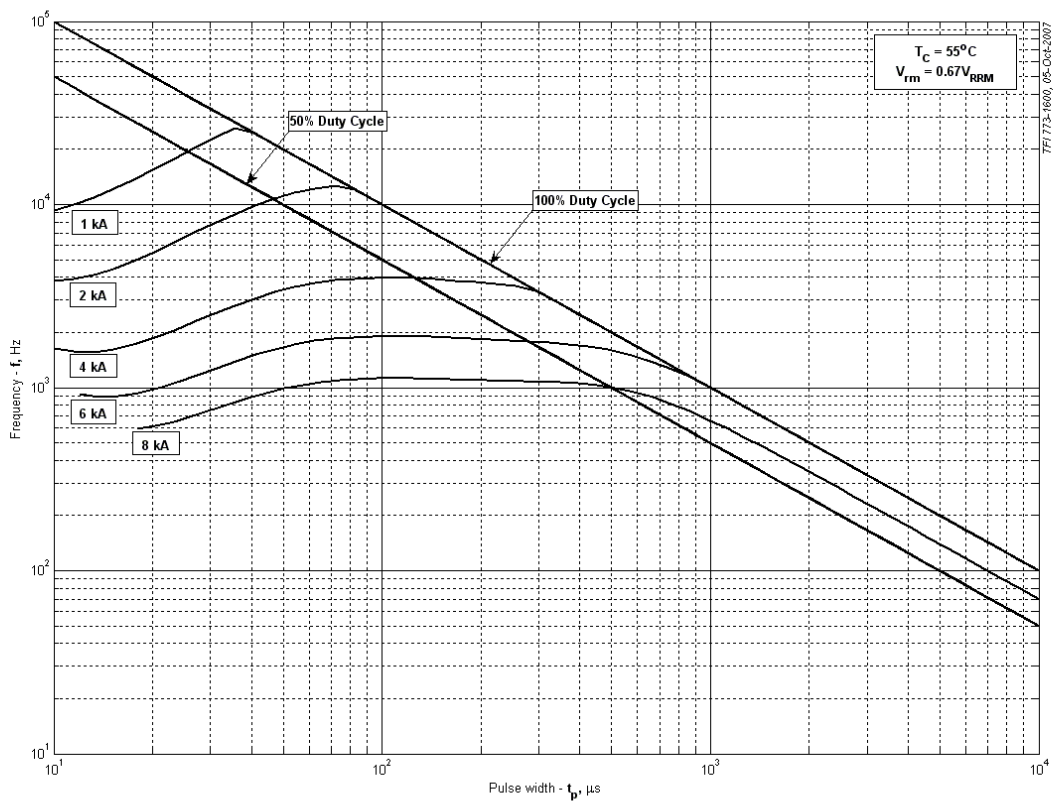

Fig 14 – Sine wave frequency ratings

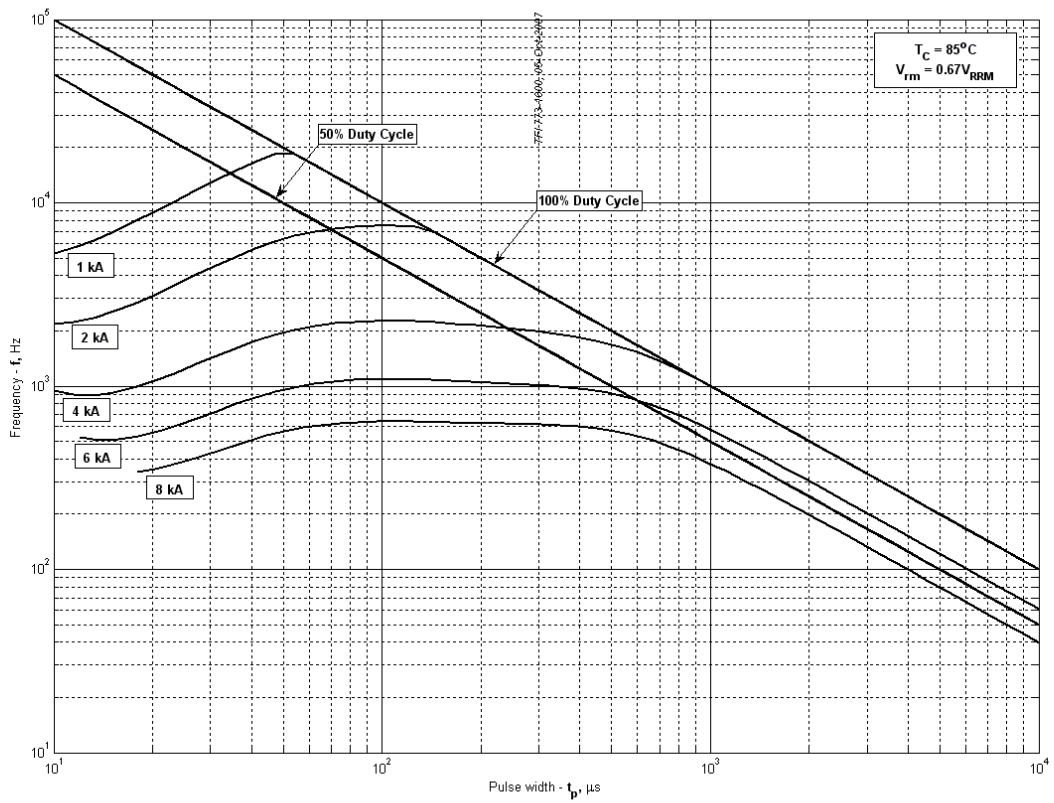

Fig 15 – Sine wave frequency ratings

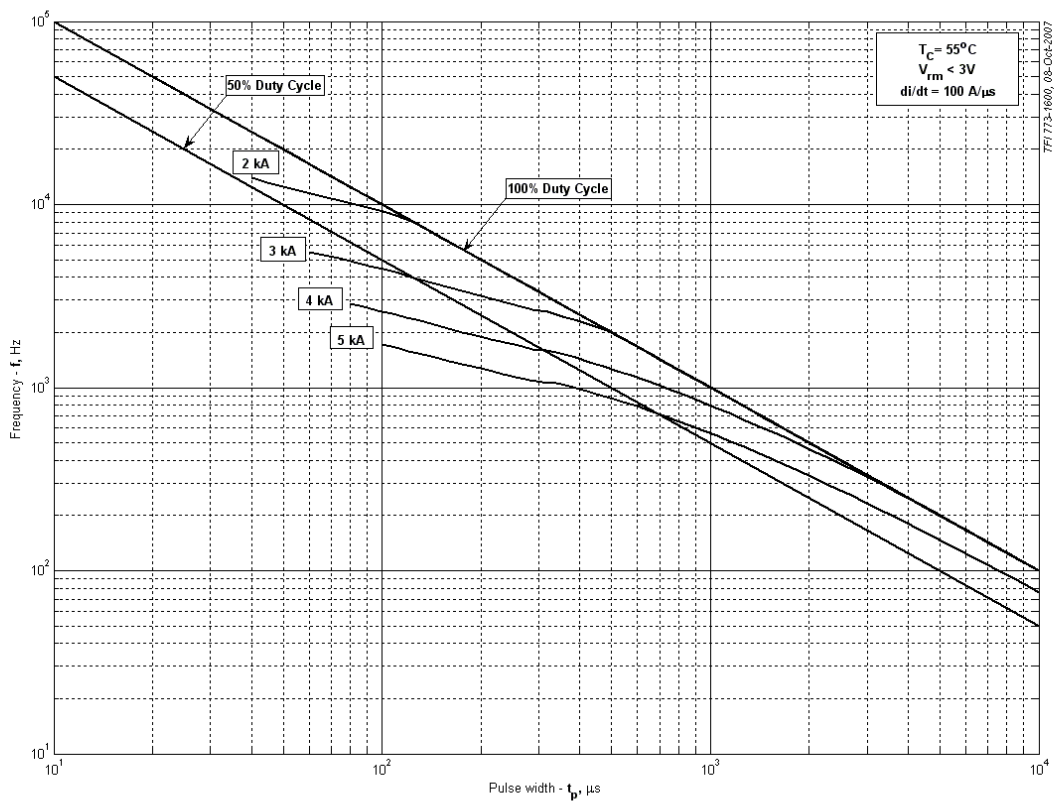

Fig 16 – Square wave frequency ratings

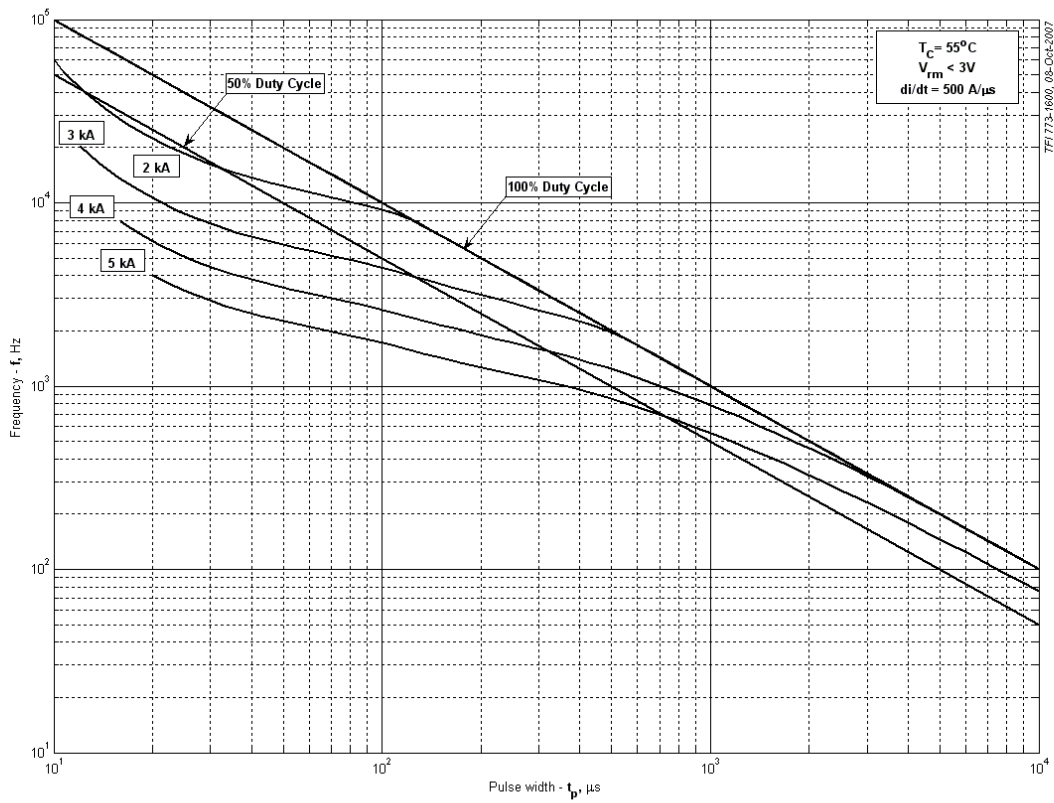

Fig 17 – Square wave frequency ratings

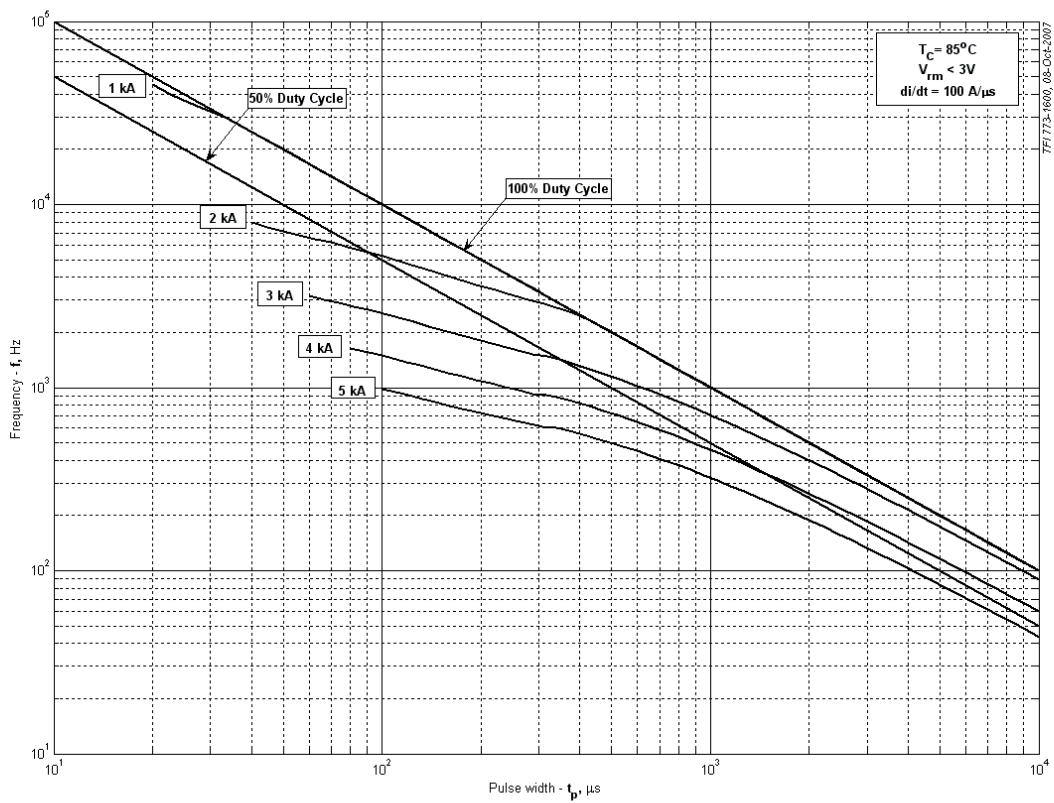

Fig 18 – Square wave frequency ratings

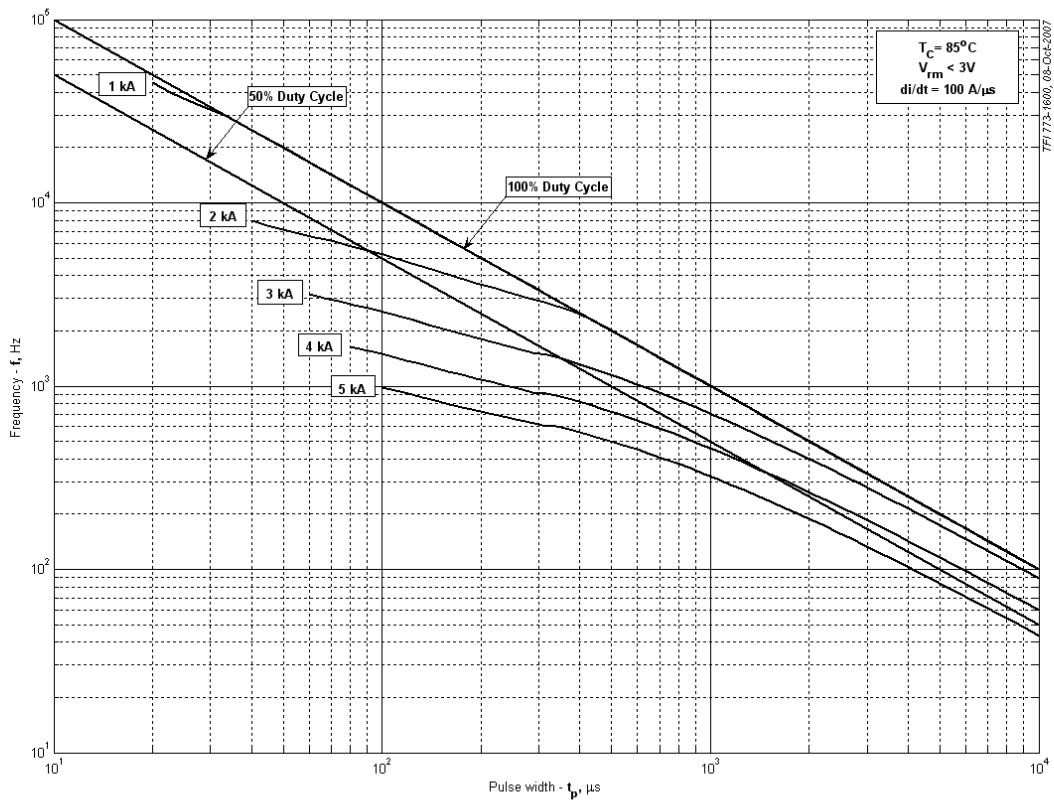

Fig 19 – Square wave frequency ratings

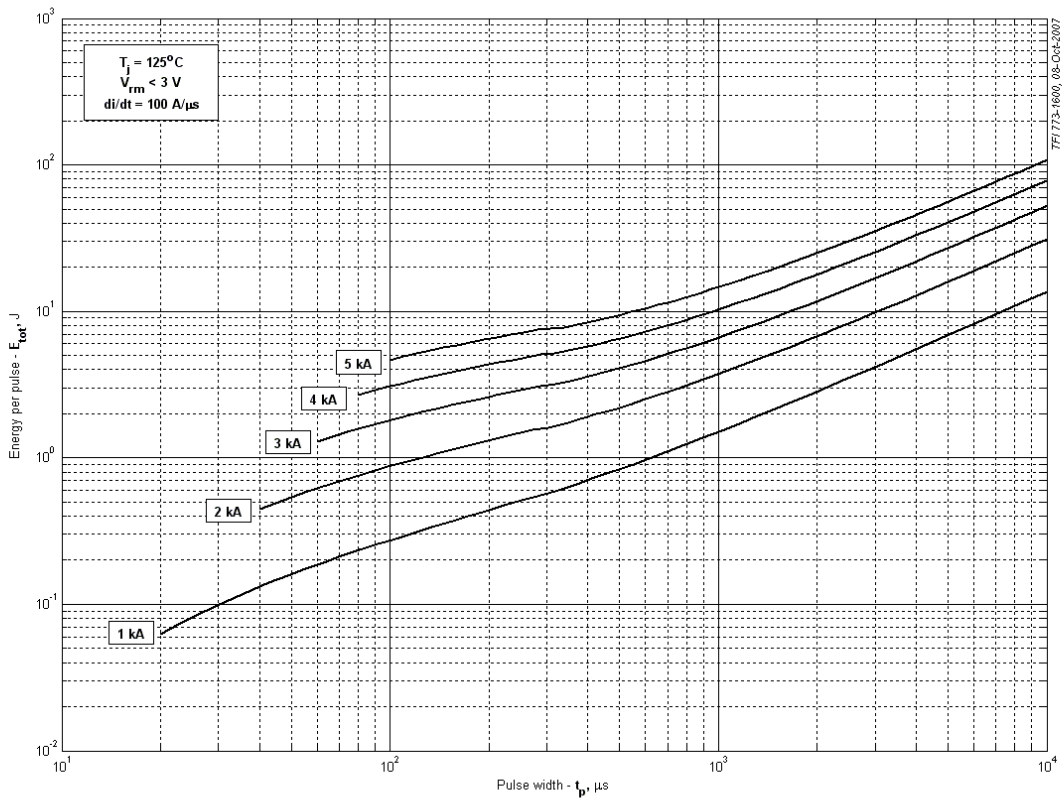

Fig 20 – Square wave energy per pulse

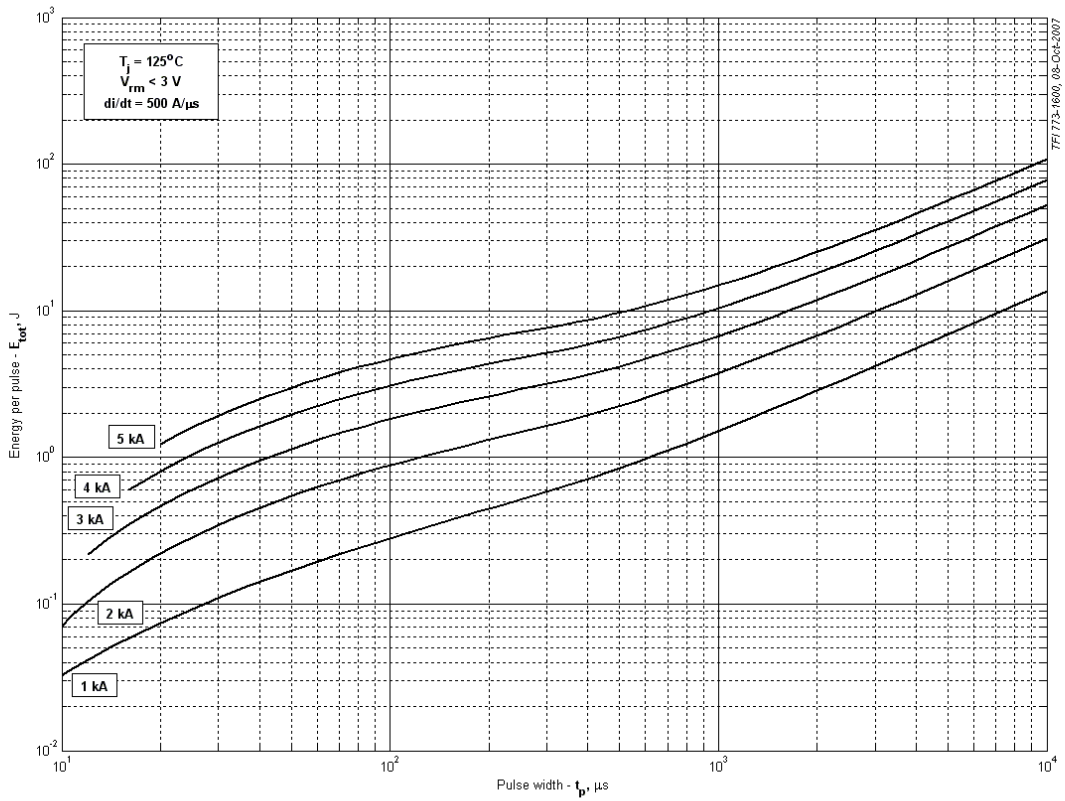

Fig 21 – Square wave energy per pulse

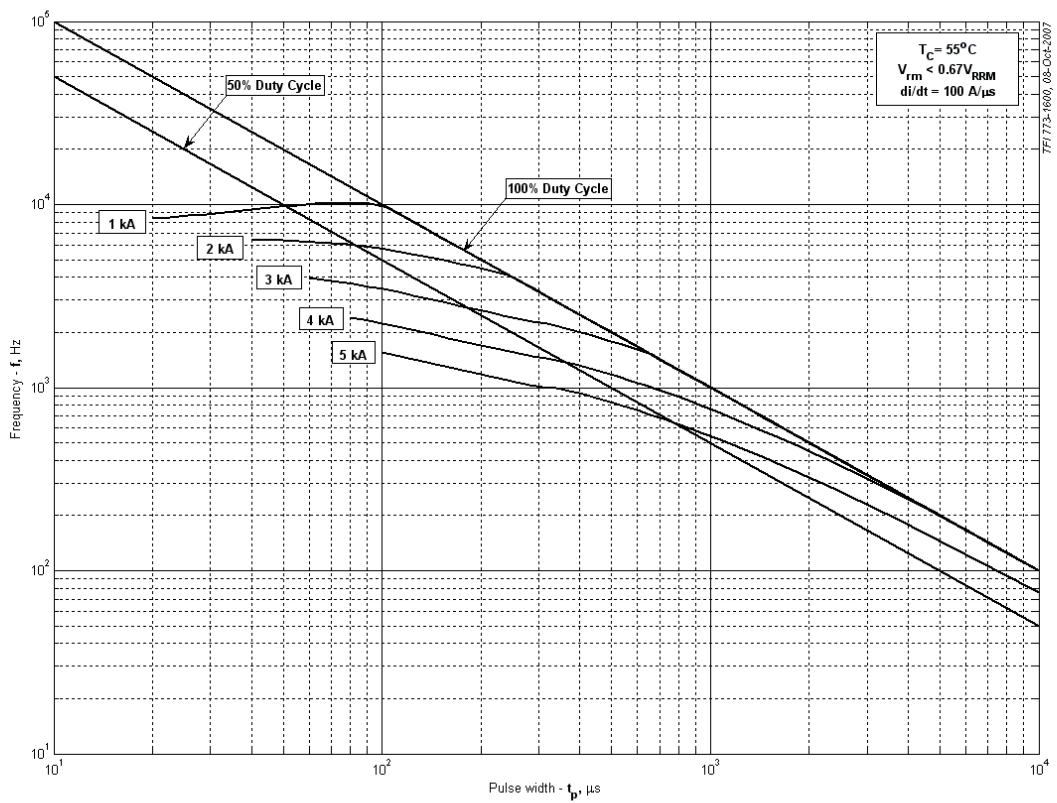

Fig 22 – Square wave frequency ratings

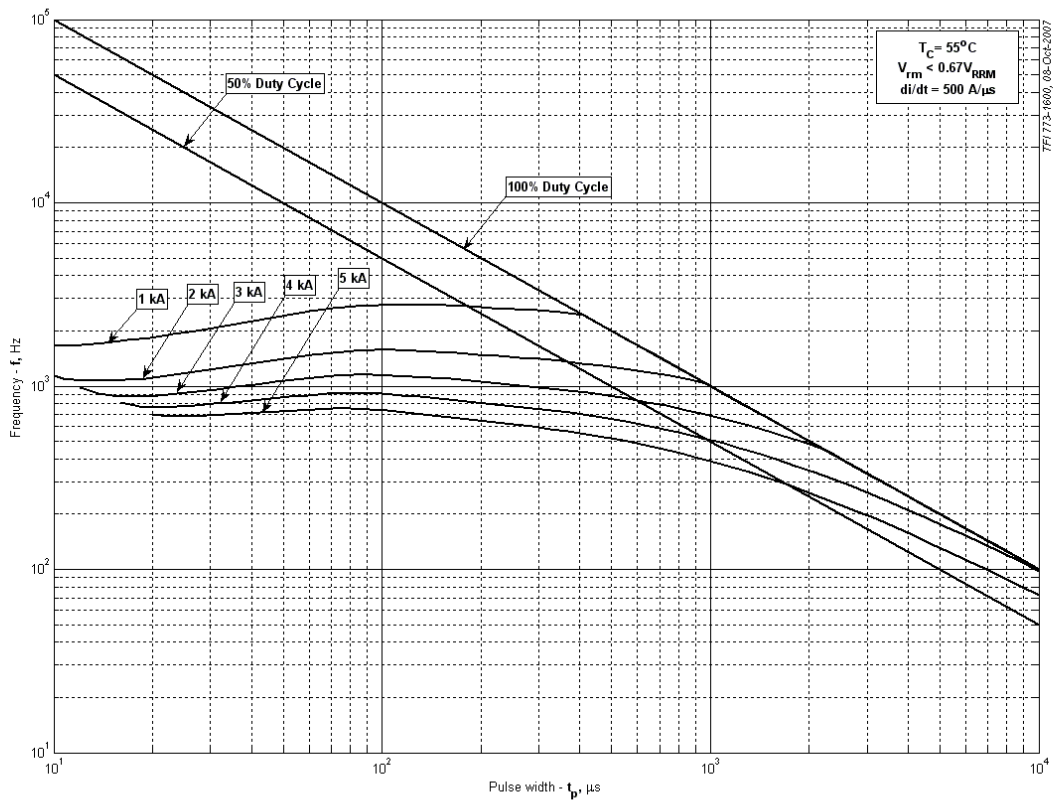

Fig 23 – Square wave frequency ratings

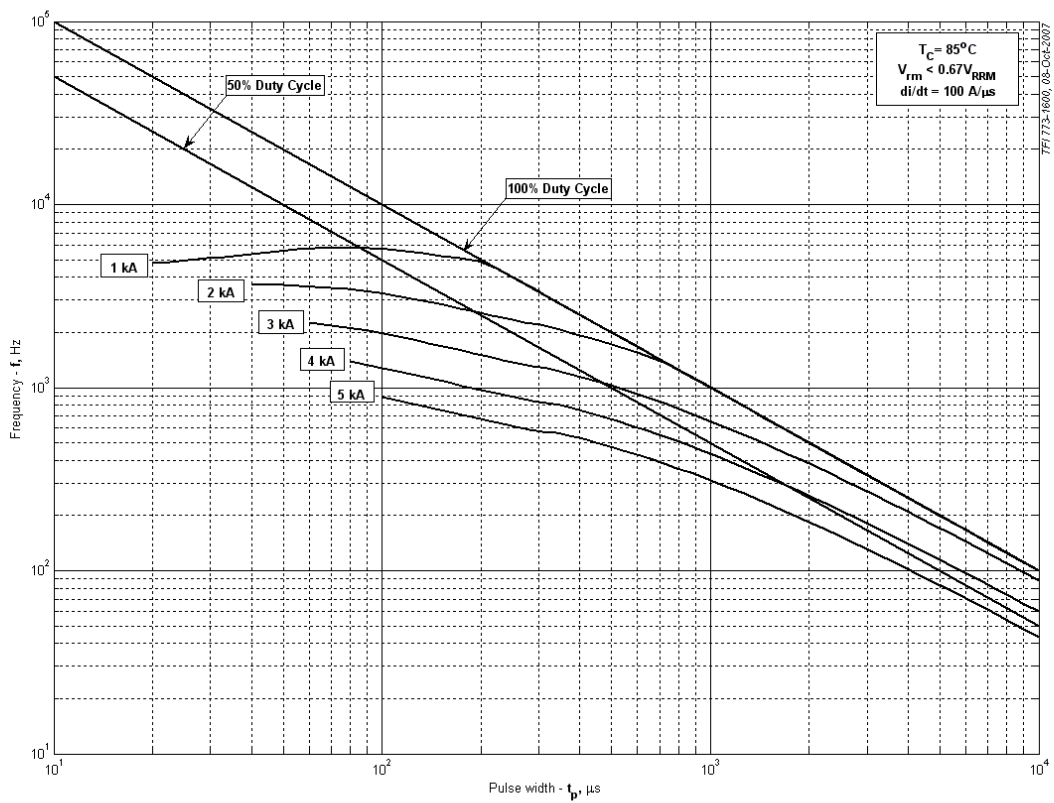

Fig 24 – Square wave frequency ratings

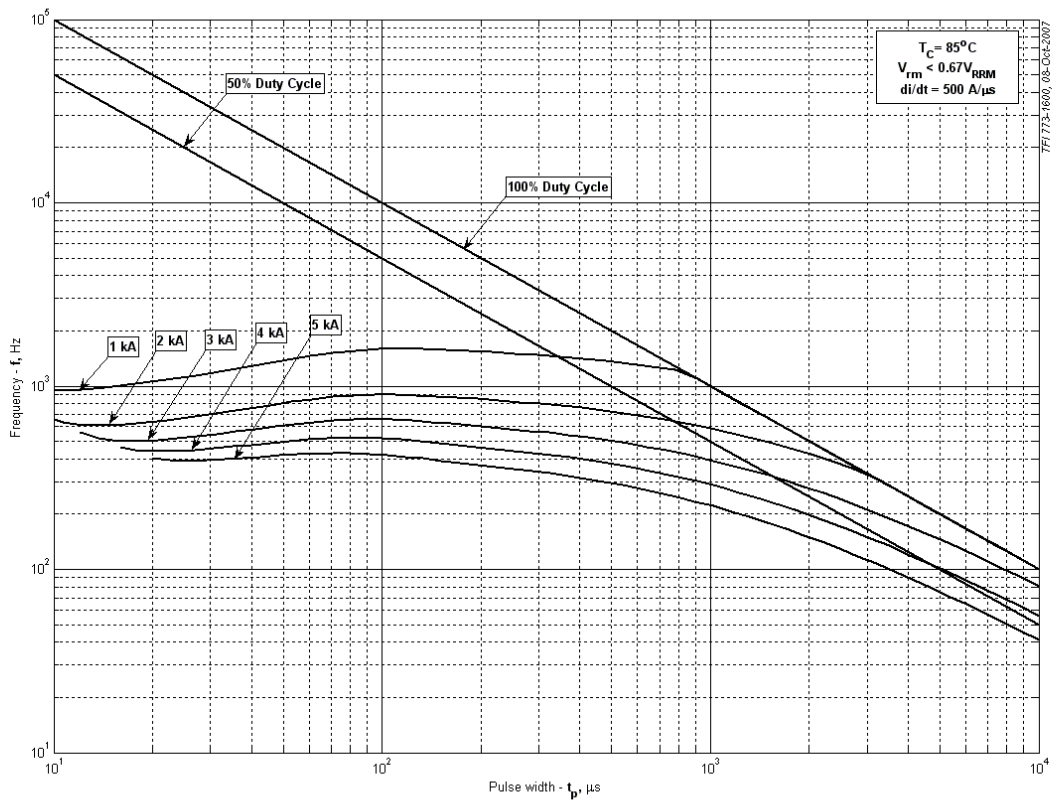

Fig 25 – Square wave frequency ratings

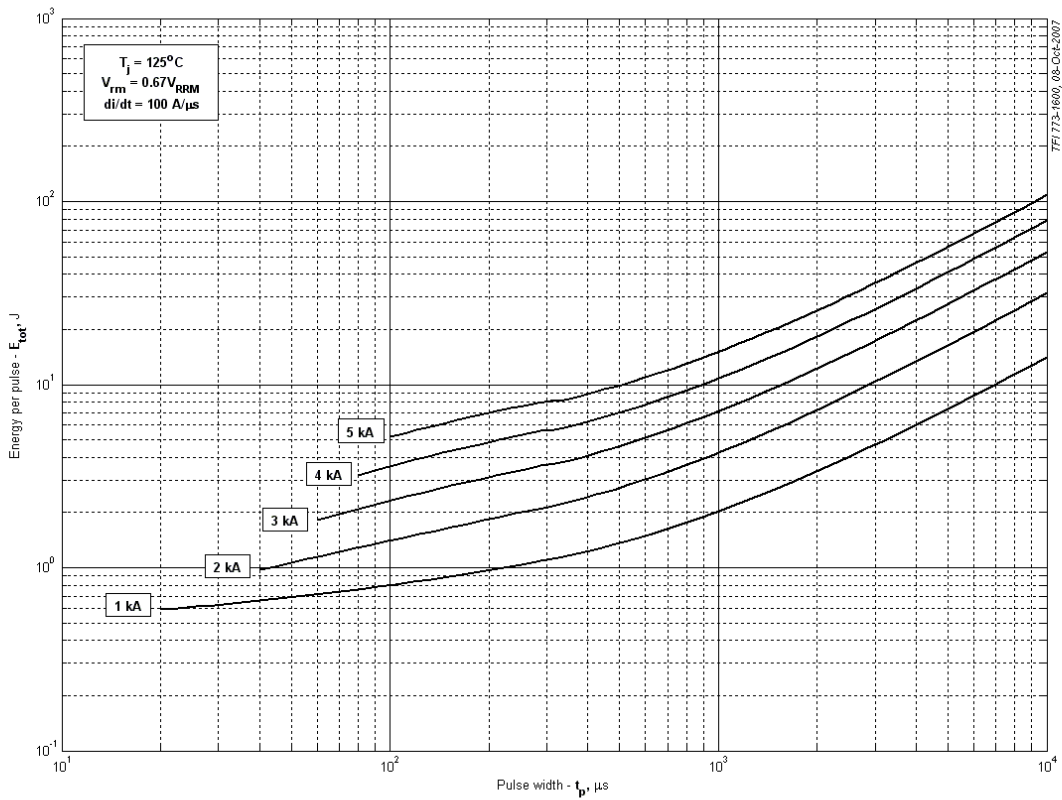

Fig 26 – Square wave energy per pulse

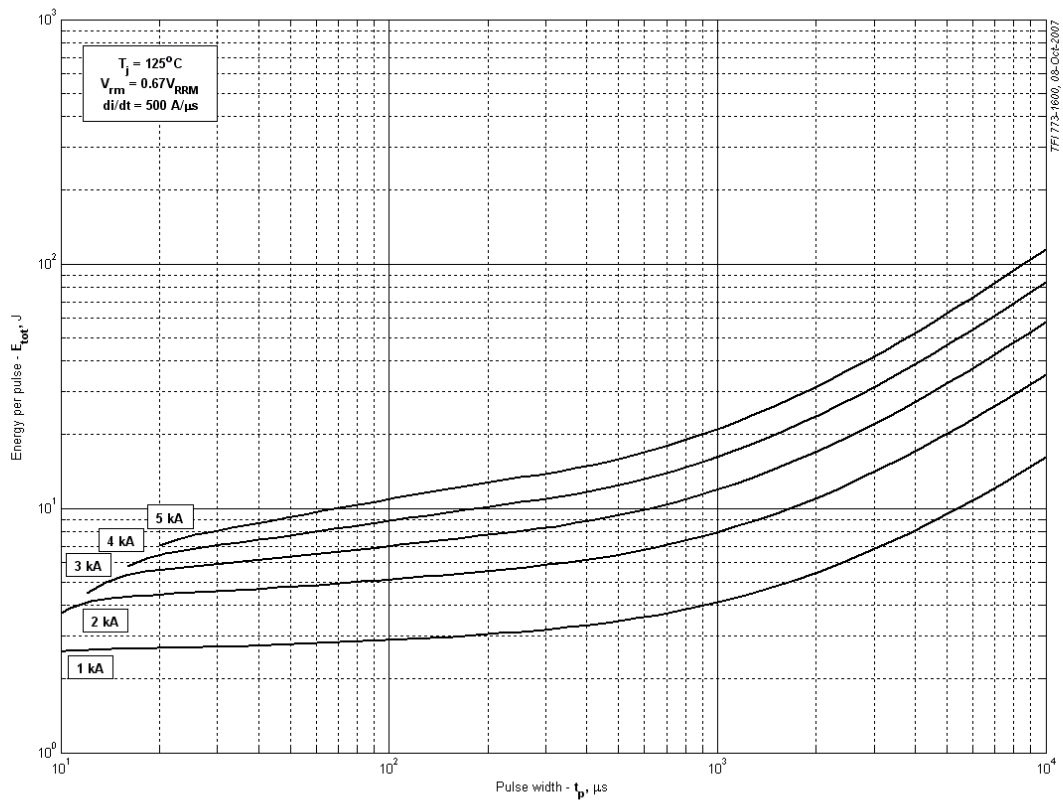

Fig 27 – Square wave energy per pulse

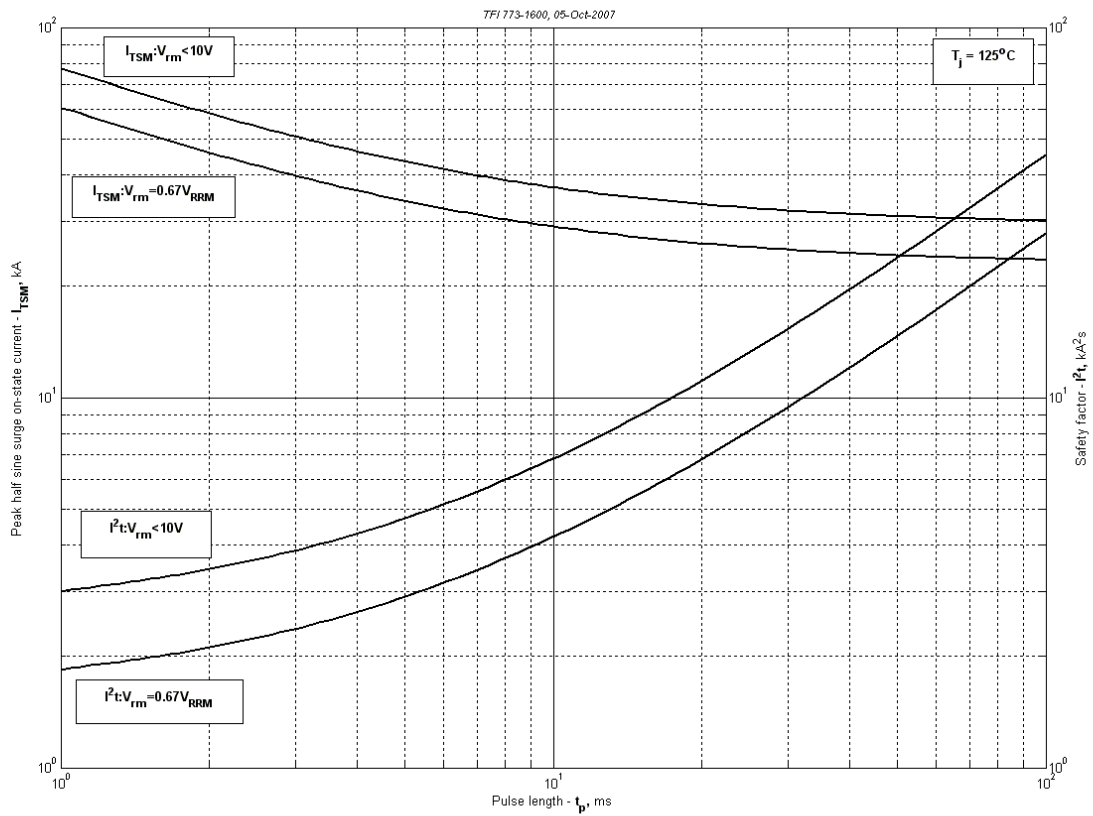

Fig 28 – Maximum surge and I^2t ratings

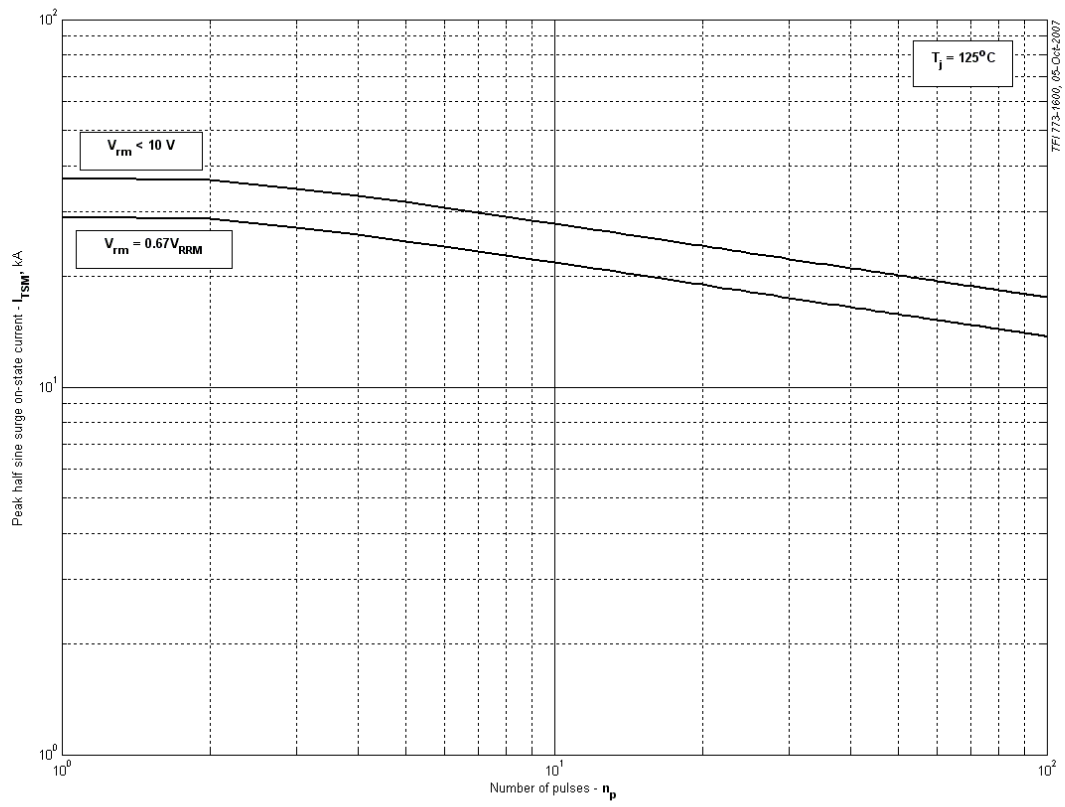

Fig 29 – Maximum surge ratings