



**Fast Thyristor
Type TFI643-400-22**

Low switching losses
Low reverse recovery charge
Distributed amplified gate for high di_T/dt

Mean on-state current	I_{TAV}	400 A
Repetitive peak off-state voltage	V_{DRM}	2000...2200 V
Repetitive peak reverse voltage	V_{RRM}	
Turn-off time	t_q	25.0, 32.0, 40.0, 50.0 μs
V_{DRM}, V_{RRM}, V	2000	2200
Voltage code	20	22
$T_j, ^\circ C$	-60...+125	

MAXIMUM ALLOWABLE RATINGS

Symbols and parameters		Units	Values	Test conditions
ON-STATE				
I_{TAV}	Mean on-state current	A	400 417 622	$T_c = 87^\circ C$; Double side cooled; $T_c = 85^\circ C$; Double side cooled; $T_c = 55^\circ C$; Double side cooled; 180° half-sine wave; 50 Hz
I_{TRMS}	RMS on-state current	A	628	$T_c = 87^\circ C$; Double side cooled; 180° half-sine wave; 50 Hz
I_{TSM}	Surge on-state current	kA	9.0 10.5	$T_j = T_{jmax}$ $T_j = 25^\circ C$ 180° half-sine wave; $t_p = 10$ ms; single pulse; $V_D = V_R = 0$ V; Gate pulse: $I_G = I_{FGM}$; $V_G = 20$ V; $t_{GP} = 50$ μs ; $di_G/dt = 1$ A/ μs
			9.5 11.0	$T_j = T_{jmax}$ $T_j = 25^\circ C$ 180° half-sine wave; $t_p = 8.3$ ms; single pulse; $V_D = V_R = 0$ V; Gate pulse: $I_G = I_{FGM}$; $V_G = 20$ V; $t_{GP} = 50$ μs ; $di_G/dt = 1$ A/ μs
I^2t	Safety factor	$A^2s \cdot 10^3$	400 550	$T_j = T_{jmax}$ $T_j = 25^\circ C$ 180° half-sine wave; $t_p = 10$ ms; single pulse; $V_D = V_R = 0$ V; Gate pulse: $I_G = I_{FGM}$; $V_G = 20$ V; $t_{GP} = 50$ μs ; $di_G/dt = 1$ A/ μs
			370 500	$T_j = T_{jmax}$ $T_j = 25^\circ C$ 180° half-sine wave; $t_p = 8.3$ ms; single pulse; $V_D = V_R = 0$ V; Gate pulse: $I_G = I_{FGM}$; $V_G = 20$ V; $t_{GP} = 50$ μs ; $di_G/dt = 1$ A/ μs
BLOCKING				
V_{DRM}, V_{RRM}	Repetitive peak off-state and Repetitive peak reverse voltages	V	2000...2200	$T_{jmin} < T_j < T_{jmax}$; 180° half-sine wave; 50 Hz; Gate open
V_{DSM}, V_{RSM}	Non-repetitive peak off-state and Non-repetitive peak reverse voltages	V	2100...2300	$T_{jmin} < T_j < T_{jmax}$; 180° half-sine wave; single pulse; Gate open
V_D, V_R	Direct off-state and Direct reverse voltages	V	$0.6 \cdot V_{DRM}$ $0.6 \cdot V_{RRM}$	$T_j = T_{jmax}$; Gate open

TRIGGERING				
I_{FGM}	Peak forward gate current	A	8	$T_j = T_{j\ max}$
V_{RGM}	Peak reverse gate voltage	V	5	
P_G	Gate power dissipation	W	8	$T_j = T_{j\ max}$ for DC gate current
SWITCHING				
$(di_T/dt)_{crit}$	Critical rate of rise of on-state current non-repetitive ($f=1\ Hz$)	A/ μs	2000	$T_j = T_{j\ max}$; $V_D = 0.67 \cdot V_{DRM}$; $I_{TM} = 2500\ A$; Gate pulse: $I_G = 2\ A$; $V_G = 20\ V$; $t_{GP} = 50\ \mu s$; $di_G/dt = 2\ A/\mu s$
THERMAL				
T_{stg}	Storage temperature	$^{\circ}C$	-60...+50	
T_j	Operating junction temperature	$^{\circ}C$	-60...+125	
MECHANICAL				
F	Mounting force	kN	14.0...16.0	
a	Acceleration	m/s^2	50	Device clamped

CHARACTERISTICS

Symbols and parameters		Units	Values	Conditions	
ON-STATE					
V_{TM}	Peak on-state voltage, max	V	2.85	$T_j = 25\ ^{\circ}C$; $I_{TM} = 1256\ A$	
$V_{T(TO)}$	On-state threshold voltage, max	V	1.821	$T_j = T_{j\ max}$;	
r_T	On-state slope resistance, max	$m\Omega$	0.976	$0.5\ \pi\ I_{TAV} < I_T < 1.5\ \pi\ I_{TAV}$	
I_H	Holding current, max	mA	500	$T_j = 25\ ^{\circ}C$; $V_D = 12\ V$; Gate open	
BLOCKING					
I_{DRM}, I_{RRM}	Repetitive peak off-state and Repetitive peak reverse currents, max	mA	100	$T_j = T_{j\ max}$; $V_D = V_{DRM}$; $V_R = V_{RRM}$	
$(dv_D/dt)_{crit}$	Critical rate of rise of off-state voltage ¹⁾ , min	V/ μs	200, 320, 500, 1000, 1600, 2000, 2500	$T_j = T_{j\ max}$; $V_D = 0.67 \cdot V_{DRM}$; Gate open	
TRIGGERING					
V_{GT}	Gate trigger direct voltage, max	V	3.00 2.50 1.50	$T_j = T_{j\ min}$ $T_j = 25\ ^{\circ}C$ $T_j = T_{j\ max}$	$V_D = 12\ V$; $I_D = 3\ A$; Direct gate current
I_{GT}	Gate trigger direct current, max	mA	500 300 150	$T_j = T_{j\ min}$ $T_j = 25\ ^{\circ}C$ $T_j = T_{j\ max}$	
V_{GD}	Gate non-trigger direct voltage, min	V	0.35	$T_j = T_{j\ max}$; $V_D = 0.67 \cdot V_{DRM}$;	
I_{GD}	Gate non-trigger direct current, min	mA	55.00	Direct gate current	
SWITCHING					
t_{gd}	Delay time, max	μs	0.90	$T_j = 25\ ^{\circ}C$; $V_D = 1000\ V$; $I_{TM} = I_{TAV}$; $di/dt = 200\ A/\mu s$;	
t_{gt}	Turn-on time ²⁾ , max	μs	1.60, 2.00, 2.50, 3.20	Gate pulse: $I_G = 2\ A$; $V_G = 20\ V$; $t_{GP} = 50\ \mu s$; $di_G/dt = 2\ A/\mu s$	
t_q	Turn-off time ³⁾ max	μs	25.0, 32.0, 40.0, 50.0	$dv_D/dt = 50\ V/\mu s$;	
			32.0, 40.0, 50.0, 63.0	$dv_D/dt = 200\ V/\mu s$;	
Q_{rr}	Total recovered charge, max	μC	300	$T_j = T_{j\ max}$; $I_{TM} = 400\ A$;	
t_{rr}	Reverse recovery time, typ	μs	5.0	$di_R/dt = -50\ A/\mu s$;	
I_{rrM}	Peak reverse recovery current, max	A	145	$V_R = 100\ V$	

THERMAL					
R_{thjc}	Thermal resistance, junction to case, max	°C/W	0.0340	Direct current	Double side cooled
R_{thjc-A}			0.0748		Anode side cooled
R_{thjc-K}			0.0612		Cathode side cooled
R_{thck}	Thermal resistance, case to heatsink, max	°C/W	0.0060	Direct current	
MECHANICAL					
w	Weight, max	g	240		
D_s	Surface creepage distance	mm (inch)	19.44 (0.765)		
D_a	Air strike distance	mm (inch)	12.10 (0.476)		

PART NUMBERING GUIDE								NOTES																																											
TFI	643	400	22	A2	E3	K4	N	¹⁾ Critical rate of rise of off-state voltage <table border="1"> <thead> <tr> <th>Symbol of Group</th> <th>P2</th> <th>K2</th> <th>E2</th> <th>A2</th> <th>T1</th> <th>P1</th> <th>M1</th> </tr> </thead> <tbody> <tr> <td>$(dv_D/dt)_{crit}$, V/μs</td> <td>200</td> <td>320</td> <td>500</td> <td>1000</td> <td>1600</td> <td>2000</td> <td>2500</td> </tr> </tbody> </table> ²⁾ Turn-on time <table border="1"> <thead> <tr> <th>Symbol of group</th> <th>T4</th> <th>P4</th> <th>M4</th> <th>K4</th> </tr> </thead> <tbody> <tr> <td>t_{gt}, μs</td> <td>1.60</td> <td>2.00</td> <td>2.50</td> <td>3.20</td> </tr> </tbody> </table> ³⁾ Turn-off time ($dv_D/dt=50$ V/μs) <table border="1"> <thead> <tr> <th>Symbol of group</th> <th>M3</th> <th>K3</th> <th>H3</th> <th>E3</th> </tr> </thead> <tbody> <tr> <td>t_{gr}, μs</td> <td>25.0</td> <td>32.0</td> <td>40.0</td> <td>50.0</td> </tr> </tbody> </table>								Symbol of Group	P2	K2	E2	A2	T1	P1	M1	$(dv_D/dt)_{crit}$, V/μs	200	320	500	1000	1600	2000	2500	Symbol of group	T4	P4	M4	K4	t_{gt} , μs	1.60	2.00	2.50	3.20	Symbol of group	M3	K3	H3	E3	t_{gr} , μs	25.0	32.0	40.0	50.0
Symbol of Group	P2	K2	E2	A2	T1	P1	M1																																												
$(dv_D/dt)_{crit}$, V/μs	200	320	500	1000	1600	2000	2500																																												
Symbol of group	T4	P4	M4	K4																																															
t_{gt} , μs	1.60	2.00	2.50	3.20																																															
Symbol of group	M3	K3	H3	E3																																															
t_{gr} , μs	25.0	32.0	40.0	50.0																																															
1	2	3	4	5	6	7	8																																												
1. TFI — fast inverter thyristor 2. Design version 3. Mean on-state current, A 4. Voltage code 5. Critical rate of rise of off-state voltage 6. Group of turn-off time ($dv_D/dt=50$ V/μs) 7. Group of turn-on time 8. Ambient conditions: N – normal; T – tropical																																																			

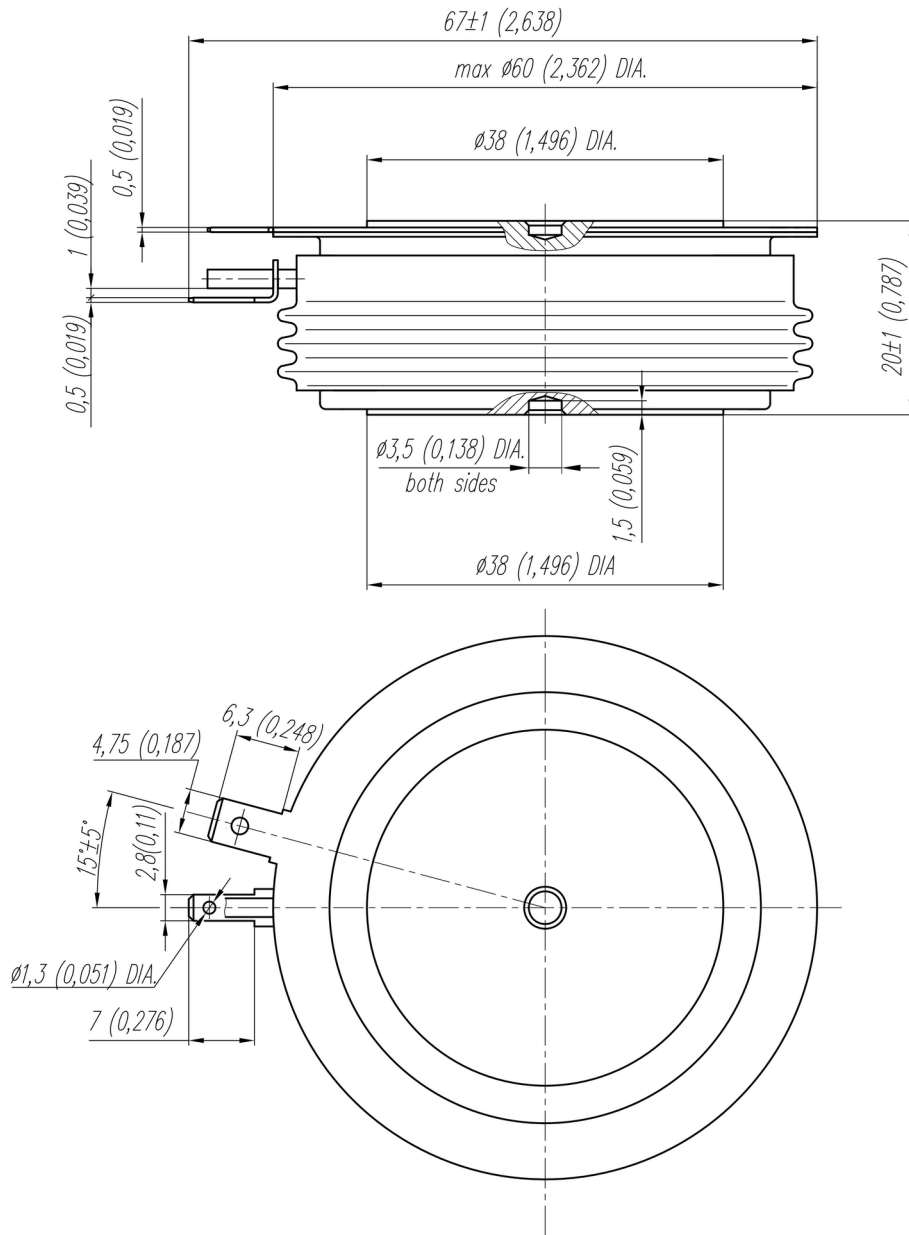

All dimensions in millimeters (inches)

The information contained herein is confidential and protected by Copyright.
 In the interest of product improvement, Proton-Electrotex reserves the right to change data sheet without notice.

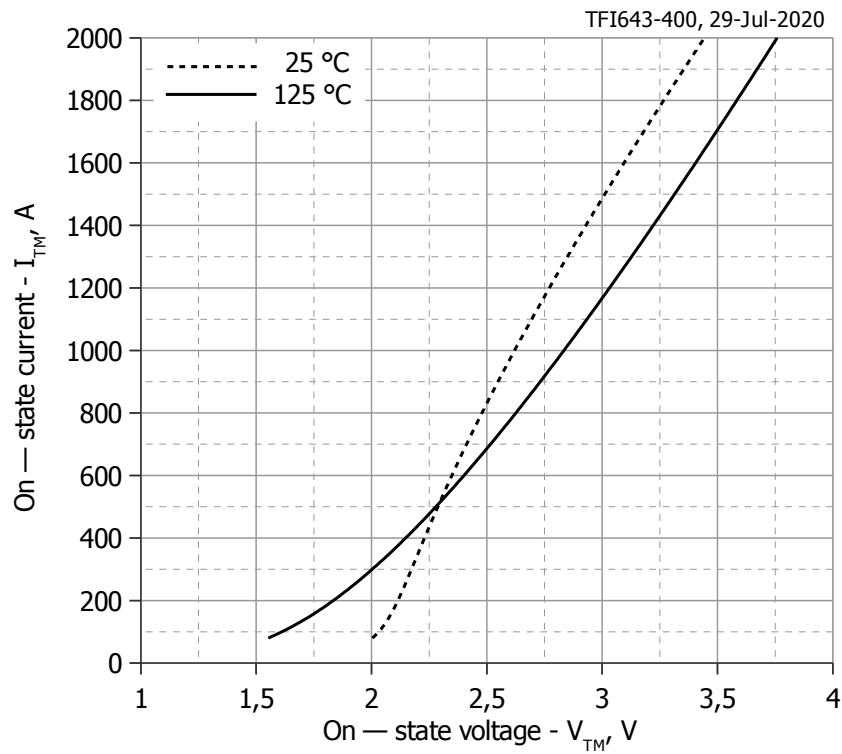

Analytical function for On-state characteristic:

$$V_T = A + B \cdot i_T + C \cdot \ln(i_T + 1) + D \cdot \sqrt{i_T}$$

	Coefficients for max curves	
	$T_j = 25^\circ\text{C}$	$T_j = T_{j\text{max}}$
A	1.09232826	0.77913388
B	0.00152003	0.00060140
C	0.32278801	0.12866310
D	-0.07027559	0.01785761

Fig. 1 On-state characteristics of Limit device

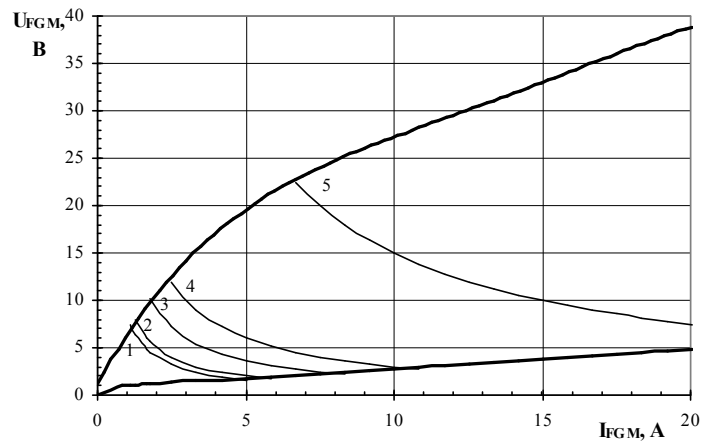

Maximum peak gate power loss

Position	On-Off time ratio	Gate pulse length, ms	Gate Pulse Power, W
1	1	DC	8
2	2	10	10
3	20	1	18
4	40	0.5	30
5	200	0.1	150

Fig. 2 Gate characteristics

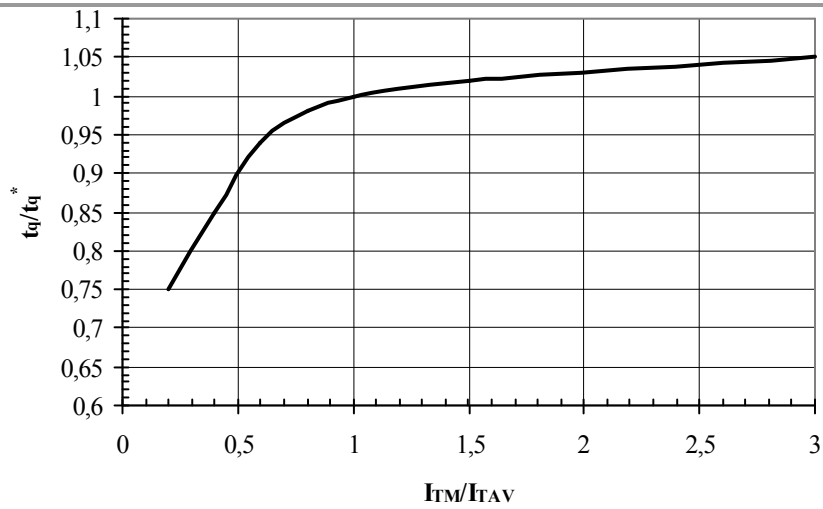

Fig. 3 Turn-off time t_q vs. On-state peak current I_{TM}

Conditions: $T_j=T_{j\ max}$; $di_R/dt=10\ A/\mu s$; $V_R=100\ V$; $dv_D/dt=50\ V/\mu s$; $V_D=0.67\cdot V_{DRM}$
 Typical changes of t_q are normalized to the t_q^* (t_q^* – see data sheet, $dv_D/dt=50\ V/\mu s$)

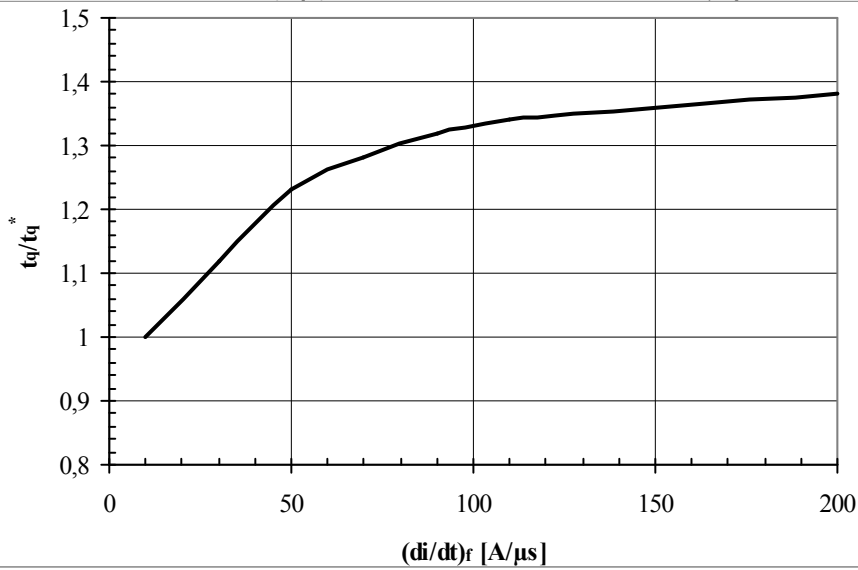

Fig. 4 Turn-off time t_q vs. Rate of fall of on-state current di_R/dt

Conditions: $T_j=T_{j\ max}$; $I_{TM}=I_{TAV}$; $V_R=100\ V$; $dv_D/dt=50\ V/\mu s$; $V_D=0.67\cdot V_{DRM}$
 Typical changes of t_q are normalized to the t_q^* (t_q^* – see data sheet, $dv_D/dt=50\ V/\mu s$)

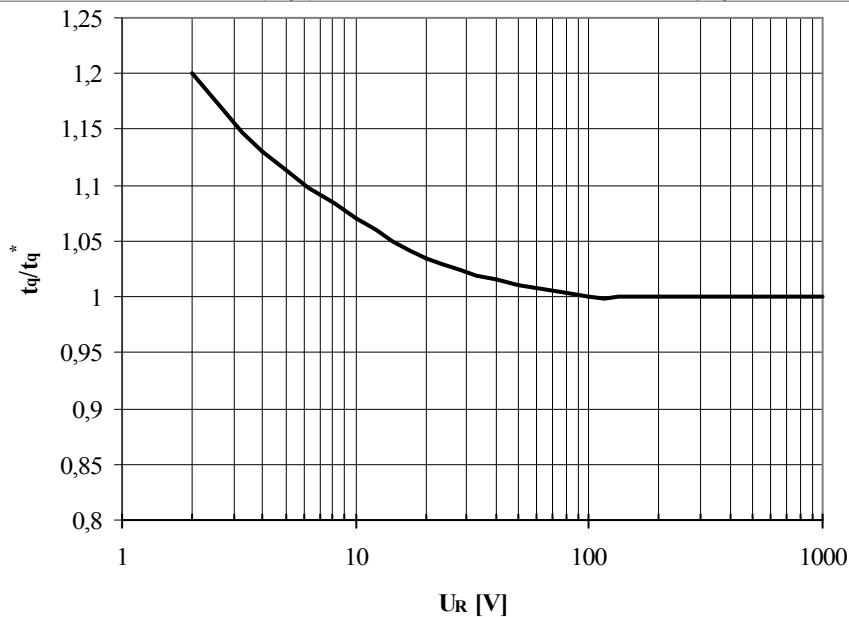

Fig. 5 Turn-off time t_q vs. Reverse voltage V_R

Conditions: $T_j=T_{j\ max}$; $I_{TM}=I_{TAV}$; $di_R/dt=10\ A/\mu s$; $dv_D/dt=50\ V/\mu s$; $V_D=0.67\cdot V_{DRM}$
 Typical changes of t_q are normalized to the t_q^* (t_q^* – see data sheet, $dv_D/dt=50\ V/\mu s$)

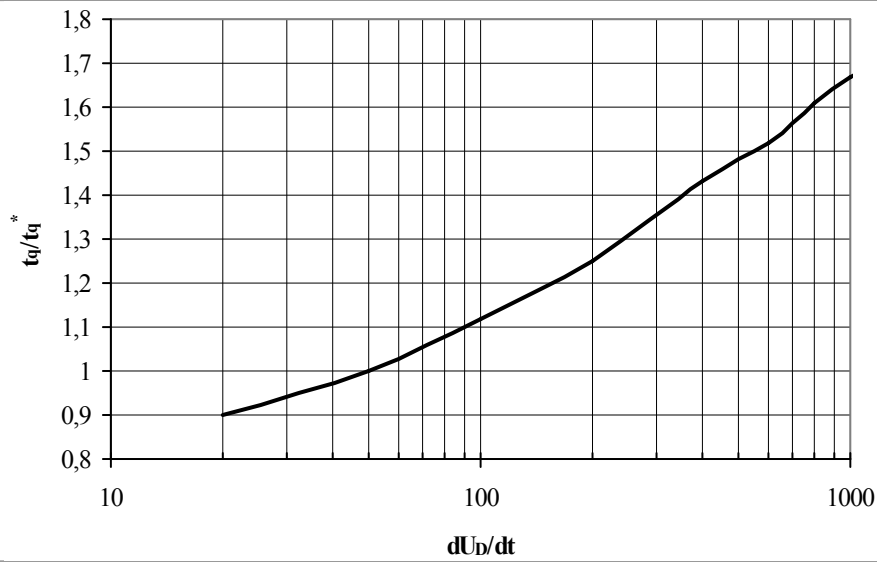

Fig. 6 Turn-off time t_q vs. Rate of rise of commutating voltage dv_D/dt

Conditions: $T_j=T_{j\ max}$; $I_{TM}=I_{TAV}$; $di_R/dt=10\ A/\mu s$; $V_R=100\ V$; $V_D=0.67\cdot V_{DRM}$
 Typical changes of t_q are normalized to the t_q^* (t_q^* – see data sheet, $dv_D/dt=50\ V/\mu s$)

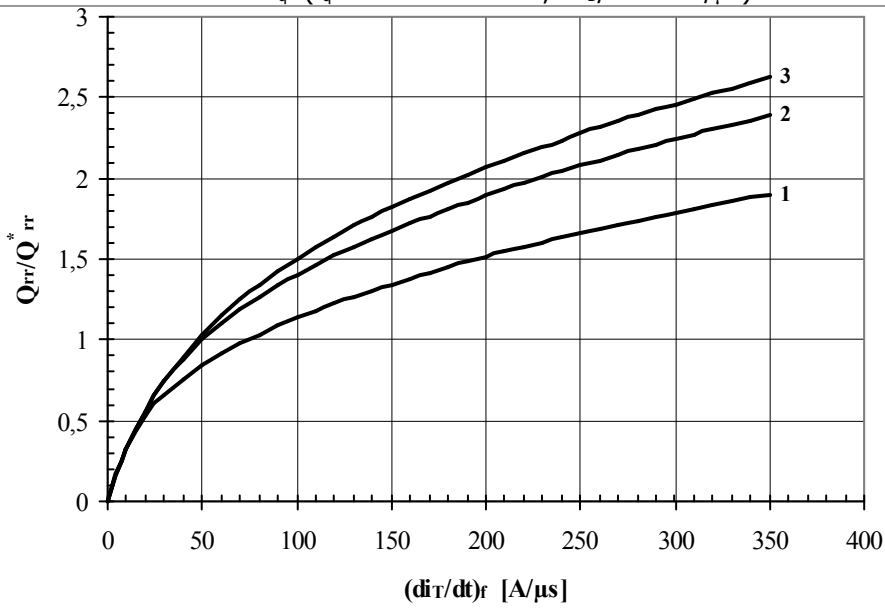

Fig. 7 Reverse recovery charge Q_{rr} vs. Rate of fall of on-state current di_R/dt

- 1 – $I_{TM} = 0.5 \cdot I_{TAV}$
- 2 – $I_{TM} = I_{TAV}$
- 3 – $I_{TM} = 1.5 \cdot I_{TAV}$

Conditions: $T_j=T_{j\ max}$; $V_R=100\ V$
 Typical changes of Q_{rr} are normalized to the Q_{rr}^* (Q_{rr}^* – see data sheet)

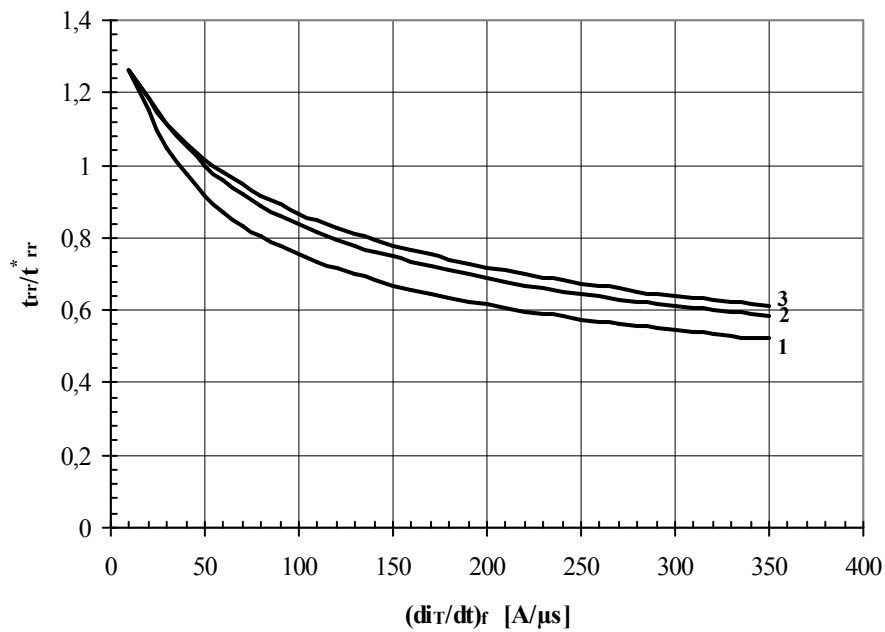

Fig. 8 Reverse recovery time t_{rr} vs. Rate of fall of on-state current di_r/dt

1 - $I_{TM} = 0.5 \cdot I_{TAV}$

2 - $I_{TM} = I_{TAV}$,

3 - $I_{TM} = 1.5 \cdot I_{TAV}$

Conditions: $T_j = T_{j \max}$; $V_R = 100$ V

Typical changes of t_{rr} are normalized to the t_{rr}^* (t_{rr}^* – see data sheet)

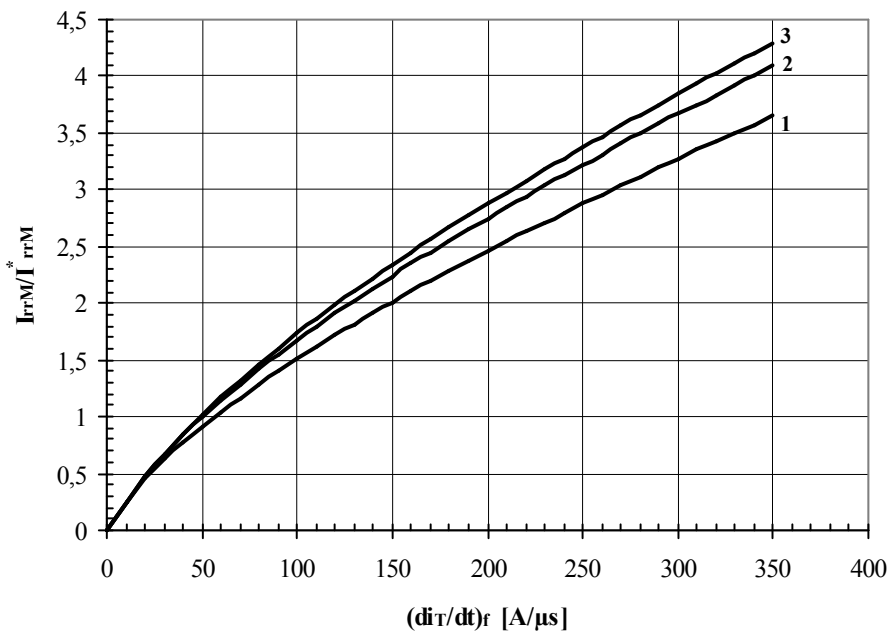

Fig. 9 Peak reverse recovery current I_{rrM} vs. Rate of fall of on-state current di_r/dt

1 - $I_{TM} = 0.5 \cdot I_{TAV}$

2 - $I_{TM} = I_{TAV}$,

3 - $I_{TM} = 1.5 \cdot I_{TAV}$

Conditions: $T_j = T_{j \max}$; $V_R = 100$ V

Typical changes of I_{rrM} are normalized to the I_{rrM}^* (I_{rrM}^* – see data sheet)

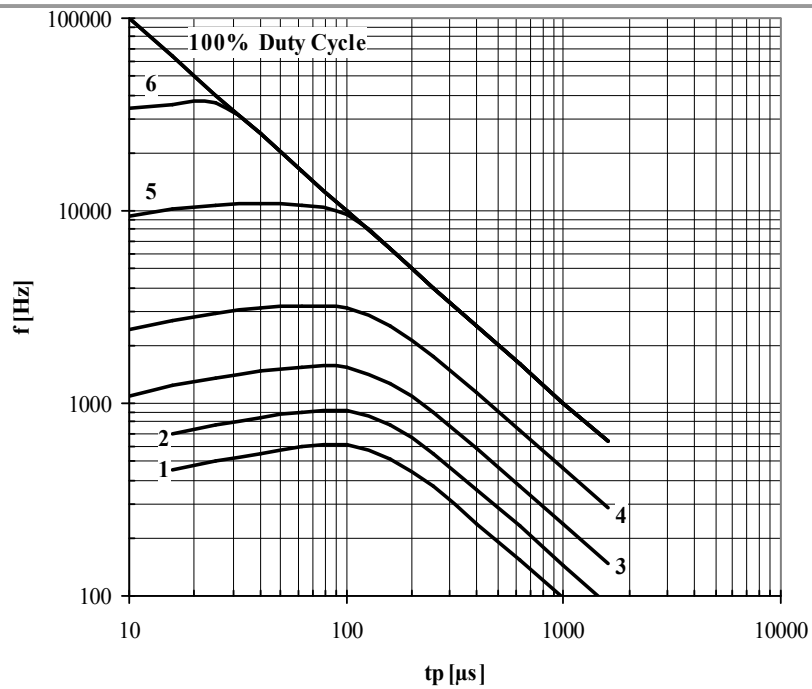

Fig. 10 Sine wave frequency ratings

- 1 - $I_{TM} = 5000$ A
- 2 - $I_{TM} = 4000$ A
- 3 - $I_{TM} = 3000$ A
- 4 - $I_{TM} = 2000$ A
- 5 - $I_{TM} = 1000$ A
- 6 - $I_{TM} = 500$ A

Conditions: $V_R \leq 3$ V; $T_C = 55$ °C

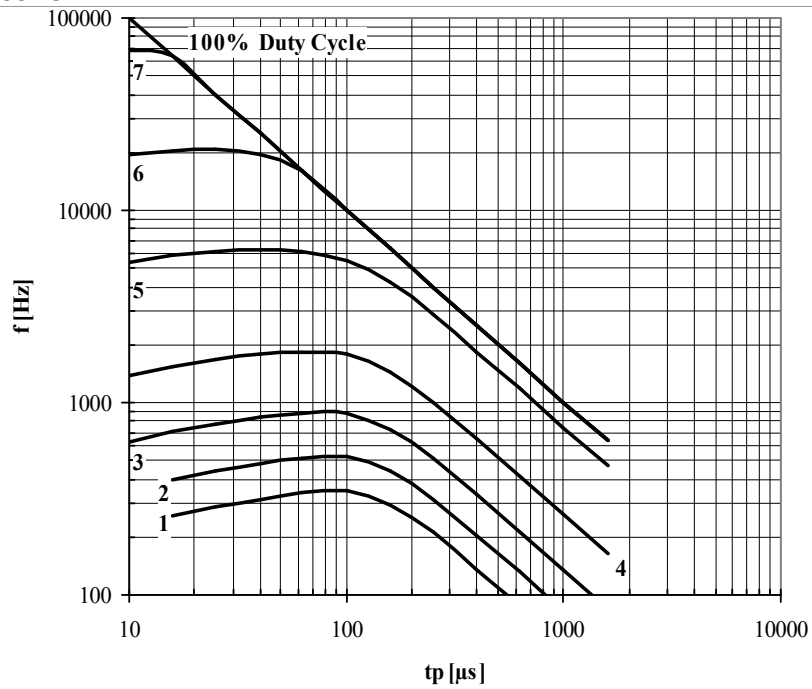

Fig. 11 Sine wave frequency ratings

- 1 - $I_{TM} = 5000$ A
- 2 - $I_{TM} = 4000$ A
- 3 - $I_{TM} = 3000$ A
- 4 - $I_{TM} = 2000$ A
- 5 - $I_{TM} = 1000$ A
- 6 - $I_{TM} = 500$ A
- 7 - $I_{TM} = 250$ A

Conditions: $V_R \leq 3$ V; $T_C = 88$ °C

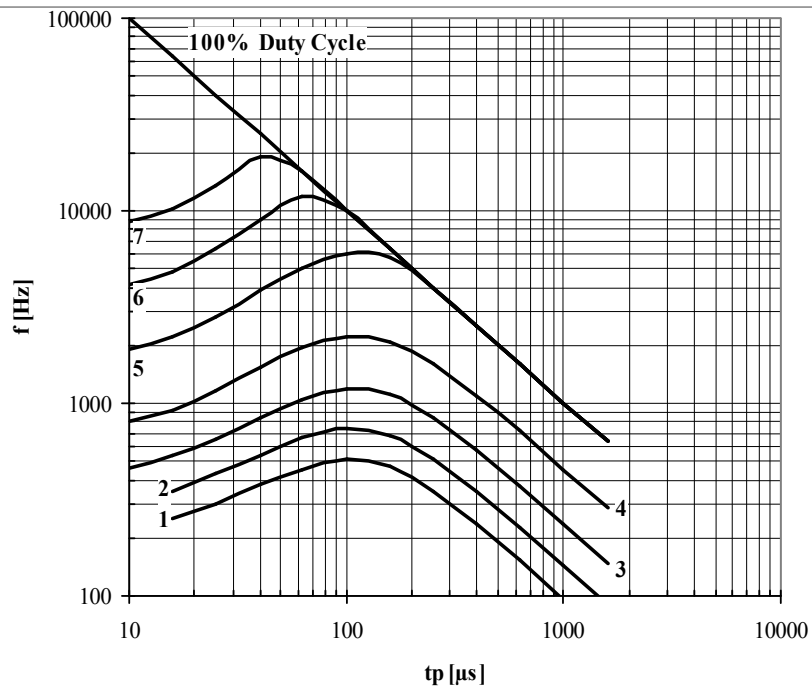

Fig. 12 Sine wave frequency ratings

- 1 - $I_{TM} = 5000$ A
- 2 - $I_{TM} = 4000$ A
- 3 - $I_{TM} = 3000$ A
- 4 - $I_{TM} = 2000$ A
- 5 - $I_{TM} = 1000$ A
- 6 - $I_{TM} = 500$ A
- 7 - $I_{TM} = 250$ A

Conditions: $V_R = 0.67 \cdot V_{RRM}$; $T_C = 55$ °C

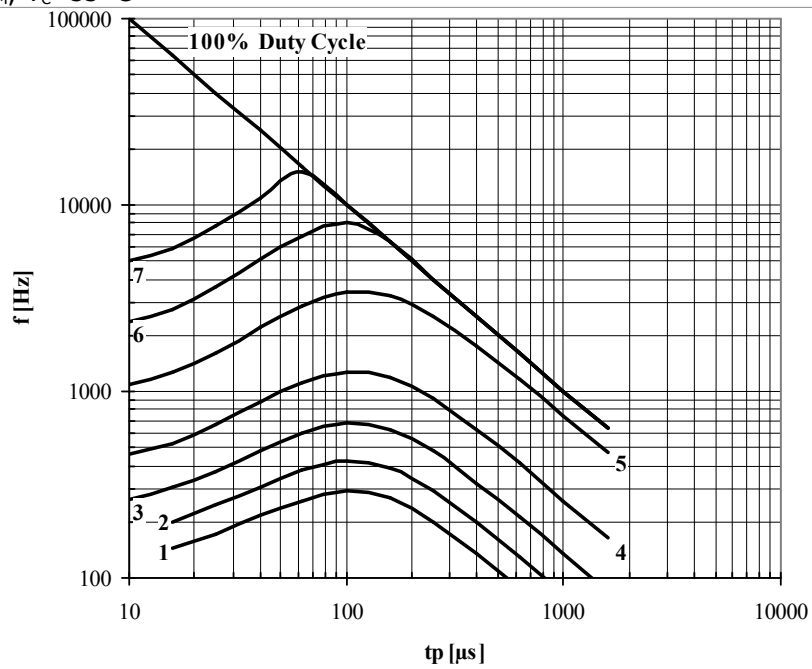

Fig. 13 Sine wave frequency ratings

- 1 - $I_{TM} = 5000$ A
- 2 - $I_{TM} = 4000$ A
- 3 - $I_{TM} = 3000$ A
- 4 - $I_{TM} = 2000$ A
- 5 - $I_{TM} = 1000$ A
- 6 - $I_{TM} = 500$ A
- 7 - $I_{TM} = 250$ A

Conditions: $V_R = 0.67 \cdot V_{RRM}$; $T_C = 88$ °C

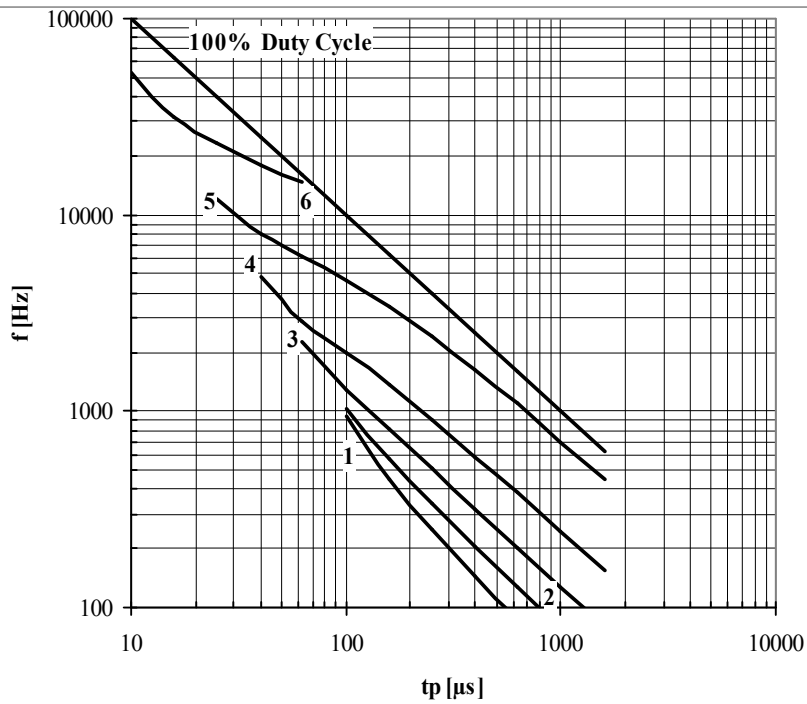

Fig. 14 Square wave frequency ratings

- 1 - $I_{TM} = 5000 \text{ A}$
- 2 - $I_{TM} = 4000 \text{ A}$
- 3 - $I_{TM} = 3000 \text{ A}$
- 4 - $I_{TM} = 2000 \text{ A}$
- 5 - $I_{TM} = 1000 \text{ A}$
- 6 - $I_{TM} = 500 \text{ A}$

Conditions: $V_R \leq 3 \text{ V}$; $T_C = 55 \text{ }^\circ\text{C}$; $di_F/dt = di_R/dt = 100 \text{ A}/\mu\text{s}$

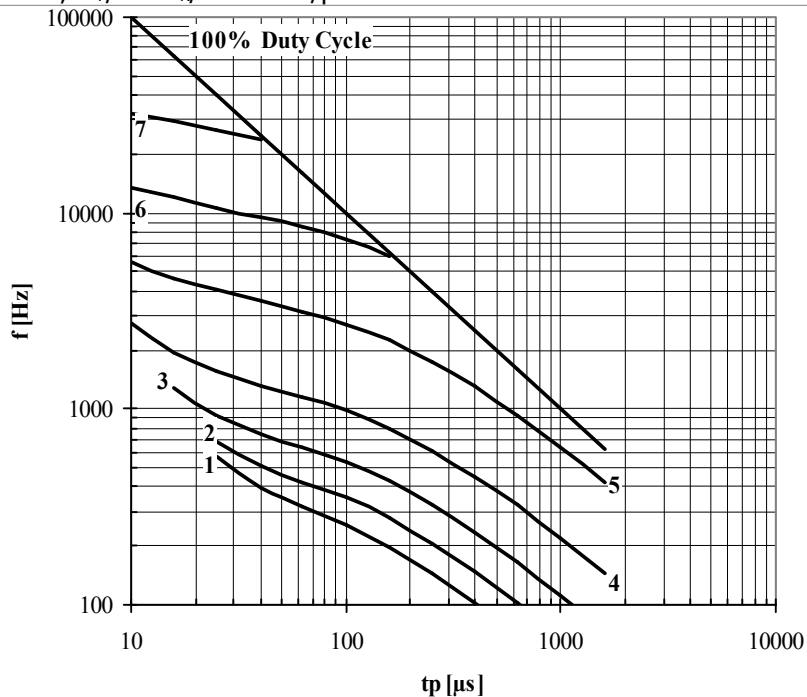

Fig. 15 Square wave frequency ratings

- 1 - $I_{TM} = 5000 \text{ A}$
- 2 - $I_{TM} = 4000 \text{ A}$
- 3 - $I_{TM} = 3000 \text{ A}$
- 4 - $I_{TM} = 2000 \text{ A}$
- 5 - $I_{TM} = 1000 \text{ A}$
- 6 - $I_{TM} = 500 \text{ A}$
- 7 - $I_{TM} = 250 \text{ A}$

Conditions: $V_R \leq 3 \text{ V}$; $T_C = 55 \text{ }^\circ\text{C}$; $di_F/dt = di_R/dt = 500 \text{ A}/\mu\text{s}$

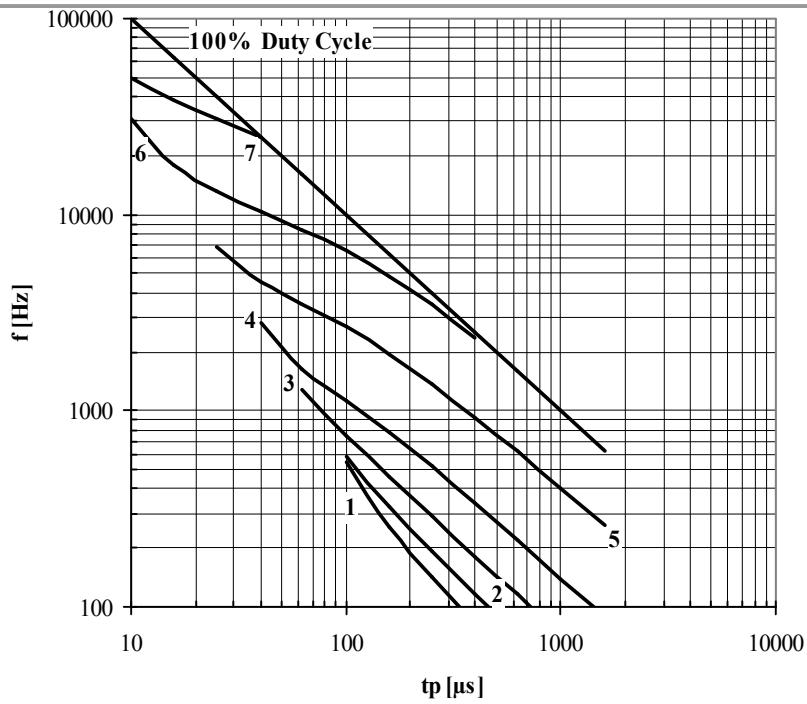

Fig. 16 Square wave frequency ratings

- 1 - $I_{TM} = 5000 \text{ A}$
- 2 - $I_{TM} = 4000 \text{ A}$
- 3 - $I_{TM} = 3000 \text{ A}$
- 4 - $I_{TM} = 2000 \text{ A}$
- 5 - $I_{TM} = 1000 \text{ A}$
- 6 - $I_{TM} = 500 \text{ A}$
- 7 - $I_{TM} = 250 \text{ A}$

Conditions: $V_R \leq 3 \text{ V}$; $T_C = 88 \text{ }^\circ\text{C}$; $di_F/dt = di_R/dt = 100 \text{ A}/\mu\text{s}$

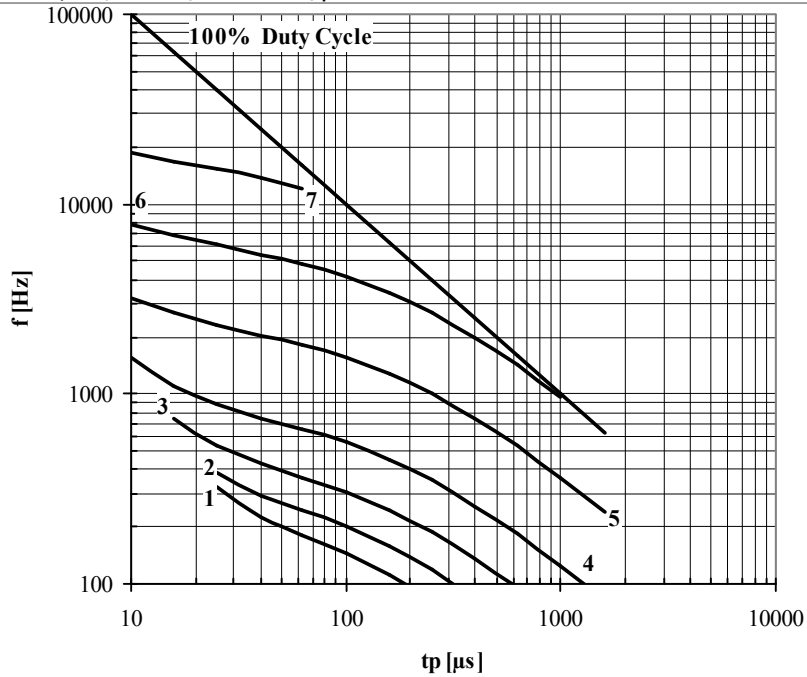

Fig. 17 Square wave frequency ratings

- 1 - $I_{TM} = 5000 \text{ A}$
- 2 - $I_{TM} = 4000 \text{ A}$
- 3 - $I_{TM} = 3000 \text{ A}$
- 4 - $I_{TM} = 2000 \text{ A}$
- 5 - $I_{TM} = 1000 \text{ A}$
- 6 - $I_{TM} = 500 \text{ A}$
- 7 - $I_{TM} = 250 \text{ A}$

Conditions: $V_R \leq 3 \text{ V}$; $T_C = 88 \text{ }^\circ\text{C}$; $di_F/dt = di_R/dt = 500 \text{ A}/\mu\text{s}$

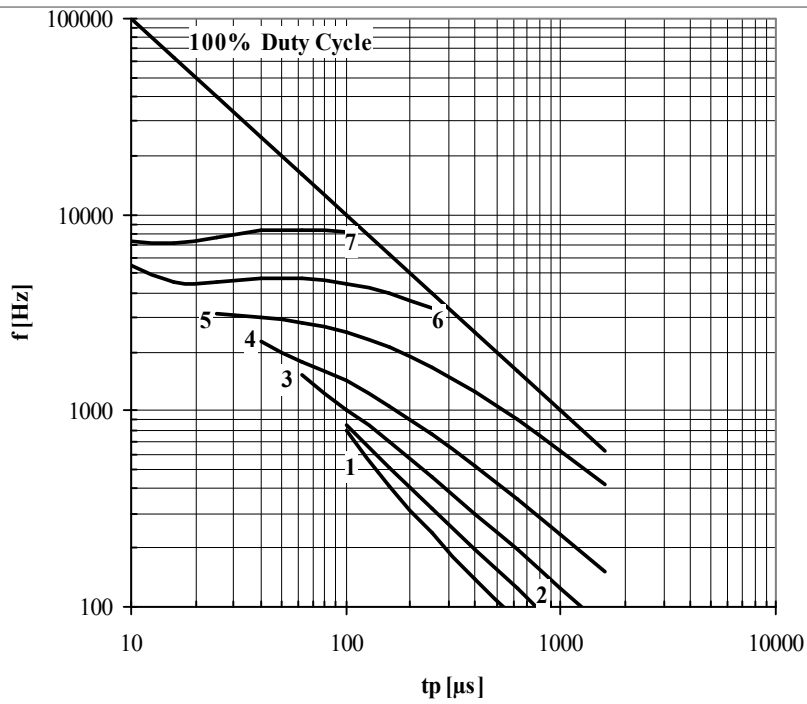

Fig. 18 Square wave frequency ratings

- 1 - $I_{TM} = 5000 \text{ A}$
- 2 - $I_{TM} = 4000 \text{ A}$
- 3 - $I_{TM} = 3000 \text{ A}$
- 4 - $I_{TM} = 2000 \text{ A}$
- 5 - $I_{TM} = 1000 \text{ A}$
- 6 - $I_{TM} = 500 \text{ A}$
- 7 - $I_{TM} = 250 \text{ A}$

Conditions: $V_R = 0.67 \cdot V_{RRM}$; $T_C = 55 \text{ }^\circ\text{C}$; $di_F/dt = di_R/dt = 100 \text{ A}/\mu\text{s}$

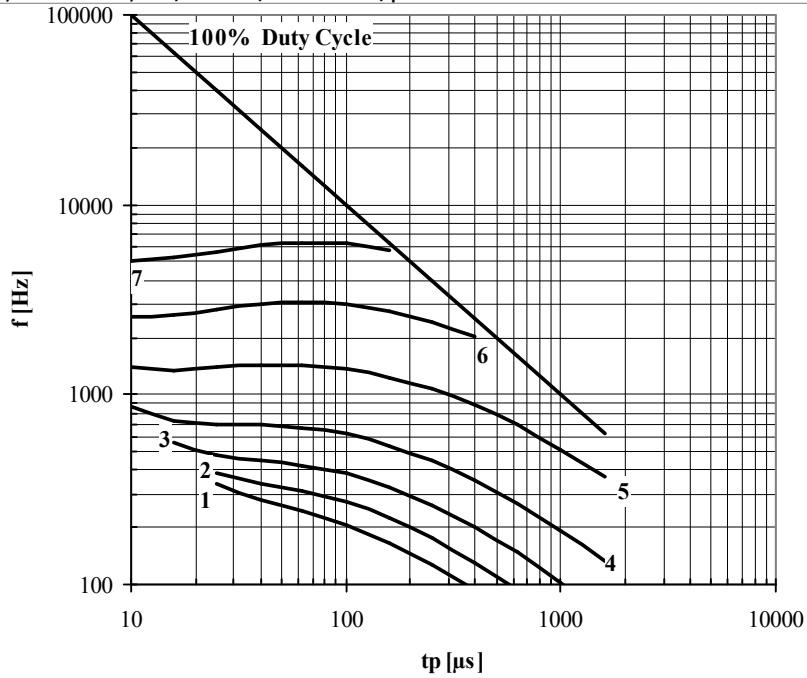

Fig. 19 Square wave frequency ratings

- 1 - $I_{TM} = 5000 \text{ A}$
- 2 - $I_{TM} = 4000 \text{ A}$
- 3 - $I_{TM} = 3000 \text{ A}$
- 4 - $I_{TM} = 2000 \text{ A}$
- 5 - $I_{TM} = 1000 \text{ A}$
- 6 - $I_{TM} = 500 \text{ A}$
- 7 - $I_{TM} = 250 \text{ A}$

Conditions: $V_R = 0.67 \cdot V_{RRM}$; $T_C = 55 \text{ }^\circ\text{C}$; $di_F/dt = di_R/dt = 500 \text{ A}/\mu\text{s}$

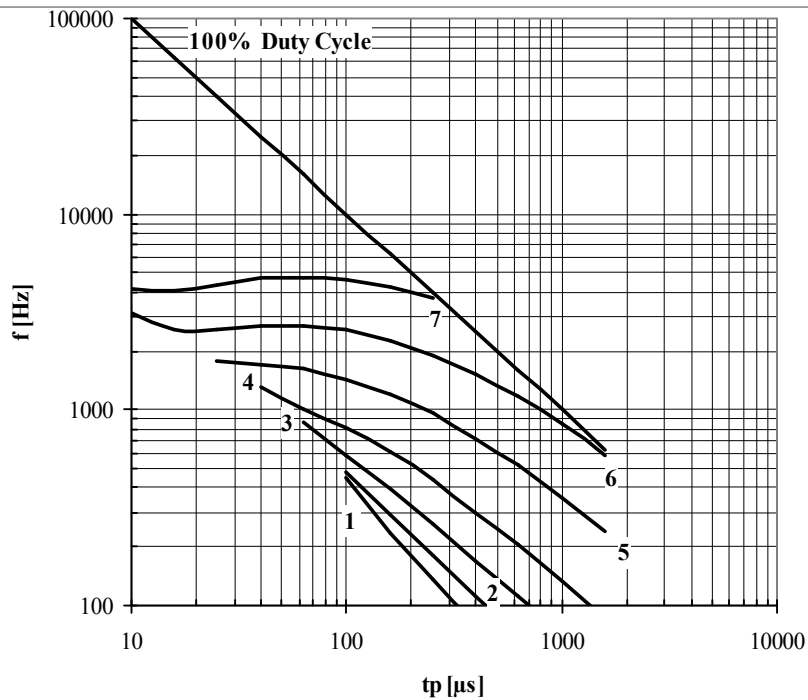

Fig. 20 Square wave frequency ratings

- 1 - $I_{TM} = 5000 \text{ A}$
- 2 - $I_{TM} = 4000 \text{ A}$
- 3 - $I_{TM} = 3000 \text{ A}$
- 4 - $I_{TM} = 2000 \text{ A}$
- 5 - $I_{TM} = 1000 \text{ A}$
- 6 - $I_{TM} = 500 \text{ A}$
- 7 - $I_{TM} = 250 \text{ A}$

Conditions: $V_R = 0.67 \cdot V_{RRM}$; $T_C = 88 \text{ }^\circ\text{C}$; $di_F/dt = di_R/dt = 100 \text{ A}/\mu\text{s}$

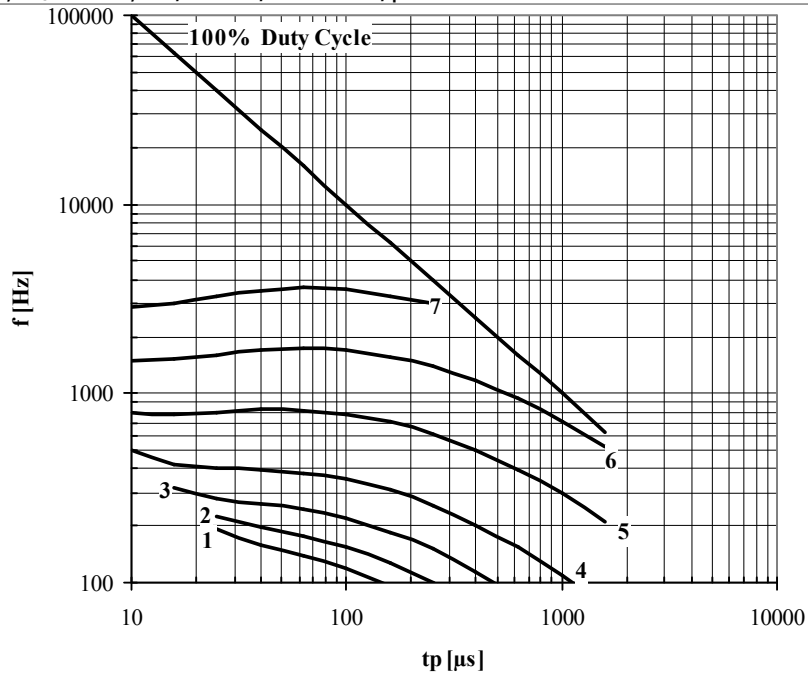

Fig. 21 Square wave frequency ratings

- 1 - $I_{TM} = 5000 \text{ A}$
- 2 - $I_{TM} = 4000 \text{ A}$
- 3 - $I_{TM} = 3000 \text{ A}$
- 4 - $I_{TM} = 2000 \text{ A}$
- 5 - $I_{TM} = 1000 \text{ A}$
- 6 - $I_{TM} = 500 \text{ A}$
- 7 - $I_{TM} = 250 \text{ A}$

Conditions: $V_R = 0.67 \cdot V_{RRM}$; $T_C = 88 \text{ }^\circ\text{C}$; $di_F/dt = di_R/dt = 500 \text{ A}/\mu\text{s}$

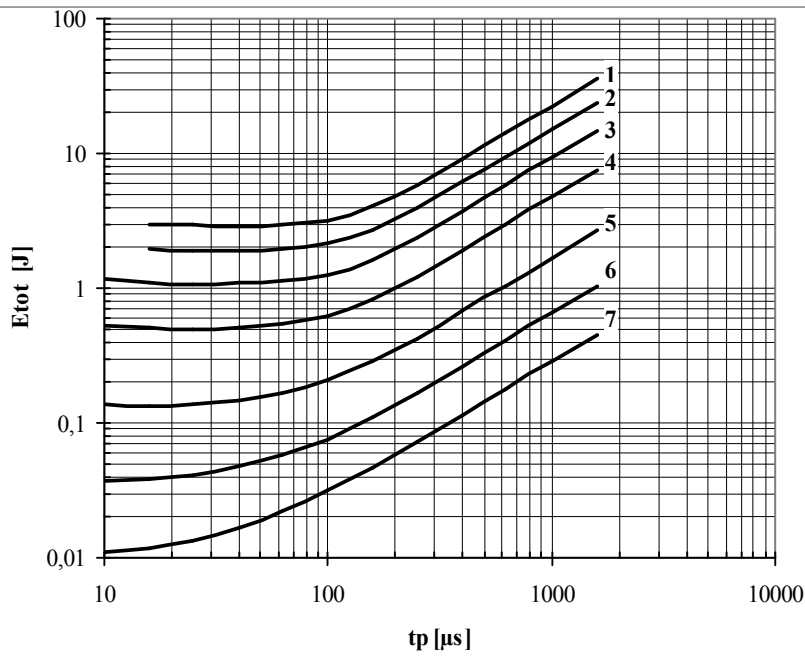

Fig. 22 Sine wave loss energy per pulse

- 1 - $I_{TM} = 5000$ A
- 2 - $I_{TM} = 4000$ A
- 3 - $I_{TM} = 3000$ A
- 4 - $I_{TM} = 2000$ A
- 5 - $I_{TM} = 1000$ A
- 6 - $I_{TM} = 500$ A
- 7 - $I_{TM} = 250$ A

Conditions: $V_R \leq 3$ V

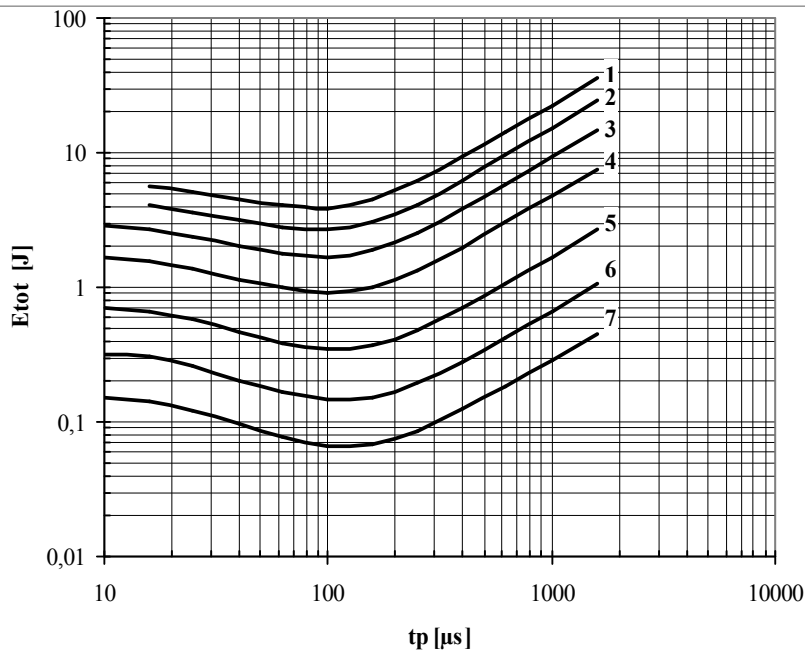

Fig. 23 Sine wave loss energy per pulse

- 1 - $I_{TM} = 5000$ A
- 2 - $I_{TM} = 4000$ A
- 3 - $I_{TM} = 3000$ A
- 4 - $I_{TM} = 2000$ A
- 5 - $I_{TM} = 1000$ A
- 6 - $I_{TM} = 500$ A
- 7 - $I_{TM} = 250$ A

Conditions: $V_R = 0.67 \cdot V_{RRM}$

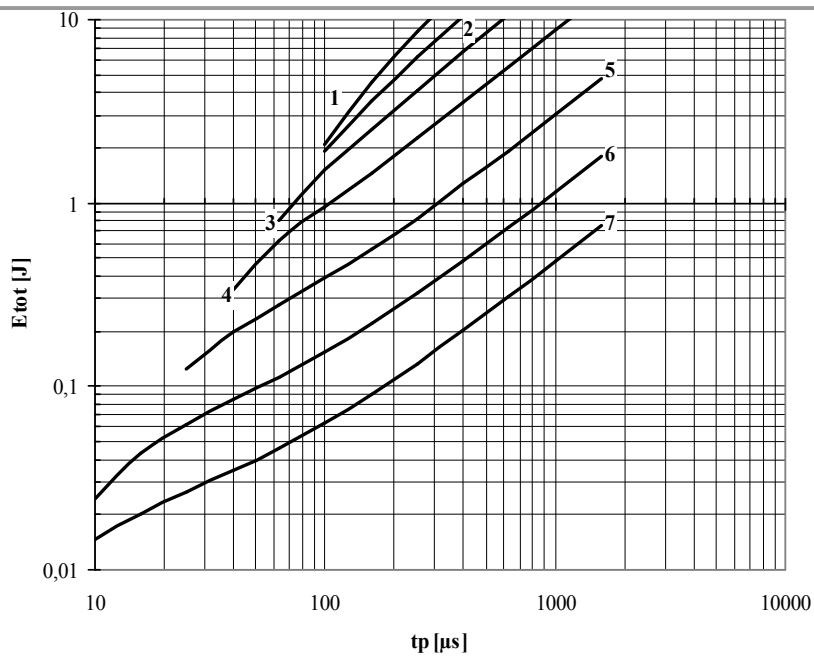

Fig. 24 Square wave loss energy per pulse

- 1 - $I_{TM} = 5000$ A
- 2 - $I_{TM} = 4000$ A
- 3 - $I_{TM} = 3000$ A
- 4 - $I_{TM} = 2000$ A
- 5 - $I_{TM} = 1000$ A
- 6 - $I_{TM} = 500$ A
- 7 - $I_{TM} = 250$ A

Conditions: $V_R \leq 3$ V; $di_F/dt = di_R/dt = 100$ A/ μ s

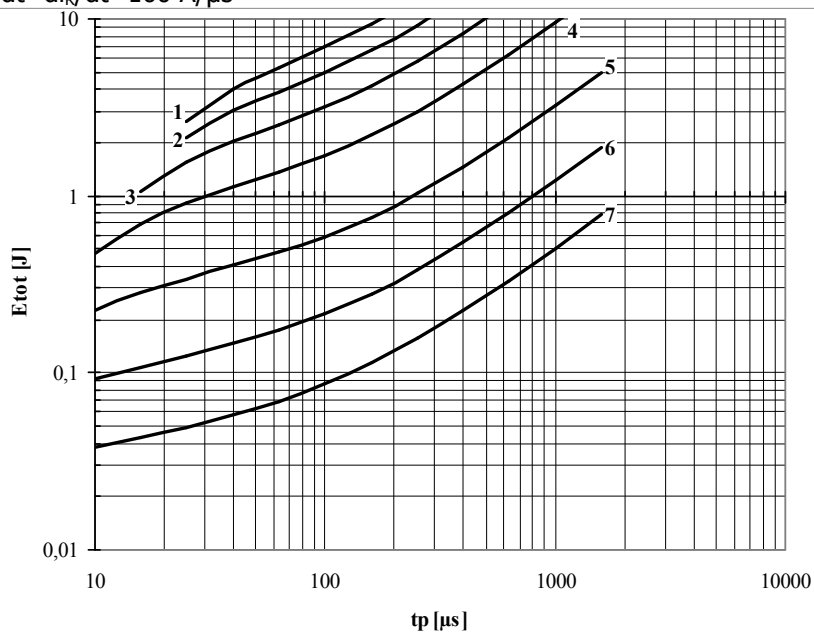

Fig. 25 Square wave loss energy per pulse

- 1 - $I_{TM} = 5000$ A
- 2 - $I_{TM} = 4000$ A
- 3 - $I_{TM} = 3000$ A
- 4 - $I_{TM} = 2000$ A
- 5 - $I_{TM} = 1000$ A
- 6 - $I_{TM} = 500$ A
- 7 - $I_{TM} = 250$ A

Conditions: $V_R \leq 3$ V; $di_F/dt = di_R/dt = 500$ A/ μ s

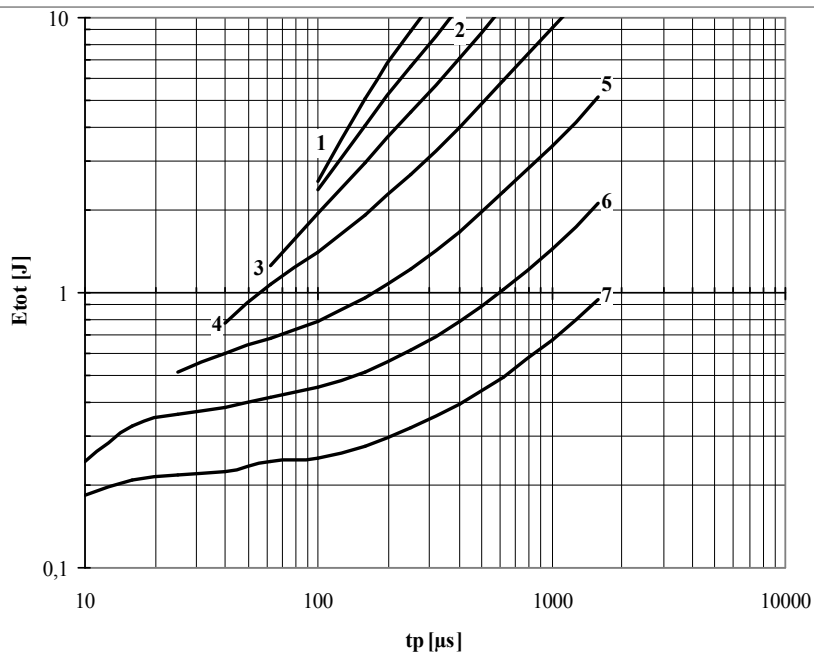

Fig. 26 Square wave loss energy per pulse

- 1 - $I_{TM} = 5000$ A
- 2 - $I_{TM} = 4000$ A
- 3 - $I_{TM} = 3000$ A
- 4 - $I_{TM} = 2000$ A
- 5 - $I_{TM} = 1000$ A
- 6 - $I_{TM} = 500$ A
- 7 - $I_{TM} = 250$ A

Conditions: $V_R = 0.67 \cdot V_{RRM}$; $di_F/dt = di_R/dt = 100$ A/ μ s

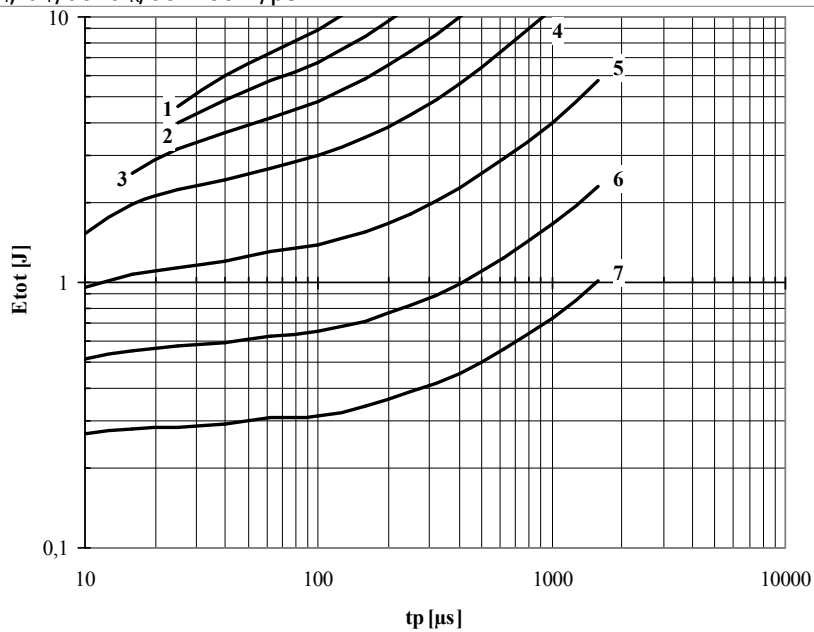

Fig. 27 Square wave loss energy per pulse

- 1 - $I_{TM} = 5000$ A
- 2 - $I_{TM} = 4000$ A
- 3 - $I_{TM} = 3000$ A
- 4 - $I_{TM} = 2000$ A
- 5 - $I_{TM} = 1000$ A
- 6 - $I_{TM} = 500$ A
- 7 - $I_{TM} = 250$ A

Conditions: $V_R = 0.67 \cdot V_{RRM}$; $di_F/dt = di_R/dt = 500$ A/ μ s

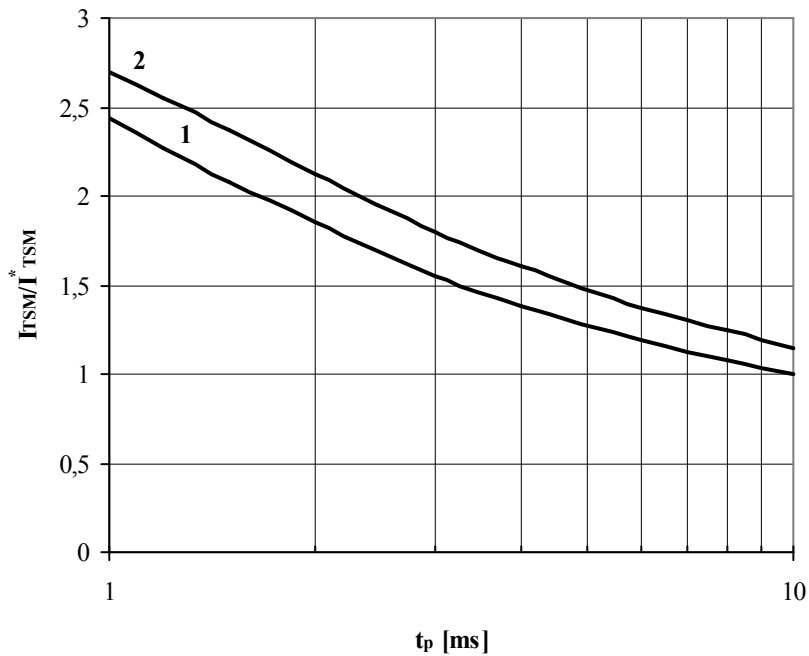

Fig. 28 The surge current I_{TSM} vs. Duration of surge t_p for a half-sine wave
 1 – $T_j=125\text{ °C}$
 2 – $T_j=25\text{ °C}$

Conditions: $V_R=0\text{ V}$ – the peak value of reverse voltage which is applied immediately after the surge current
 Typical changes of I_{TSM} are normalized to the I_{TSM}^* (I_{TSM}^* – see data sheet, $T_j=T_{j\text{ max}}$)

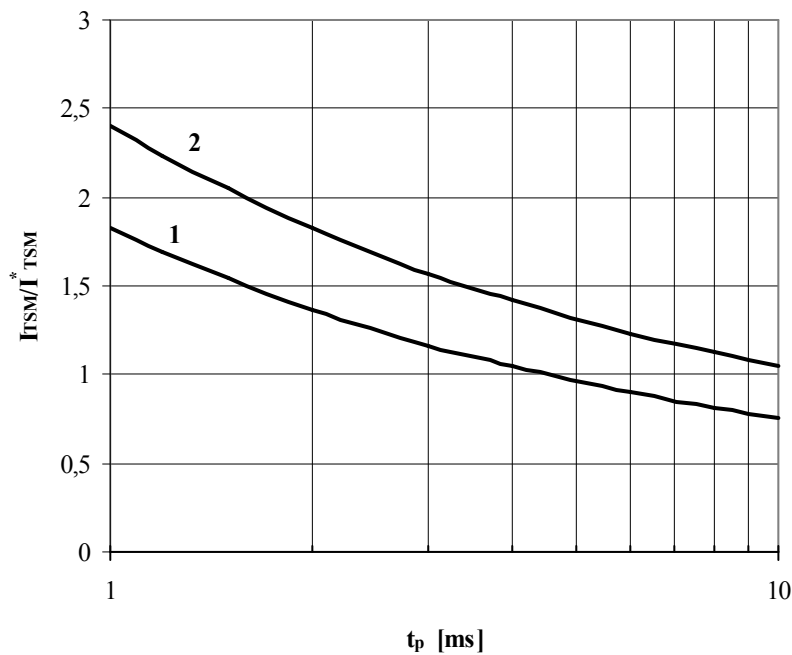

Fig. 29 The surge current I_{TSM} vs. Duration of surge t_p for a half-sine wave
 1 – $T_j=125\text{ °C}$
 2 – $T_j=25\text{ °C}$

Conditions: $V_R=0.8\cdot V_{RRM}$ – the peak value of reverse voltage which is applied immediately after the surge current
 Typical changes of I_{TSM} are normalized to the I_{TSM}^* (I_{TSM}^* – see data sheet, $T_j=T_{j\text{ max}}$)

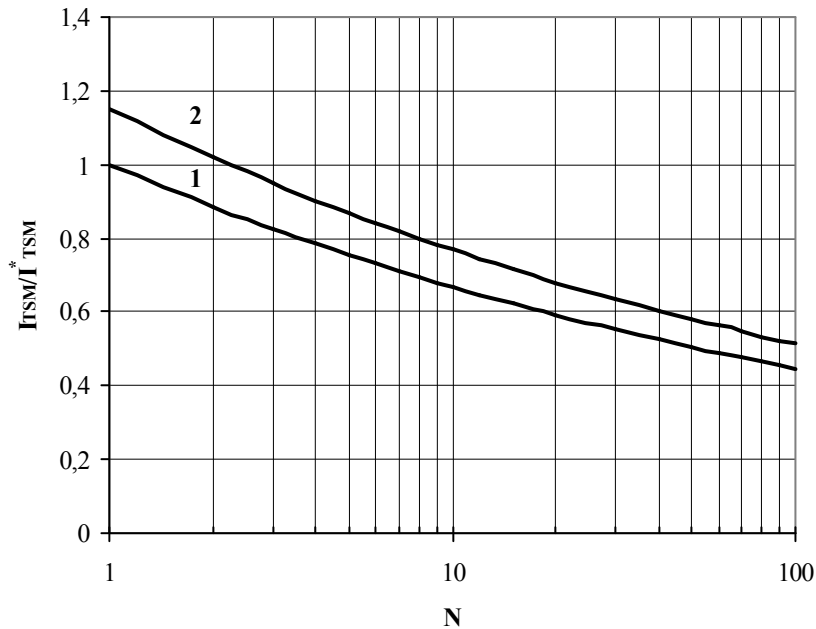

Fig. 30 The surge current I_{TSM} vs. Number of half-sine waves at 50 Hz
 1 – $T_j=125\text{ }^\circ\text{C}$
 2 – $T_j=25\text{ }^\circ\text{C}$

Conditions: $V_R=0\text{ V}$ – the peak value of reverse voltage which is applied immediately after the surge current
 Typical changes of I_{TSM} are normalized to the I_{TSM}^* (I_{TSM}^* – see data sheet, $T_j=T_{j\text{max}}$)

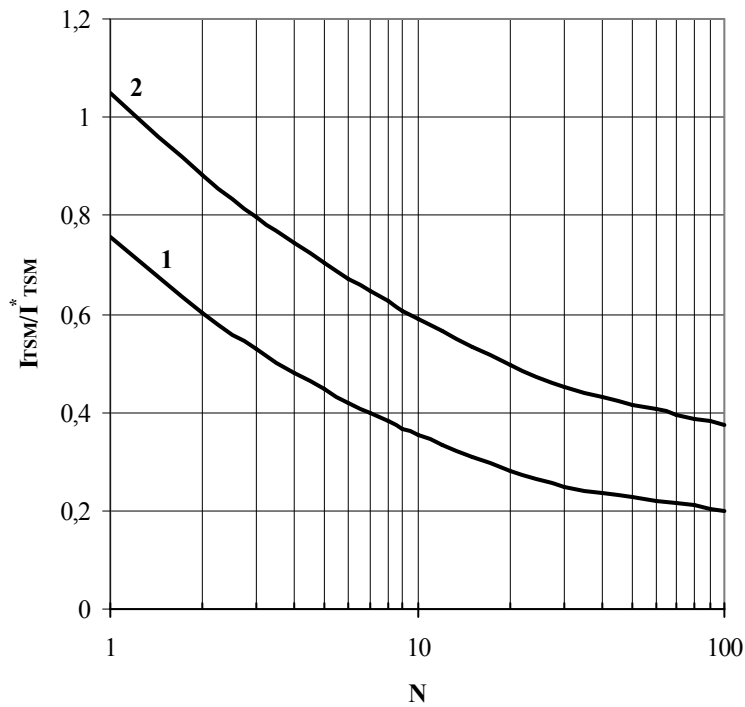

Fig. 31 The surge current I_{TSM} vs. Number of half-sine waves at 50 Hz
 1 – $T_j=125^\circ\text{C}$
 2 – $T_j=25^\circ\text{C}$

Conditions: $V_R=0.8 \cdot V_{RRM}$ – the peak value of reverse voltage which is applied immediately after the surge current
 Typical changes of I_{TSM} are normalized to the I_{TSM}^* (I_{TSM}^* – see data sheet, $T_j=T_{j\text{max}}$)