



**Fast Thyristor  
Type TFI143-630-15**

Low switching losses  
Low reverse recovery charge  
Distributed amplified gate for high  $di_T/dt$

Mean on-state current	$I_{TAV}$			630 A		
Repetitive peak off-state voltage	$V_{DRM}$			1000...1500 V		
Repetitive peak reverse voltage	$V_{RRM}$					
Turn-off time	$t_q$			16.0, 20.0, 25.0, 32.0 $\mu s$		
$V_{DRM}, V_{RRM}, V$	1000	1100	1200	1300	1400	1500
Voltage code	10	11	12	13	14	15
$T_j, ^\circ C$	-60...+125					

**MAXIMUM ALLOWABLE RATINGS**

Symbols and parameters		Units	Values	Test conditions	
<b>ON-STATE</b>					
$I_{TAV}$	Mean on-state current	A	590 630 882	$T_c = 85^\circ C$ ; Double side cooled; $T_c = 81^\circ C$ ; Double side cooled; $T_c = 55^\circ C$ ; Double side cooled; 180° half-sine wave; 50 Hz	
$I_{TRMS}$	RMS on-state current	A	989	$T_c = 81^\circ C$ ; Double side cooled; 180° half-sine wave; 50 Hz	
$I_{TSM}$	Surge on-state current	kA	11.5 13.0	$T_j = T_{jmax}$ $T_j = 25^\circ C$	180° half-sine wave; $t_p = 10$ ms; single pulse; $V_D = V_R = 0$ V; Gate pulse: $I_G = I_{FGM}$ ; $V_G = 20$ V; $t_{GP} = 50$ $\mu s$ ; $di_G/dt = 1$ A/ $\mu s$
			12.0 14.0	$T_j = T_{jmax}$ $T_j = 25^\circ C$	180° half-sine wave; $t_p = 8.3$ ms; single pulse; $V_D = V_R = 0$ V; Gate pulse: $I_G = I_{FGM}$ ; $V_G = 20$ V; $t_{GP} = 50$ $\mu s$ ; $di_G/dt = 1$ A/ $\mu s$
$I^2t$	Safety factor	$A^2s \cdot 10^3$	660 840	$T_j = T_{jmax}$ $T_j = 25^\circ C$	180° half-sine wave; $t_p = 10$ ms; single pulse; $V_D = V_R = 0$ V; Gate pulse: $I_G = I_{FGM}$ ; $V_G = 20$ V; $t_{GP} = 50$ $\mu s$ ; $di_G/dt = 1$ A/ $\mu s$
			590 810	$T_j = T_{jmax}$ $T_j = 25^\circ C$	180° half-sine wave; $t_p = 8.3$ ms; single pulse; $V_D = V_R = 0$ V; Gate pulse: $I_G = I_{FGM}$ ; $V_G = 20$ V; $t_{GP} = 50$ $\mu s$ ; $di_G/dt = 1$ A/ $\mu s$
<b>BLOCKING</b>					
$V_{DRM}, V_{RRM}$	Repetitive peak off-state and Repetitive peak reverse voltages	V	1000...1500	$T_{jmin} < T_j < T_{jmax}$ ; 180° half-sine wave; 50 Hz; Gate open	
$V_{DSM}, V_{RSM}$	Non-repetitive peak off-state and Non-repetitive peak reverse voltages	V	1100...1600	$T_{jmin} < T_j < T_{jmax}$ ; 180° half-sine wave; single pulse; Gate open	
$V_D, V_R$	Direct off-state and Direct reverse voltages	V	$0.6 \cdot V_{DRM}$ $0.6 \cdot V_{RRM}$	$T_j = T_{jmax}$ ; Gate open	

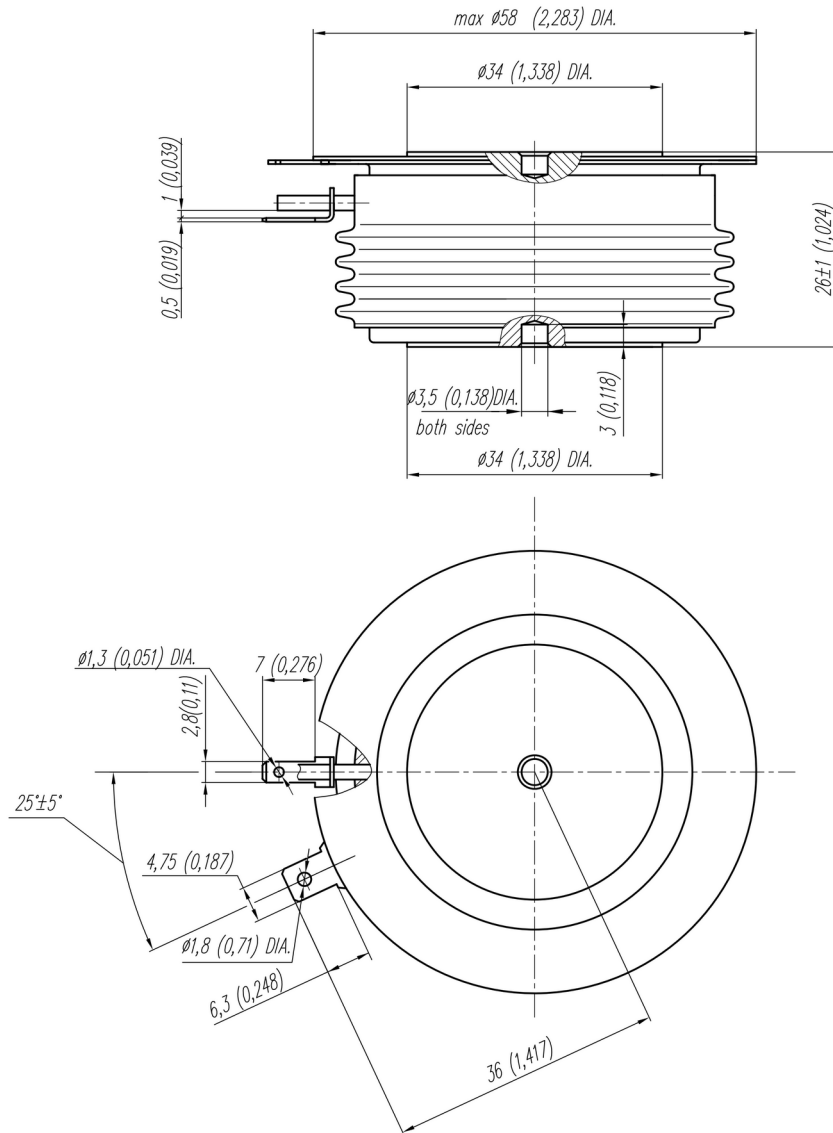
<b>TRIGGERING</b>				
$I_{FGM}$	Peak forward gate current	A	8	$T_j = T_{j\ max}$
$V_{RGM}$	Peak reverse gate voltage	V	5	
$P_G$	Gate power dissipation	W	8	$T_j = T_{j\ max}$ for DC gate current
<b>SWITCHING</b>				
$(di_T/dt)_{crit}$	Critical rate of rise of on-state current non-repetitive (f=1 Hz)	A/ $\mu$ s	2000	$T_j = T_{j\ max}$ ; $V_D = 0.67 \cdot V_{DRM}$ ; $I_{TM} = 4600$ A; Gate pulse: $I_G = 2$ A; $V_G = 20$ V; $t_{GP} = 50$ $\mu$ s; $di_G/dt = 2$ A/ $\mu$ s
<b>THERMAL</b>				
$T_{stg}$	Storage temperature	$^{\circ}$ C	-60...+50	
$T_j$	Operating junction temperature	$^{\circ}$ C	-60...+125	
<b>MECHANICAL</b>				
F	Mounting force	kN	14.0...16.0	
a	Acceleration	m/s <sup>2</sup>	50	Device clamped

## CHARACTERISTICS

Symbols and parameters		Units	Values	Conditions	
<b>ON-STATE</b>					
$V_{TM}$	Peak on-state voltage, max	V	2.30	$T_j = 25$ $^{\circ}$ C; $I_{TM} = 1978$ A	
$V_{T(TO)}$	On-state threshold voltage, max	V	1.394	$T_j = T_{j\ max}$ ;	
$r_T$	On-state slope resistance, max	m $\Omega$	0.501	$0.5 \pi I_{TAV} < I_T < 1.5 \pi I_{TAV}$	
$I_H$	Holding current, max	mA	500	$T_j = 25$ $^{\circ}$ C; $V_D = 12$ V; Gate open	
<b>BLOCKING</b>					
$I_{DRM}, I_{RRM}$	Repetitive peak off-state and Repetitive peak reverse currents, max	mA	100	$T_j = T_{j\ max}$ ; $V_D = V_{DRM}$ ; $V_R = V_{RRM}$	
$(dv_D/dt)_{crit}$	Critical rate of rise of off-state voltage <sup>1)</sup> , min	V/ $\mu$ s	200, 320, 500, 1000, 1600, 2000, 2500	$T_j = T_{j\ max}$ ; $V_D = 0.67 \cdot V_{DRM}$ ; Gate open	
<b>TRIGGERING</b>					
$V_{GT}$	Gate trigger direct voltage, max	V	3.00 2.50 1.50	$T_j = T_{j\ min}$ $T_j = 25$ $^{\circ}$ C $T_j = T_{j\ max}$	$V_D = 12$ V; $I_D = 3$ A; Direct gate current
$I_{GT}$	Gate trigger direct current, max	mA	500 300 150	$T_j = T_{j\ min}$ $T_j = 25$ $^{\circ}$ C $T_j = T_{j\ max}$	
$V_{GD}$	Gate non-trigger direct voltage, min	V	0.40	$T_j = T_{j\ max}$ ; $V_D = 0.67 \cdot V_{DRM}$ ;	
$I_{GD}$	Gate non-trigger direct current, min	mA	45.00	Direct gate current	
<b>SWITCHING</b>					
$t_{gd}$	Delay time, max	$\mu$ s	0.85	$T_j = 25$ $^{\circ}$ C; $V_D = 600$ V; $I_{TM} = I_{TAV}$ ; $di/dt = 200$ A/ $\mu$ s;	
$t_{gt}$	Turn-on time <sup>2)</sup> , max	$\mu$ s	1.60, 2.00, 2.50, 3.20	Gate pulse: $I_G = 2$ A; $V_G = 20$ V; $t_{GP} = 50$ $\mu$ s; $di_G/dt = 2$ A/ $\mu$ s	
$t_q$	Turn-off time <sup>3)</sup> max	$\mu$ s	16.0, 20.0, 25.0, 32.0	$dv_D/dt = 50$ V/ $\mu$ s;	$T_j = T_{j\ max}$ ; $I_{TM} = I_{TAV}$ ; $di_R/dt = -10$ A/ $\mu$ s; $V_R = 100$ V; $V_D = 0.67 \cdot V_{DRM}$
			20.0, 25.0, 32.0, 40.0	$dv_D/dt = 200$ V/ $\mu$ s;	
$Q_{rr}$	Total recovered charge, max	$\mu$ C	250	$T_j = T_{j\ max}$ ; $I_{TM} = 630$ A;	
$t_{rr}$	Reverse recovery time, typ	$\mu$ s	4.0	$di_R/dt = -50$ A/ $\mu$ s;	
$I_{rrM}$	Peak reverse recovery current, max	A	130	$V_R = 100$ V	

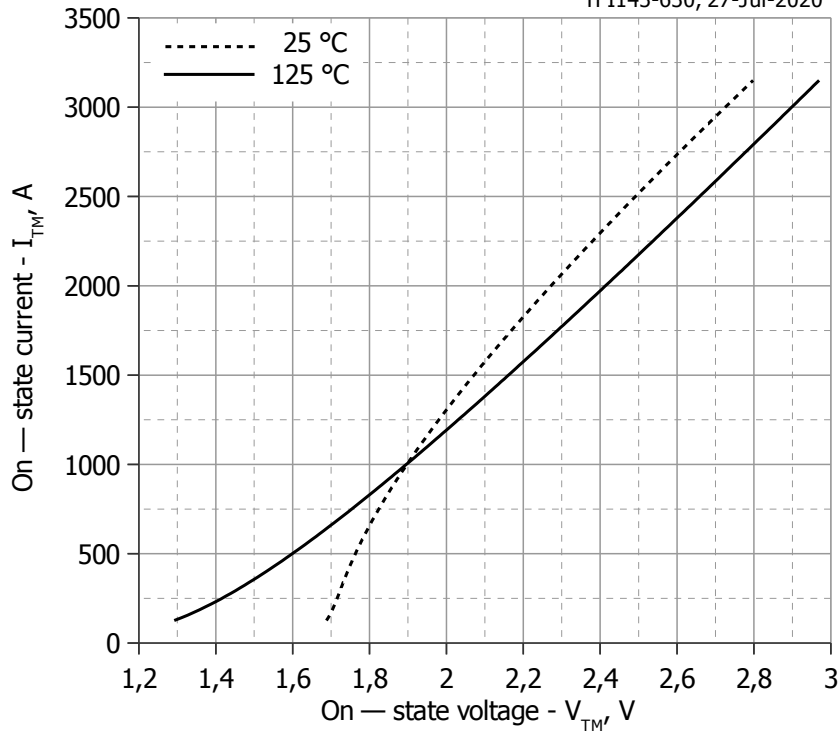
THERMAL					
$R_{thjc}$	Thermal resistance, junction to case, max	°C/W	0.0320	Direct current	Double side cooled
$R_{thjc-A}$			0.0704		Anode side cooled
$R_{thjc-K}$			0.0576		Cathode side cooled
$R_{thck}$	Thermal resistance, case to heatsink, max	°C/W	0.0060	Direct current	
MECHANICAL					
w	Weight, max	g	280		
$D_s$	Surface creepage distance	mm (inch)	27.60 (1.087)		
$D_a$	Air strike distance	mm (inch)	16.00 (0.630)		

PART NUMBERING GUIDE								NOTES																																											
TFI	143	630	15	A2	K3	K4	N	<sup>1)</sup> Critical rate of rise of off-state voltage <table border="1"> <thead> <tr> <th>Symbol of Group</th> <th>P2</th> <th>K2</th> <th>E2</th> <th>A2</th> <th>T1</th> <th>P1</th> <th>M1</th> </tr> </thead> <tbody> <tr> <td><math>(dv_D/dt)_{crit}</math>, V/<math>\mu</math>s</td> <td>200</td> <td>320</td> <td>500</td> <td>1000</td> <td>1600</td> <td>2000</td> <td>2500</td> </tr> </tbody> </table> <sup>2)</sup> Turn-on time <table border="1"> <thead> <tr> <th>Symbol of group</th> <th>T4</th> <th>P4</th> <th>M4</th> <th>K4</th> </tr> </thead> <tbody> <tr> <td><math>t_{gt}</math>, <math>\mu</math>s</td> <td>1.60</td> <td>2.00</td> <td>2.50</td> <td>3.20</td> </tr> </tbody> </table> <sup>3)</sup> Turn-off time ( $dv_D/dt=50$ V/ $\mu$ s) <table border="1"> <thead> <tr> <th>Symbol of group</th> <th>T3</th> <th>P3</th> <th>M3</th> <th>K3</th> </tr> </thead> <tbody> <tr> <td><math>t_{gr}</math>, <math>\mu</math>s</td> <td>16.0</td> <td>20.0</td> <td>25.0</td> <td>32.0</td> </tr> </tbody> </table>								Symbol of Group	P2	K2	E2	A2	T1	P1	M1	$(dv_D/dt)_{crit}$ , V/ $\mu$ s	200	320	500	1000	1600	2000	2500	Symbol of group	T4	P4	M4	K4	$t_{gt}$ , $\mu$ s	1.60	2.00	2.50	3.20	Symbol of group	T3	P3	M3	K3	$t_{gr}$ , $\mu$ s	16.0	20.0	25.0	32.0
Symbol of Group	P2	K2	E2	A2	T1	P1	M1																																												
$(dv_D/dt)_{crit}$ , V/ $\mu$ s	200	320	500	1000	1600	2000	2500																																												
Symbol of group	T4	P4	M4	K4																																															
$t_{gt}$ , $\mu$ s	1.60	2.00	2.50	3.20																																															
Symbol of group	T3	P3	M3	K3																																															
$t_{gr}$ , $\mu$ s	16.0	20.0	25.0	32.0																																															
1	2	3	4	5	6	7	8																																												
1. TFI — fast inverter thyristor 2. Design version 3. Mean on-state current, A 4. Voltage code 5. Critical rate of rise of off-state voltage 6. Group of turn-off time ( $dv_D/dt=50$ V/ $\mu$ s) 7. Group of turn-on time 8. Ambient conditions: N – normal; T – tropical																																																			



All dimensions in millimeters (inches)

The information contained herein is confidential and protected by Copyright.  
 In the interest of product improvement, Proton-Electrotex reserves the right to change data sheet without notice.

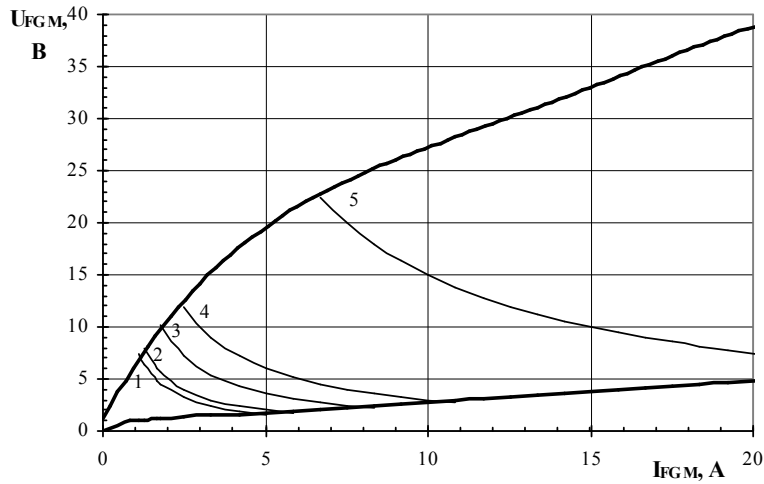


Analytical function for On-state characteristic:

$$V_T = A + B \cdot i_T + C \cdot \ln(i_T + 1) + D \cdot \sqrt{i_T}$$

	Coefficients for max curves	
	T <sub>j</sub> = 25°C	T <sub>j</sub> = T <sub>j max</sub>
<b>A</b>	1.18505800	0.79819854
<b>B</b>	0.00081072	0.00041865
<b>C</b>	0.18211655	0.08373927
<b>D</b>	-0.04290308	0.00317139

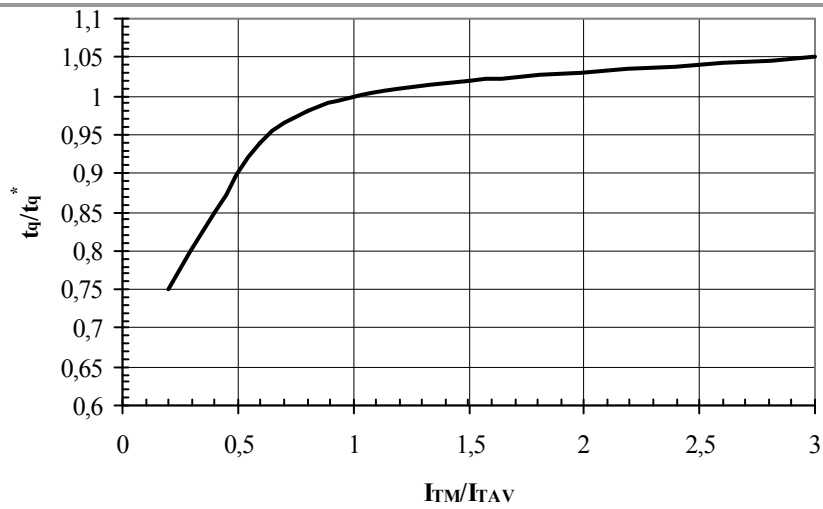
**Fig. 1** On-state characteristics of Limit device



Maximum peak gate power loss

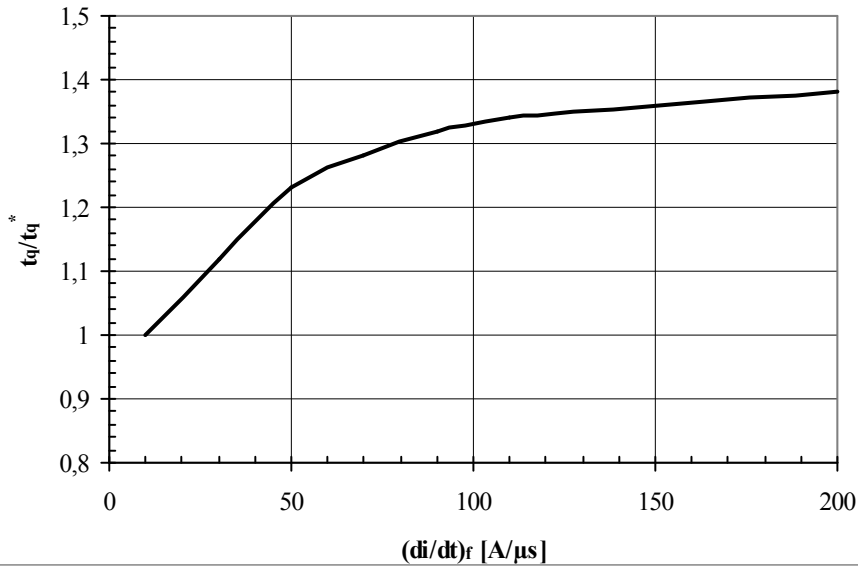
Position	On-Off time ratio	Gate pulse length, ms	Gate Pulse Power, W
1	1	DC	8
2	2	10	10
3	20	1	18
4	40	0.5	30
5	200	0.1	150

**Fig. 2** Gate characteristics



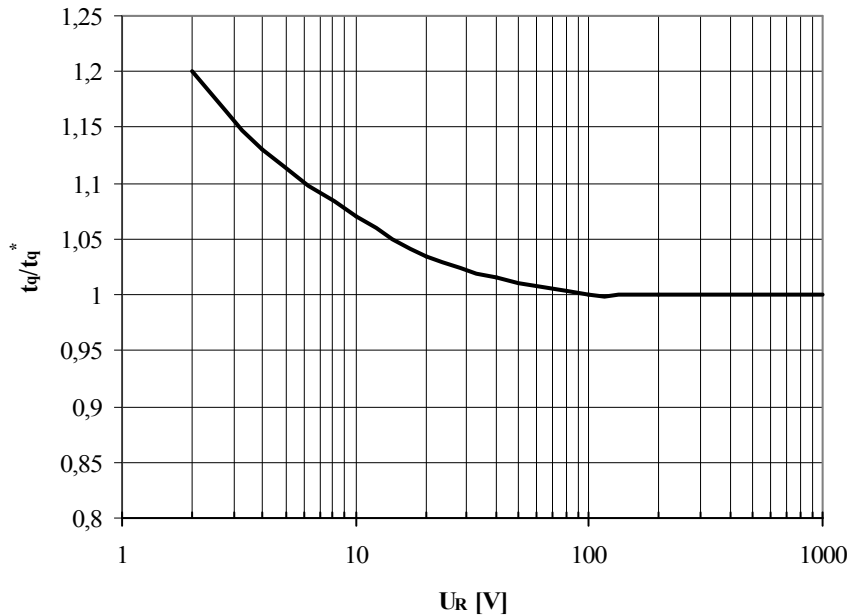
**Fig. 3** Turn-off time  $t_q$  vs. On-state peak current  $I_{TM}$

Conditions:  $T_j=T_{j\max}$ ;  $di_R/dt=10\text{ A}/\mu\text{s}$ ;  $V_R=100\text{ V}$ ;  $dv_D/dt=50\text{ V}/\mu\text{s}$ ;  $V_D=0.67\cdot V_{DRM}$   
 Typical changes of  $t_q$  are normalized to the  $t_q^*$  ( $t_q^*$  – see data sheet,  $dv_D/dt=50\text{ V}/\mu\text{s}$ )



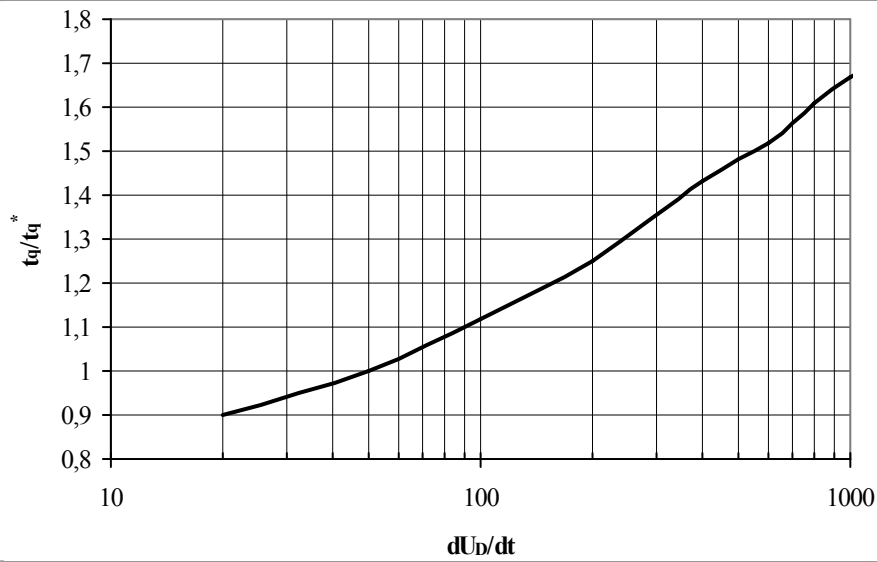
**Fig. 4** Turn-off time  $t_q$  vs. Rate of fall of on-state current  $di_R/dt$

Conditions:  $T_j=T_{j\max}$ ;  $I_{TM}=I_{TAV}$ ;  $V_R=100\text{ V}$ ;  $dv_D/dt=50\text{ V}/\mu\text{s}$ ;  $V_D=0.67\cdot V_{DRM}$   
 Typical changes of  $t_q$  are normalized to the  $t_q^*$  ( $t_q^*$  – see data sheet,  $dv_D/dt=50\text{ V}/\mu\text{s}$ )



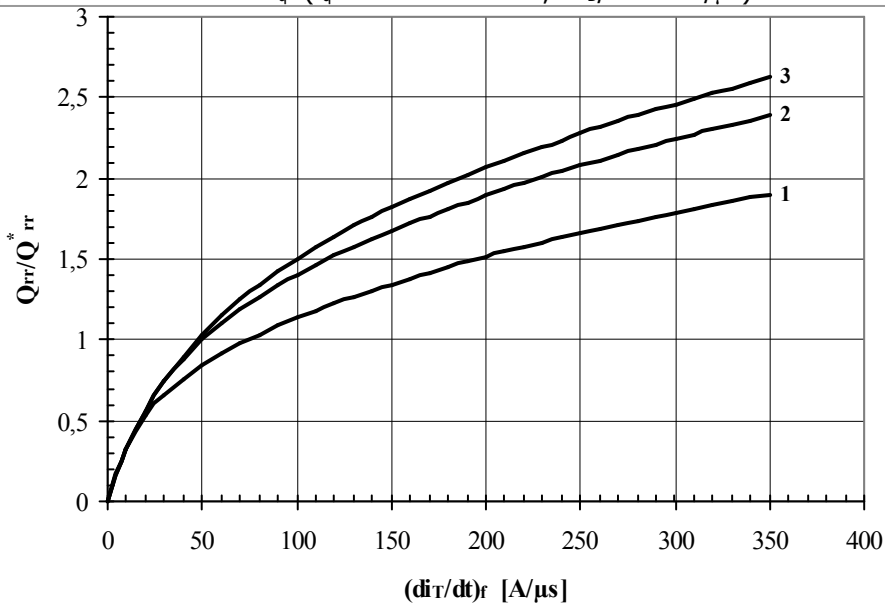
**Fig. 5** Turn-off time  $t_q$  vs. Reverse voltage  $V_R$

Conditions:  $T_j=T_{j\max}$ ;  $I_{TM}=I_{TAV}$ ;  $di_R/dt=10\text{ A}/\mu\text{s}$ ;  $dv_D/dt=50\text{ V}/\mu\text{s}$ ;  $V_D=0.67\cdot V_{DRM}$   
 Typical changes of  $t_q$  are normalized to the  $t_q^*$  ( $t_q^*$  – see data sheet,  $dv_D/dt=50\text{ V}/\mu\text{s}$ )



**Fig. 6** Turn-off time  $t_q$  vs. Rate of rise of commutating voltage  $dv_D/dt$

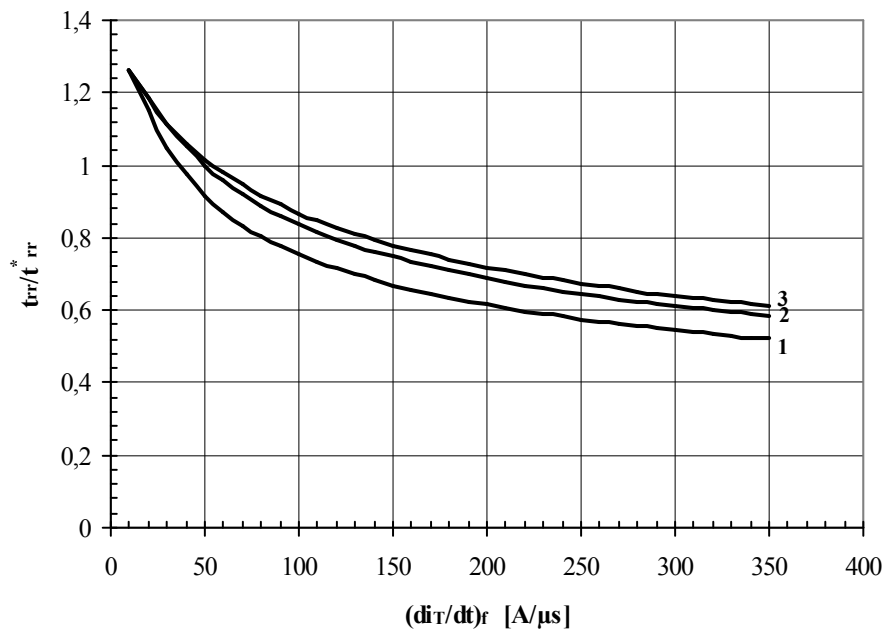
Conditions:  $T_j = T_{j\ max}$ ;  $I_{TM} = I_{TAV}$ ;  $di_R/dt = 10\ A/\mu s$ ;  $V_R = 100\ V$ ;  $V_D = 0.67 \cdot V_{DRM}$   
 Typical changes of  $t_q$  are normalized to the  $t_q^*$  ( $t_q^*$  – see data sheet,  $dv_D/dt = 50\ V/\mu s$ )



**Fig. 7** Reverse recovery charge  $Q_{rr}$  vs. Rate of fall of on-state current  $di_R/dt$

- 1 –  $I_{TM} = 0.5 \cdot I_{TAV}$
- 2 –  $I_{TM} = I_{TAV}$
- 3 –  $I_{TM} = 1.5 \cdot I_{TAV}$

Conditions:  $T_j = T_{j\ max}$ ;  $V_R = 100\ V$   
 Typical changes of  $Q_{rr}$  are normalized to the  $Q_{rr}^*$  ( $Q_{rr}^*$  – see data sheet)



**Fig. 8** Reverse recovery time  $t_{rr}$  vs. Rate of fall of on-state current  $di_R/dt$

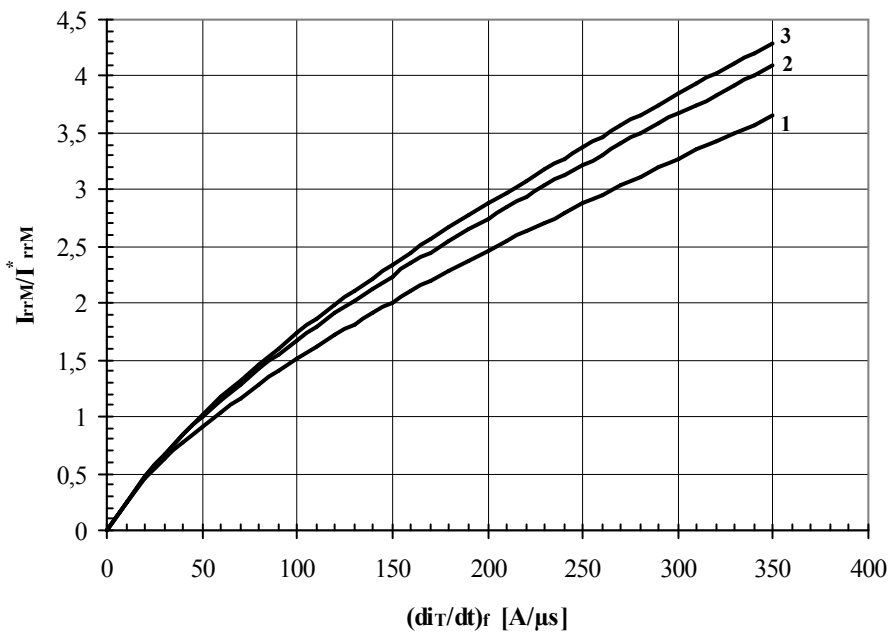
1 -  $I_{TM} = 0.5 \cdot I_{TAV}$

2 -  $I_{TM} = I_{TAV}$ ,

3 -  $I_{TM} = 1.5 \cdot I_{TAV}$

Conditions:  $T_j = T_{j \max}$ ;  $V_R = 100$  V

Typical changes of  $t_{rr}$  are normalized to the  $t_{rr}^*$  ( $t_{rr}^*$  – see data sheet)



**Fig. 9** Peak reverse recovery current  $I_{rrM}$  vs. Rate of fall of on-state current  $di_R/dt$

1 -  $I_{TM} = 0.5 \cdot I_{TAV}$

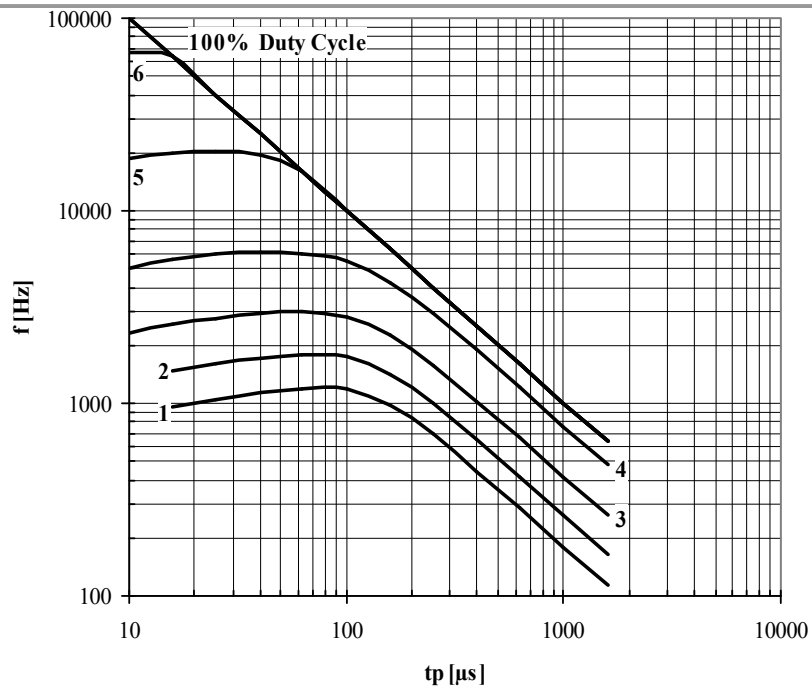
2 -  $I_{TM} = I_{TAV}$ ,

3 -  $I_{TM} = 1.5 \cdot I_{TAV}$

Conditions:  $T_j = T_{j \max}$ ;  $V_R = 100$  V

Typical changes of  $I_{rrM}$  are normalized to the  $I_{rrM}^*$  ( $I_{rrM}^*$  – see data sheet)

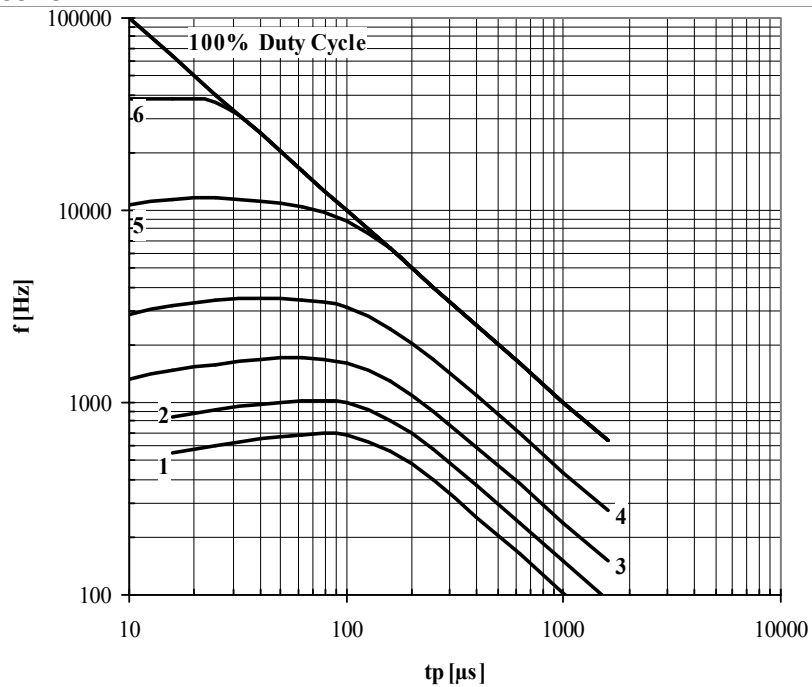




**Fig. 10** Sine wave frequency ratings

- 1 -  $I_{TM} = 5000$  A
- 2 -  $I_{TM} = 4000$  A
- 3 -  $I_{TM} = 3000$  A
- 4 -  $I_{TM} = 2000$  A
- 5 -  $I_{TM} = 1000$  A
- 6 -  $I_{TM} = 500$  A

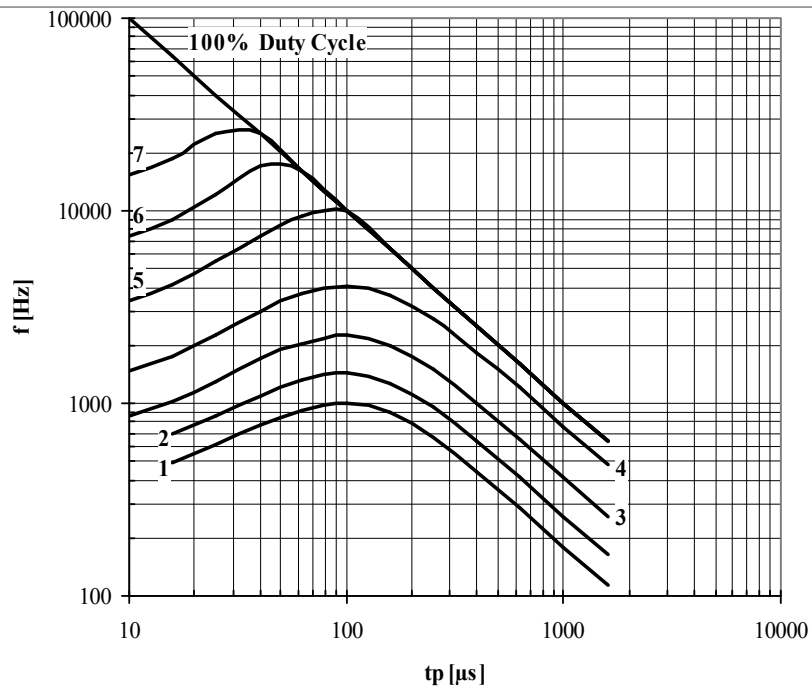
Conditions:  $V_R \leq 3$  V;  $T_C = 55$  °C



**Fig. 11** Sine wave frequency ratings

- 1 -  $I_{TM} = 5000$  A
- 2 -  $I_{TM} = 4000$  A
- 3 -  $I_{TM} = 3000$  A
- 4 -  $I_{TM} = 2000$  A
- 5 -  $I_{TM} = 1000$  A
- 6 -  $I_{TM} = 500$  A
- 7 -  $I_{TM} = 250$  A

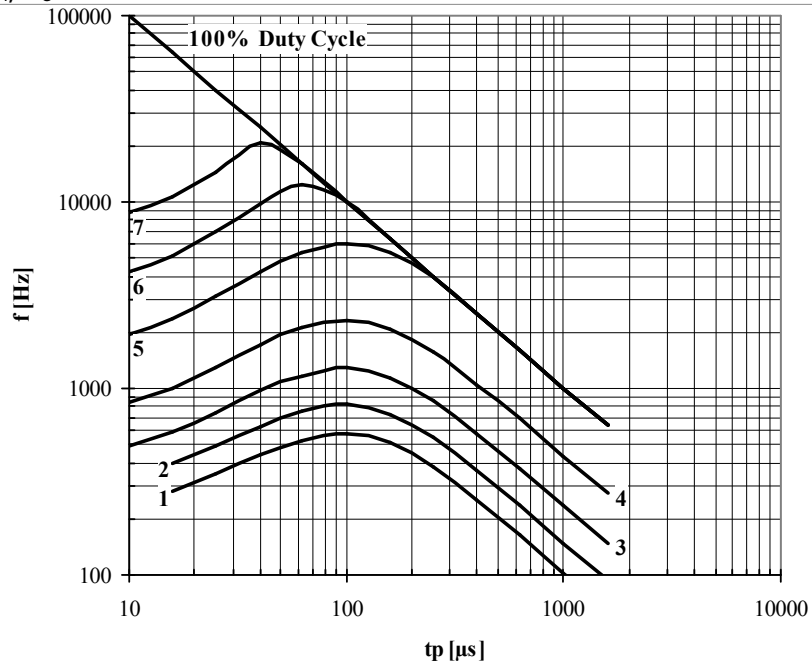
Conditions:  $V_R \leq 3$  V;  $T_C = 80$  °C



**Fig. 12** Sine wave frequency ratings

- 1 -  $I_{TM} = 5000$  A
- 2 -  $I_{TM} = 4000$  A
- 3 -  $I_{TM} = 3000$  A
- 4 -  $I_{TM} = 2000$  A
- 5 -  $I_{TM} = 1000$  A
- 6 -  $I_{TM} = 500$  A
- 7 -  $I_{TM} = 250$  A

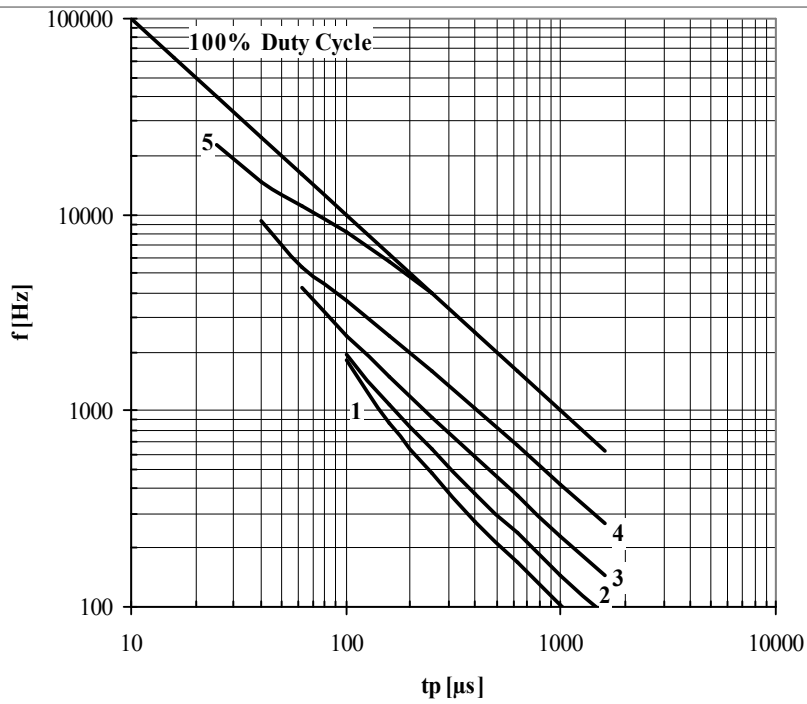
Conditions:  $V_R = 0.67 \cdot V_{RRM}$ ;  $T_C = 55$  °C



**Fig. 13** Sine wave frequency ratings

- 1 -  $I_{TM} = 5000$  A
- 2 -  $I_{TM} = 4000$  A
- 3 -  $I_{TM} = 3000$  A
- 4 -  $I_{TM} = 2000$  A
- 5 -  $I_{TM} = 1000$  A
- 6 -  $I_{TM} = 500$  A
- 7 -  $I_{TM} = 250$  A

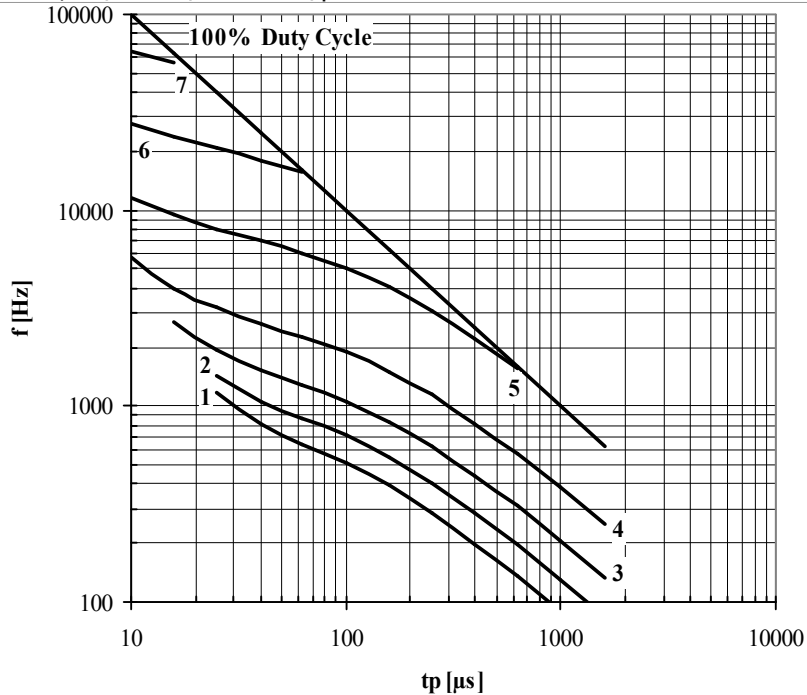
Conditions:  $V_R = 0.67 \cdot V_{RRM}$ ;  $T_C = 80$  °C



**Fig. 14** Square wave frequency ratings

- 1 -  $I_{TM} = 5000$  A
- 2 -  $I_{TM} = 4000$  A
- 3 -  $I_{TM} = 3000$  A
- 4 -  $I_{TM} = 2000$  A
- 5 -  $I_{TM} = 1000$  A
- 6 -  $I_{TM} = 500$  A

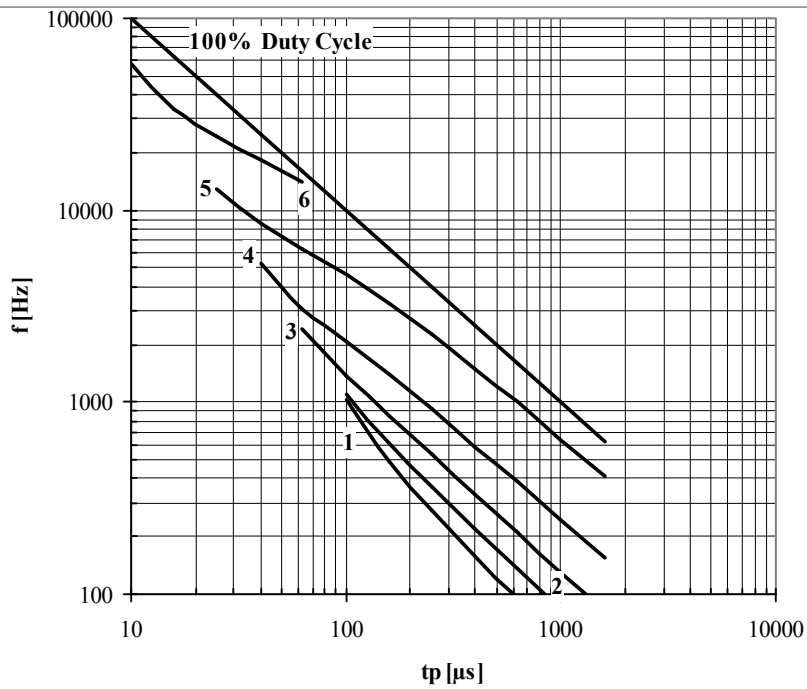
Conditions:  $V_R \leq 3$  V;  $T_C = 55$  °C;  $di_F/dt = di_R/dt = 100$  A/ $\mu$ s



**Fig. 15** Square wave frequency ratings

- 1 -  $I_{TM} = 5000$  A
- 2 -  $I_{TM} = 4000$  A
- 3 -  $I_{TM} = 3000$  A
- 4 -  $I_{TM} = 2000$  A
- 5 -  $I_{TM} = 1000$  A
- 6 -  $I_{TM} = 500$  A
- 7 -  $I_{TM} = 250$  A

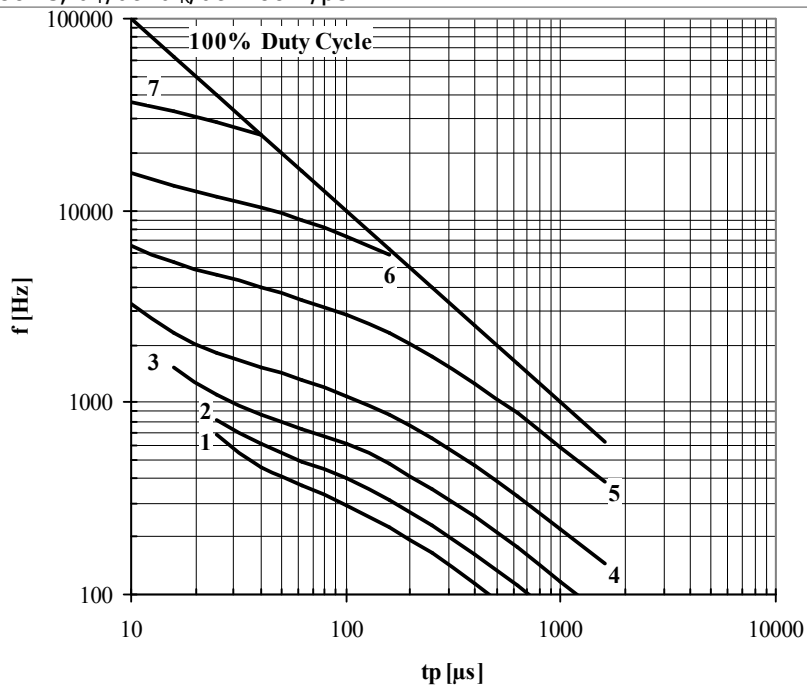
Conditions:  $V_R \leq 3$  V;  $T_C = 55$  °C;  $di_F/dt = di_R/dt = 500$  A/ $\mu$ s



**Fig. 16** Square wave frequency ratings

- 1 -  $I_{TM} = 5000$  A
- 2 -  $I_{TM} = 4000$  A
- 3 -  $I_{TM} = 3000$  A
- 4 -  $I_{TM} = 2000$  A
- 5 -  $I_{TM} = 1000$  A
- 6 -  $I_{TM} = 500$  A
- 7 -  $I_{TM} = 250$  A

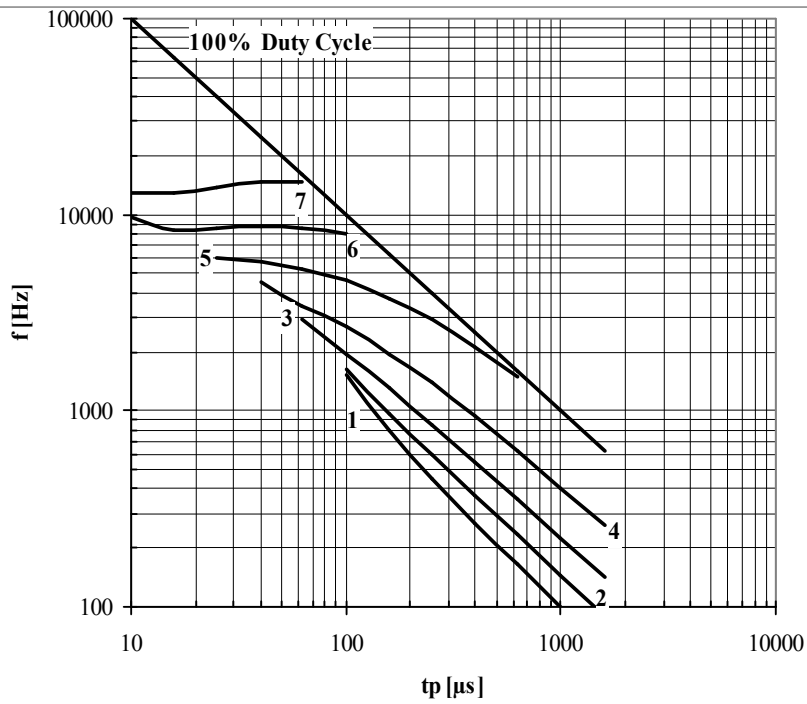
Conditions:  $V_R \leq 3$  V;  $T_C = 80$  °C;  $di_F/dt = di_R/dt = 100$  A/ $\mu$ s



**Fig. 17** Square wave frequency ratings

- 1 -  $I_{TM} = 5000$  A
- 2 -  $I_{TM} = 4000$  A
- 3 -  $I_{TM} = 3000$  A
- 4 -  $I_{TM} = 2000$  A
- 5 -  $I_{TM} = 1000$  A
- 6 -  $I_{TM} = 500$  A
- 7 -  $I_{TM} = 250$  A

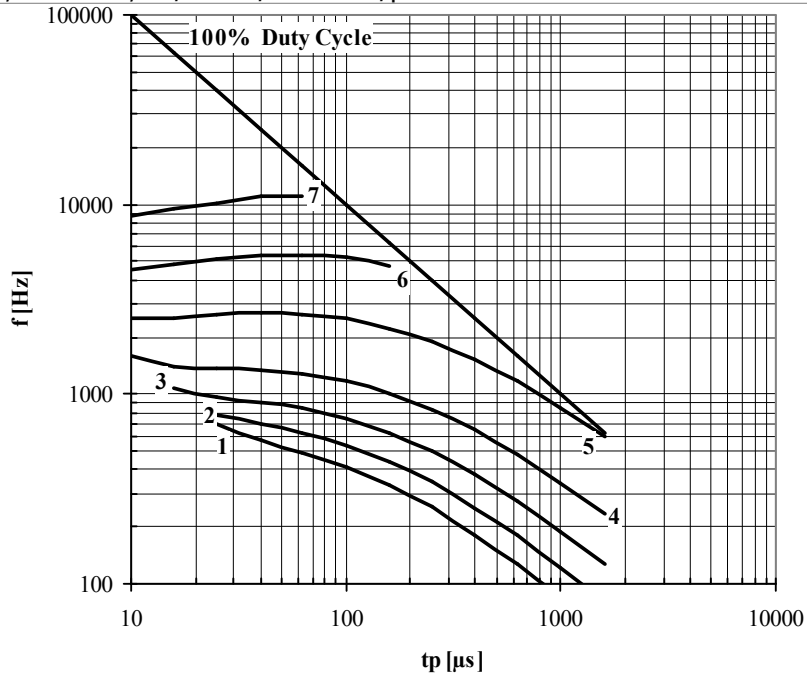
Conditions:  $V_R \leq 3$  V;  $T_C = 80$  °C;  $di_F/dt = di_R/dt = 500$  A/ $\mu$ s



**Fig. 18** Square wave frequency ratings

- 1 -  $I_{TM} = 5000 \text{ A}$
- 2 -  $I_{TM} = 4000 \text{ A}$
- 3 -  $I_{TM} = 3000 \text{ A}$
- 4 -  $I_{TM} = 2000 \text{ A}$
- 5 -  $I_{TM} = 1000 \text{ A}$
- 6 -  $I_{TM} = 500 \text{ A}$
- 7 -  $I_{TM} = 250 \text{ A}$

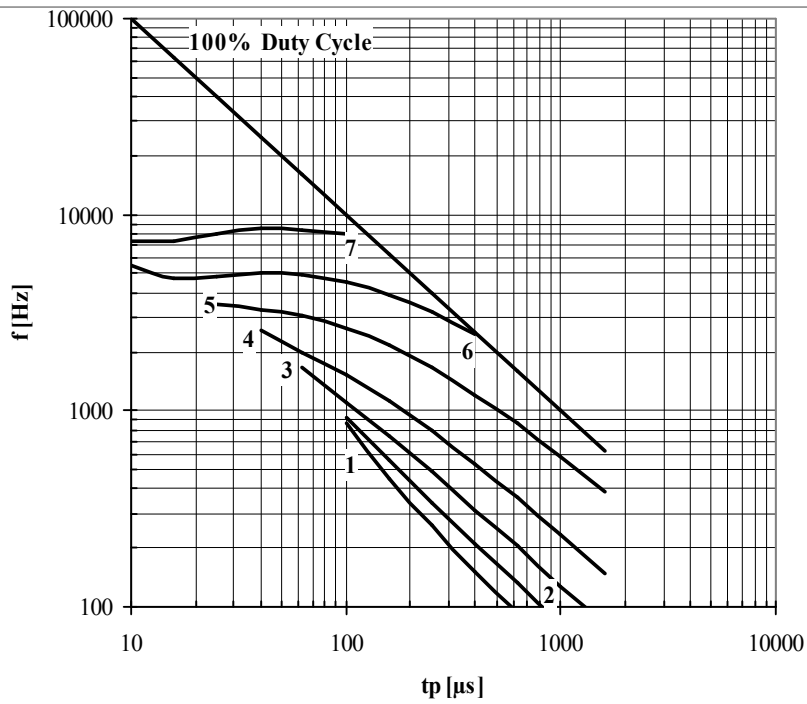
Conditions:  $V_R = 0.67 \cdot V_{RRM}$ ;  $T_C = 55 \text{ }^\circ\text{C}$ ;  $di_F/dt = di_R/dt = 100 \text{ A}/\mu\text{s}$



**Fig. 19** Square wave frequency ratings

- 1 -  $I_{TM} = 5000 \text{ A}$
- 2 -  $I_{TM} = 4000 \text{ A}$
- 3 -  $I_{TM} = 3000 \text{ A}$
- 4 -  $I_{TM} = 2000 \text{ A}$
- 5 -  $I_{TM} = 1000 \text{ A}$
- 6 -  $I_{TM} = 500 \text{ A}$
- 7 -  $I_{TM} = 250 \text{ A}$

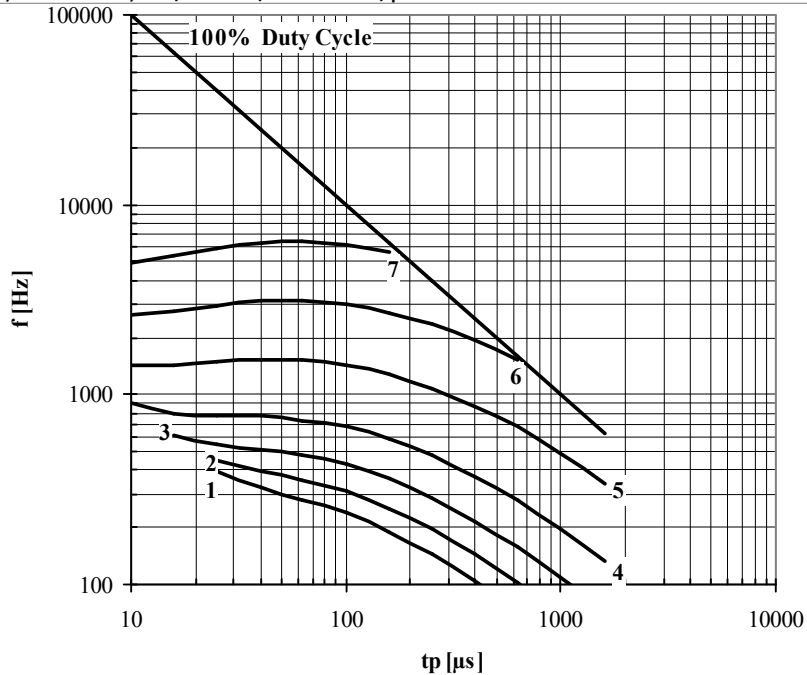
Conditions:  $V_R = 0.67 \cdot V_{RRM}$ ;  $T_C = 55 \text{ }^\circ\text{C}$ ;  $di_F/dt = di_R/dt = 500 \text{ A}/\mu\text{s}$



**Fig. 20** Square wave frequency ratings

- 1 -  $I_{TM} = 5000 \text{ A}$
- 2 -  $I_{TM} = 4000 \text{ A}$
- 3 -  $I_{TM} = 3000 \text{ A}$
- 4 -  $I_{TM} = 2000 \text{ A}$
- 5 -  $I_{TM} = 1000 \text{ A}$
- 6 -  $I_{TM} = 500 \text{ A}$
- 7 -  $I_{TM} = 250 \text{ A}$

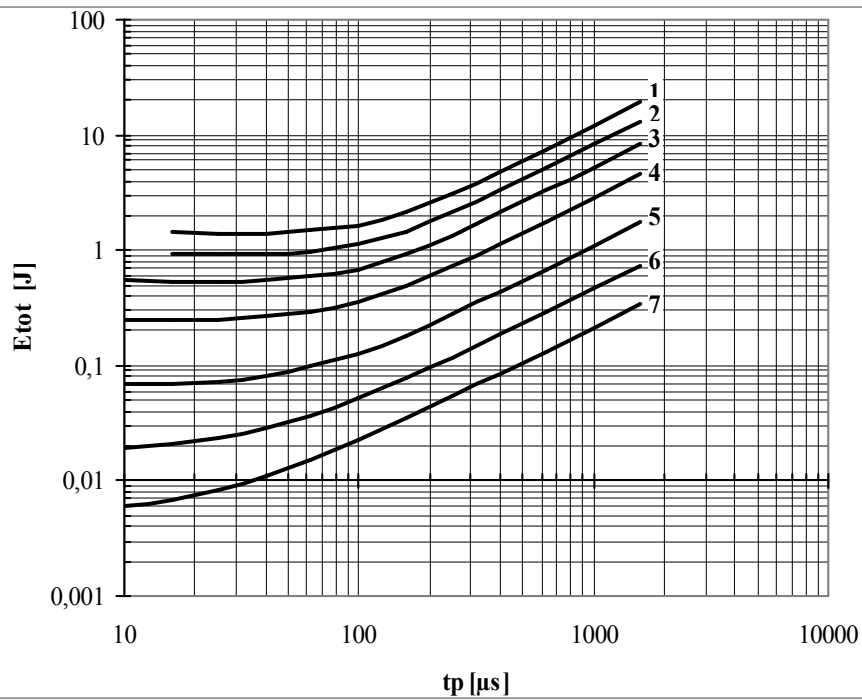
Conditions:  $V_R = 0.67 \cdot V_{RRM}$ ;  $T_C = 80 \text{ }^\circ\text{C}$ ;  $di_F/dt = di_R/dt = 100 \text{ A}/\mu\text{s}$



**Fig. 21** Square wave frequency ratings

- 1 -  $I_{TM} = 5000 \text{ A}$
- 2 -  $I_{TM} = 4000 \text{ A}$
- 3 -  $I_{TM} = 3000 \text{ A}$
- 4 -  $I_{TM} = 2000 \text{ A}$
- 5 -  $I_{TM} = 1000 \text{ A}$
- 6 -  $I_{TM} = 500 \text{ A}$
- 7 -  $I_{TM} = 250 \text{ A}$

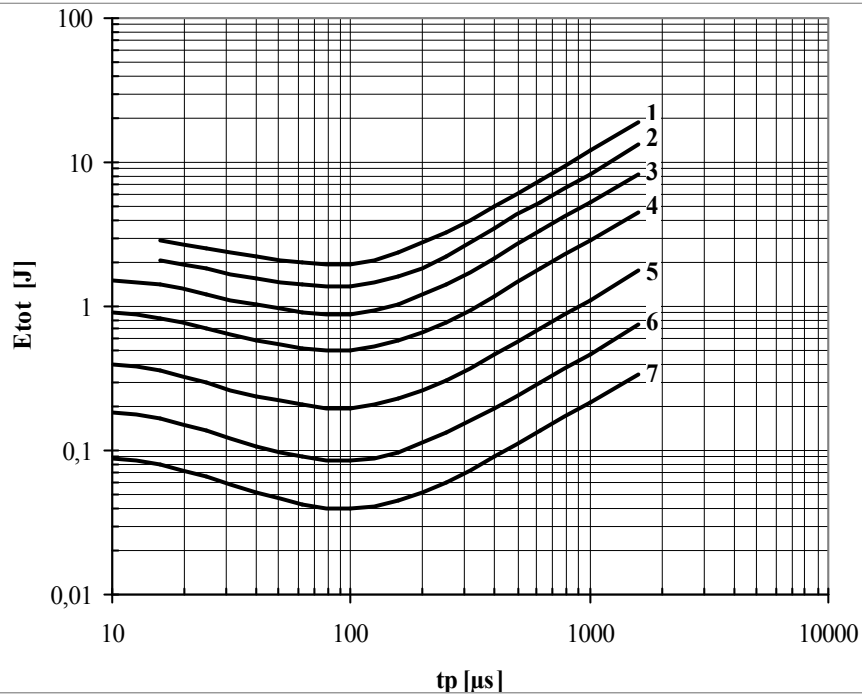
Conditions:  $V_R = 0.67 \cdot V_{RRM}$ ;  $T_C = 80 \text{ }^\circ\text{C}$ ;  $di_F/dt = di_R/dt = 500 \text{ A}/\mu\text{s}$



**Fig. 22** Sine wave loss energy per pulse

- 1 -  $I_{TM} = 5000$  A
- 2 -  $I_{TM} = 4000$  A
- 3 -  $I_{TM} = 3000$  A
- 4 -  $I_{TM} = 2000$  A
- 5 -  $I_{TM} = 1000$  A
- 6 -  $I_{TM} = 500$  A
- 7 -  $I_{TM} = 250$  A

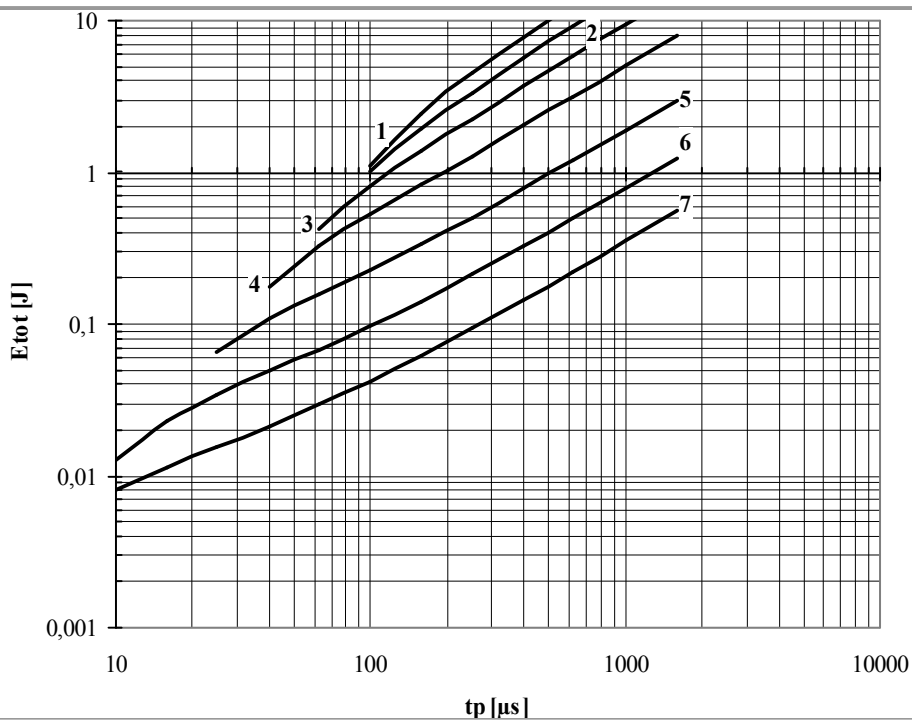
Conditions:  $V_R \leq 3$  V



**Fig. 23** Sine wave loss energy per pulse

- 1 -  $I_{TM} = 5000$  A
- 2 -  $I_{TM} = 4000$  A
- 3 -  $I_{TM} = 3000$  A
- 4 -  $I_{TM} = 2000$  A
- 5 -  $I_{TM} = 1000$  A
- 6 -  $I_{TM} = 500$  A
- 7 -  $I_{TM} = 250$  A

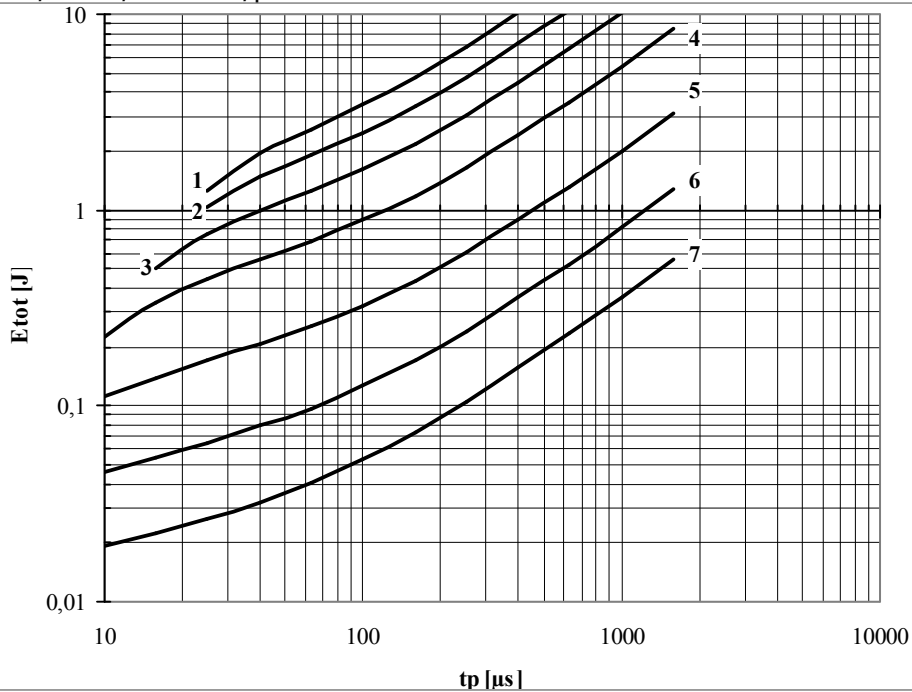
Conditions:  $V_R = 0.67 \cdot V_{RRM}$



**Fig. 24** Square wave loss energy per pulse

- 1 -  $I_{TM} = 5000$  A
- 2 -  $I_{TM} = 4000$  A
- 3 -  $I_{TM} = 3000$  A
- 4 -  $I_{TM} = 2000$  A
- 5 -  $I_{TM} = 1000$  A
- 6 -  $I_{TM} = 500$  A
- 7 -  $I_{TM} = 250$  A

Conditions:  $V_R \leq 3$  V;  $di_F/dt = di_R/dt = 100$  A/ $\mu s$

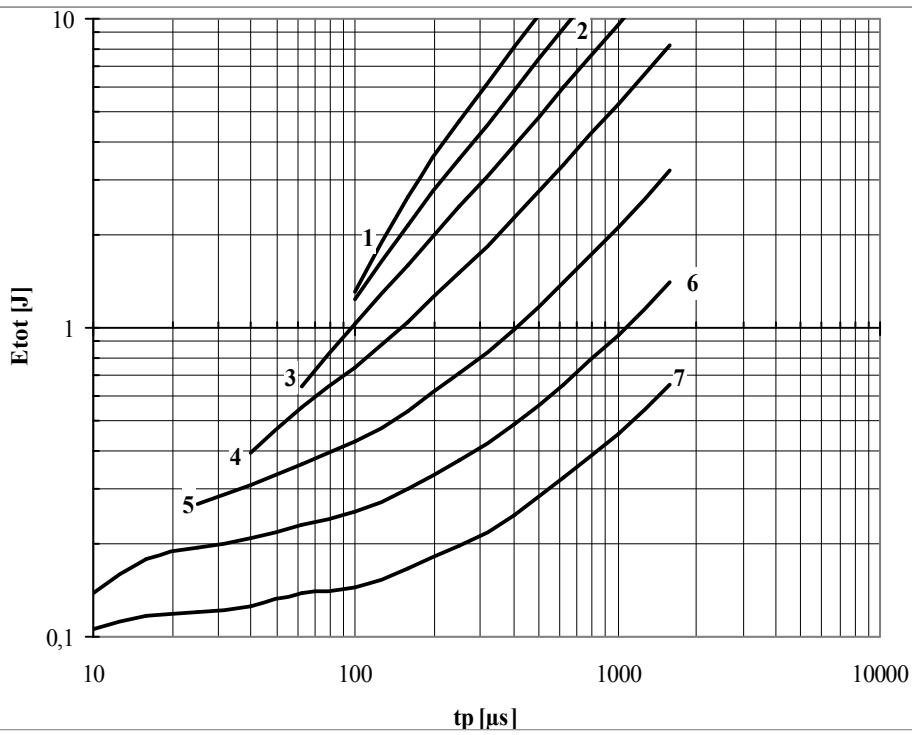


**Fig. 25** Square wave loss energy per pulse

- 1 -  $I_{TM} = 5000$  A
- 2 -  $I_{TM} = 4000$  A
- 3 -  $I_{TM} = 3000$  A
- 4 -  $I_{TM} = 2000$  A
- 5 -  $I_{TM} = 1000$  A
- 6 -  $I_{TM} = 500$  A
- 7 -  $I_{TM} = 250$  A

Conditions:  $V_R \leq 3$  V;  $di_F/dt = di_R/dt = 500$  A/ $\mu s$

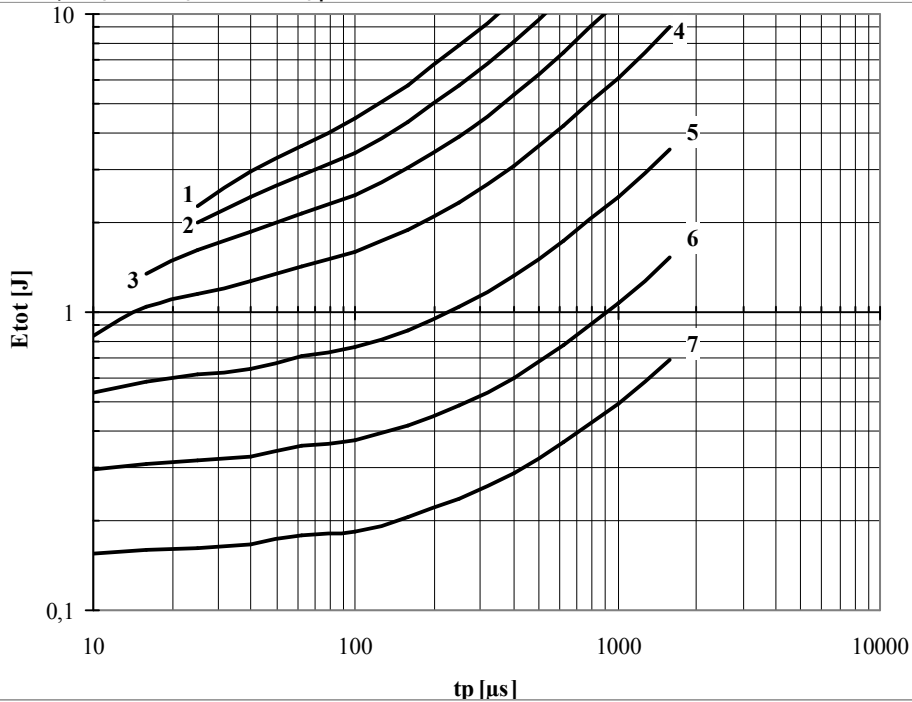




**Fig. 26** Square wave loss energy per pulse

- 1 -  $I_{TM} = 5000$  A
- 2 -  $I_{TM} = 4000$  A
- 3 -  $I_{TM} = 3000$  A
- 4 -  $I_{TM} = 2000$  A
- 5 -  $I_{TM} = 1000$  A
- 6 -  $I_{TM} = 500$  A
- 7 -  $I_{TM} = 250$  A

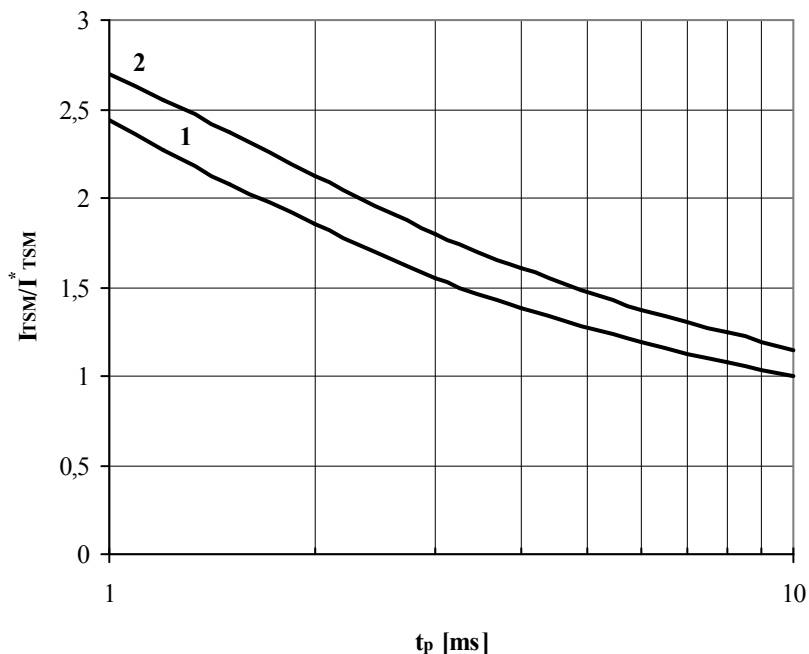
Conditions:  $V_R = 0.67 V_{RRM}$ ;  $di_F/dt = di_R/dt = 100$  A/ $\mu$ s



**Fig. 27** Square wave loss energy per pulse

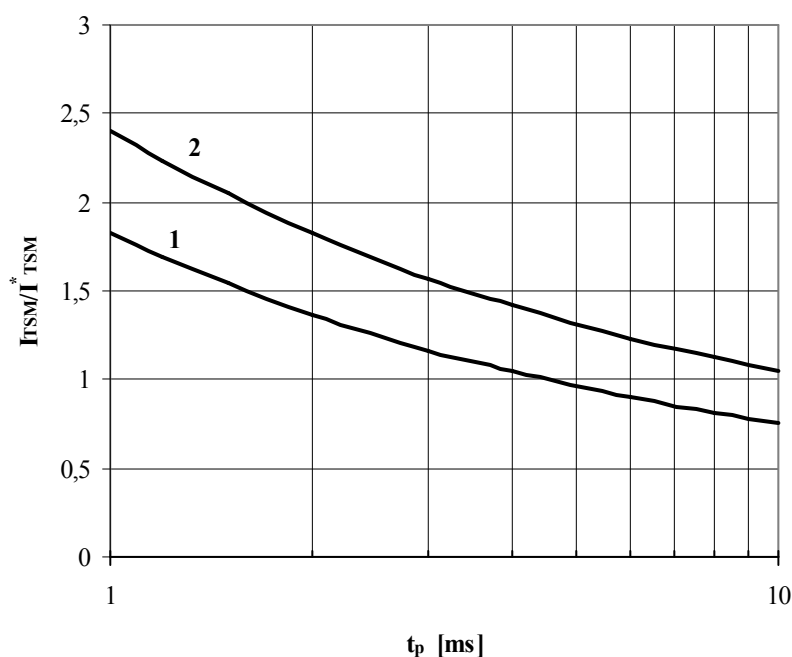
- 1 -  $I_{TM} = 5000$  A
- 2 -  $I_{TM} = 4000$  A
- 3 -  $I_{TM} = 3000$  A
- 4 -  $I_{TM} = 2000$  A
- 5 -  $I_{TM} = 1000$  A
- 6 -  $I_{TM} = 500$  A
- 7 -  $I_{TM} = 250$  A

Conditions:  $V_R = 0.67 V_{RRM}$ ;  $di_F/dt = di_R/dt = 500$  A/ $\mu$ s



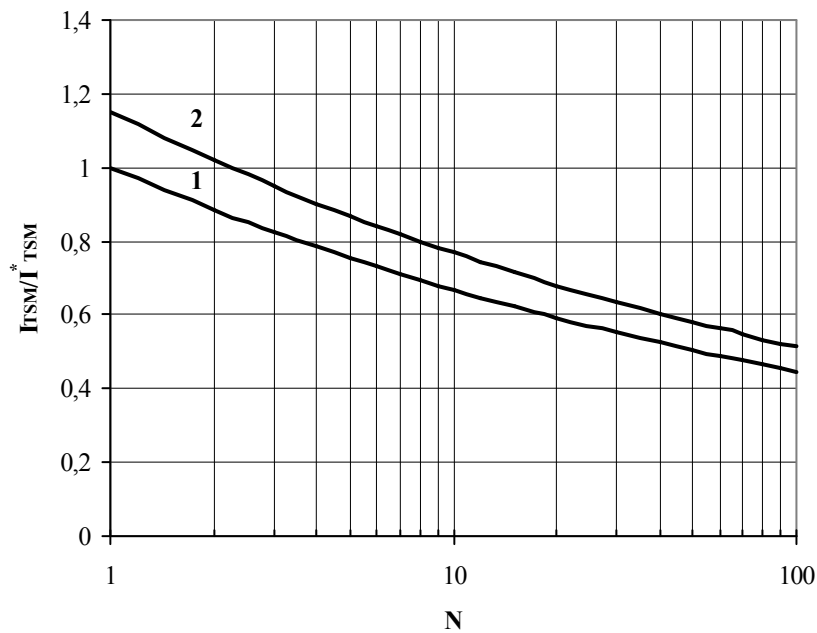
**Fig. 28** The surge current  $I_{TSM}$  vs. Duration of surge  $t_p$  for a half-sine wave  
 1 –  $T_j=125\text{ °C}$   
 2 –  $T_j=25\text{ °C}$

Conditions:  $V_R=0\text{ V}$  – the peak value of reverse voltage which is applied immediately after the surge current  
 Typical changes of  $I_{TSM}$  are normalized to the  $I_{TSM}^*$  ( $I_{TSM}^*$  – see data sheet,  $T_j=T_{j\text{ max}}$ )



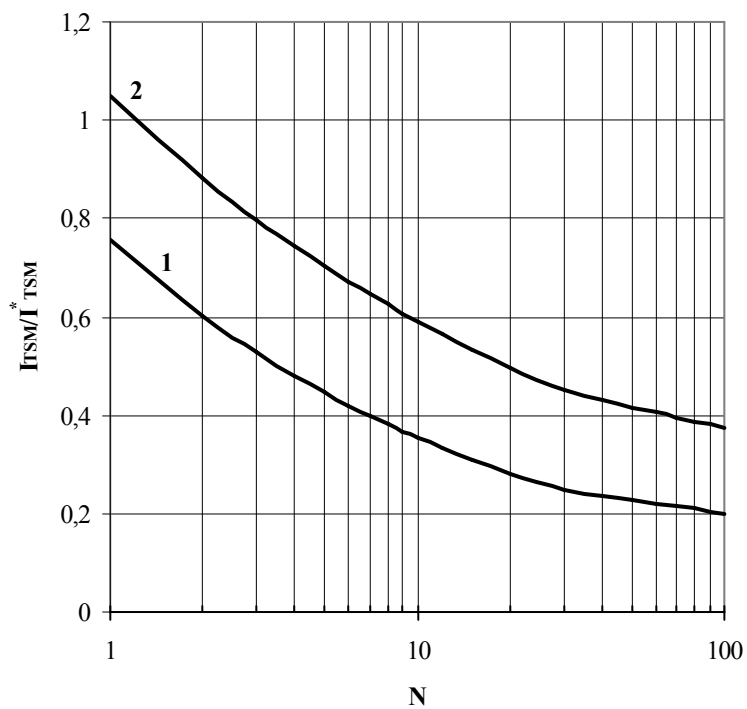
**Fig. 29** The surge current  $I_{TSM}$  vs. Duration of surge  $t_p$  for a half-sine wave  
 1 –  $T_j=125\text{ °C}$   
 2 –  $T_j=25\text{ °C}$

Conditions:  $V_R=0.8\cdot V_{RRM}$  – the peak value of reverse voltage which is applied immediately after the surge current  
 Typical changes of  $I_{TSM}$  are normalized to the  $I_{TSM}^*$  ( $I_{TSM}^*$  – see data sheet,  $T_j=T_{j\text{ max}}$ )



**Fig. 30** The surge current  $I_{TSM}$  vs. Number of half-sine waves at 50 Hz  
 1 –  $T_j=125^\circ\text{C}$   
 2 –  $T_j=25^\circ\text{C}$

Conditions:  $V_R=0\text{ V}$  – the peak value of reverse voltage which is applied immediately after the surge current  
 Typical changes of  $I_{TSM}$  are normalized to the  $I_{TSM}^*$  ( $I_{TSM}^*$  – see data sheet,  $T_j=T_{j\text{max}}$ )



**Fig. 31** The surge current  $I_{TSM}$  vs. Number of half-sine waves at 50 Hz  
 1 –  $T_j=125^\circ\text{C}$   
 2 –  $T_j=25^\circ\text{C}$

Conditions:  $V_R=0.8 \cdot V_{RRM}$  – the peak value of reverse voltage which is applied immediately after the surge current  
 Typical changes of  $I_{TSM}$  are normalized to the  $I_{TSM}^*$  ( $I_{TSM}^*$  – see data sheet,  $T_j=T_{j\text{max}}$ )