



Optimum power handling
Low on-state and switching losses
Designed for traction and industrial applications

Phase Control Stud Thyristor Type T371-250-8

Mean on-state current				I_{TAV}		250 A		
Repetitive peak off-state voltage				V_{DRM}		100÷800 V		
Repetitive peak reverse voltage				V_{RRM}				
Turn-off time				t_q		125, 160, 200, 250, 320, 400, 500 μs		
V_{DRM}, V_{RRM}, V	100	200	300	400	500	600	700	800
Voltage code	1	2	3	4	5	6	7	8
$T_j, ^\circ C$	-60÷150							

MAXIMUM ALLOWABLE RATINGS

Symbols and parameters		Units	Values	Test conditions	
ON-STATE					
I_{TAV}	Mean on-state current	A	250 409	$T_c = 123\text{ }^\circ C$; $T_c = 100\text{ }^\circ C$; 180° half-sine wave; 50 Hz	
I_{TRMS}	RMS on-state current	A	393	$T_c = 123\text{ }^\circ C$; 180° half-sine wave; 50 Hz	
I_{TSM}	Surge on-state current	kA	10.0 11.5	$T_j = T_{j\max}$ $T_j = 25\text{ }^\circ C$	180° half-sine wave; $t_p = 10\text{ ms}$; single pulse; $V_D = V_R = 0\text{ V}$; Gate pulse: $I_G = 2\text{ A}$; $t_{GP} = 50\text{ }\mu s$; $di_G/dt \geq 1\text{ A}/\mu s$
			10.5 12.0	$T_j = T_{j\max}$ $T_j = 25\text{ }^\circ C$	180° half-sine wave; $t_p = 8.3\text{ ms}$; single pulse; $V_D = V_R = 0\text{ V}$; Gate pulse: $I_G = 2\text{ A}$; $t_{GP} = 50\text{ }\mu s$; $di_G/dt \geq 1\text{ A}/\mu s$
I^2t	Safety factor	$A^2s \cdot 10^3$	500 660	$T_j = T_{j\max}$ $T_j = 25\text{ }^\circ C$	180° half-sine wave; $t_p = 10\text{ ms}$; single pulse; $V_D = V_R = 0\text{ V}$; Gate pulse: $I_G = 2\text{ A}$; $t_{GP} = 50\text{ }\mu s$; $di_G/dt \geq 1\text{ A}/\mu s$
			450 590	$T_j = T_{j\max}$ $T_j = 25\text{ }^\circ C$	180° half-sine wave; $t_p = 8.3\text{ ms}$; single pulse; $V_D = V_R = 0\text{ V}$; Gate pulse: $I_G = 2\text{ A}$; $t_{GP} = 50\text{ }\mu s$; $di_G/dt \geq 1\text{ A}/\mu s$
BLOCKING					
V_{DRM}, V_{RRM}	Repetitive peak off-state and Repetitive peak reverse voltages	V	100÷800	$T_{j\min} < T_j < T_{j\max}$; 180° half-sine wave; 50 Hz; Gate open	
V_{DSM}, V_{RSM}	Non-repetitive peak off-state and Non-repetitive peak reverse voltages	V	200÷900	$T_{j\min} < T_j < T_{j\max}$; 180° half-sine wave; single pulse; Gate open	
V_D, V_R	Direct off-state and Direct reverse voltages	V	$0.6 \cdot V_{DRM}$ $0.6 \cdot V_{RRM}$	$T_j = T_{j\max}$; Gate open	

TRIGGERING				
I_{FGM}	Peak forward gate current	A	6	$T_j = T_{j\max}$
V_{RGM}	Peak reverse gate voltage	V	5	
P_G	Gate power dissipation	W	3	$T_j = T_{j\max}$ for DC gate current
SWITCHING				
$(di_T/dt)_{crit}$	Critical rate of rise of on-state current non-repetitive (f=1 Hz)	A/ μ s	800	$T_j = T_{j\max}$; $V_D = 0.67 \cdot V_{DRM}$; $I_{TM} = 3000$ A; Gate pulse: $I_G = 2$ A; $t_{GP} = 50$ μ s; $di_G/dt \geq 2$ A/ μ s
THERMAL				
T_{stg}	Storage temperature	$^{\circ}$ C	-60÷50	
T_j	Operating junction temperature	$^{\circ}$ C	-60÷150	
MECHANICAL				
M	Tightening torque	Nm	25÷35	
a	Acceleration	m/s ²	100	

CHARACTERISTICS

Symbols and parameters		Units	Values	Conditions	
ON-STATE					
V_{TM}	Peak on-state voltage, max	V	1.35	$T_j = 25$ $^{\circ}$ C; $I_{TM} = 785$ A	
$V_{T(TO)}$	On-state threshold voltage, max	V	0.906	$T_j = T_{j\max}$;	
r_T	On-state slope resistance, max	m Ω	0.531	$0.5 \pi I_{TAV} < I_T < 1.5 \pi I_{TAV}$	
I_L	Latching current, max	mA	700	$T_j = 25$ $^{\circ}$ C; $V_D = 12$ V; Gate pulse: $I_G = 2$ A; $t_{GP} = 50$ μ s; $di_G/dt \geq 1$ A/ μ s	
I_H	Holding current, max	mA	300	$T_j = 25$ $^{\circ}$ C; $V_D = 12$ V; Gate open	
BLOCKING					
I_{DRM}, I_{RRM}	Repetitive peak off-state and Repetitive peak reverse currents, max	mA	70	$T_j = T_{j\max}$; $V_D = V_{DRM}$; $V_R = V_{RRM}$	
$(dv_D/dt)_{crit}$	Critical rate of rise of off-state voltage ¹⁾ , min	V/ μ s	200, 320, 500, 1000	$T_j = T_{j\max}$; $V_D = 0.67 \cdot V_{DRM}$; Gate open	
TRIGGERING					
V_{GT}	Gate trigger direct voltage, max	V	3.00	$T_j = T_{j\min}$ $T_j = 25$ $^{\circ}$ C $T_j = T_{j\max}$	$V_D = 12$ V; $I_D = 3$ A; Direct gate current
			2.50		
I_{GT}	Gate trigger direct current, max	mA	400	$T_j = T_{j\min}$ $T_j = 25$ $^{\circ}$ C $T_j = T_{j\max}$	
			250		
			150		
V_{GD}	Gate non-trigger direct voltage, min	V	0.50	$T_j = T_{j\max}$;	
I_{GD}	Gate non-trigger direct current, min	mA	35.00	$V_D = 0.67 \cdot V_{DRM}$; Direct gate current	
SWITCHING					
t_{gd}	Delay time, max	μ s	0.70	$T_j = 25$ $^{\circ}$ C; $V_D = 600$ V; $I_{TM} = I_{TAV}$; $di/dt = 200$ A/ μ s;	
t_{gt}	Turn-on time, max	μ s	3.00	Gate pulse: $I_G = 2$ A; $V_G = 20$ V; $t_{GP} = 50$ μ s; $di_G/dt = 2$ A/ μ s	
t_q	Turn-off time ²⁾ , max	μ s	125, 160, 200, 250, 320, 400, 500	$dv_D/dt = 50$ V/ μ s; $T_j = T_{j\max}$; $I_{TM} = I_{TAV}$; $di_R/dt = -10$ A/ μ s; $V_R = 100$ V; $V_D = 0.67 \cdot V_{DRM}$	
Q_{rr}	Total recovered charge, max	μ C	750	$T_j = T_{j\max}$; $I_{TM} = 250$ A;	
t_{rr}	Reverse recovery time, max	μ s	15	$di_R/dt = -10$ A/ μ s;	
I_{rrM}	Peak reverse recovery current, max	A	100	$V_R = 100$ V	

THERMAL				
R_{thjc}	Thermal resistance, junction to case, max	$^{\circ}\text{C}/\text{W}$	0.0850	Direct current
MECHANICAL				
w	Weight, max	g	470	
D_s	Surface creepage distance	mm (inch)	12.4 (4.882)	
D_a	Air strike distance	mm (inch)	12.4 (4.882)	

PART NUMBERING GUIDE							NOTES																																
T	371	250	8	A2	E2	N																																	
1	2	3	4	5	6	7																																	
1. Phase Control Thyristor 2. Design version 3. Mean on-state current, A 4. Voltage code 5. Critical rate of rise of off-state voltage, $\text{V}/\mu\text{s}$ 6. Turn-off time ($dv_D/dt=50 \text{ V}/\mu\text{s}$) 7. Ambient conditions: N – normal; T – tropical							1) Critical rate of rise of off-state voltage <table border="1"> <thead> <tr> <th>Symbol of Group</th> <th>P2</th> <th>K2</th> <th>E2</th> <th>A2</th> </tr> </thead> <tbody> <tr> <td>$(dv_D/dt)_{crit}, \text{V}/\mu\text{s}$</td> <td>200</td> <td>320</td> <td>500</td> <td>1000</td> </tr> </tbody> </table> 2) Turn-off time ($dv_D/dt=50 \text{ V}/\mu\text{s}$) <table border="1"> <thead> <tr> <th>Symbol of Group</th> <th>X2</th> <th>T2</th> <th>P2</th> <th>M2</th> <th>K2</th> <th>H2</th> <th>E2</th> </tr> </thead> <tbody> <tr> <td>$t_q, \mu\text{s}$</td> <td>125</td> <td>160</td> <td>200</td> <td>250</td> <td>320</td> <td>400</td> <td>500</td> </tr> </tbody> </table>							Symbol of Group	P2	K2	E2	A2	$(dv_D/dt)_{crit}, \text{V}/\mu\text{s}$	200	320	500	1000	Symbol of Group	X2	T2	P2	M2	K2	H2	E2	$t_q, \mu\text{s}$	125	160	200	250	320	400	500
Symbol of Group	P2	K2	E2	A2																																			
$(dv_D/dt)_{crit}, \text{V}/\mu\text{s}$	200	320	500	1000																																			
Symbol of Group	X2	T2	P2	M2	K2	H2	E2																																
$t_q, \mu\text{s}$	125	160	200	250	320	400	500																																

OVERALL DIMENSIONS

Package type: T.SB2

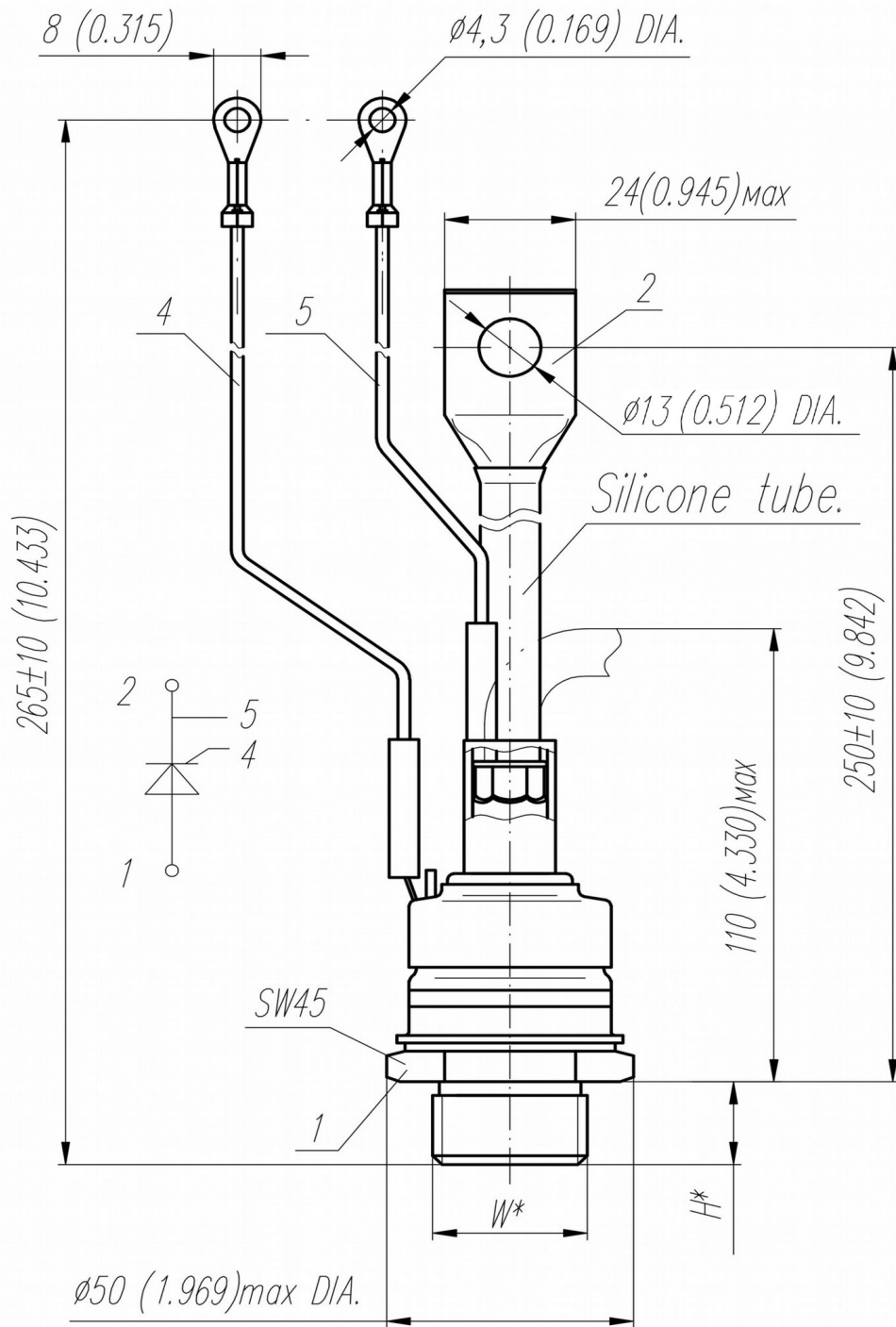

Type of screw	W	H
Metric Screw Type C	M24x1,5 – 8g	19
Metric Screw Type B (upon request)	M20x1,5 – 8g	15

Polarity	Example of code designation	Reference designation	Colors		
			Anode	Cathode	Gate
Anode to stud	T371-250-8		-	Red tube	White

All dimensions in millimeters (inches)

The information contained herein is confidential and protected by Copyright. In the interest of product improvement, Proton-Electrotex reserves the right to change data sheet without notice.

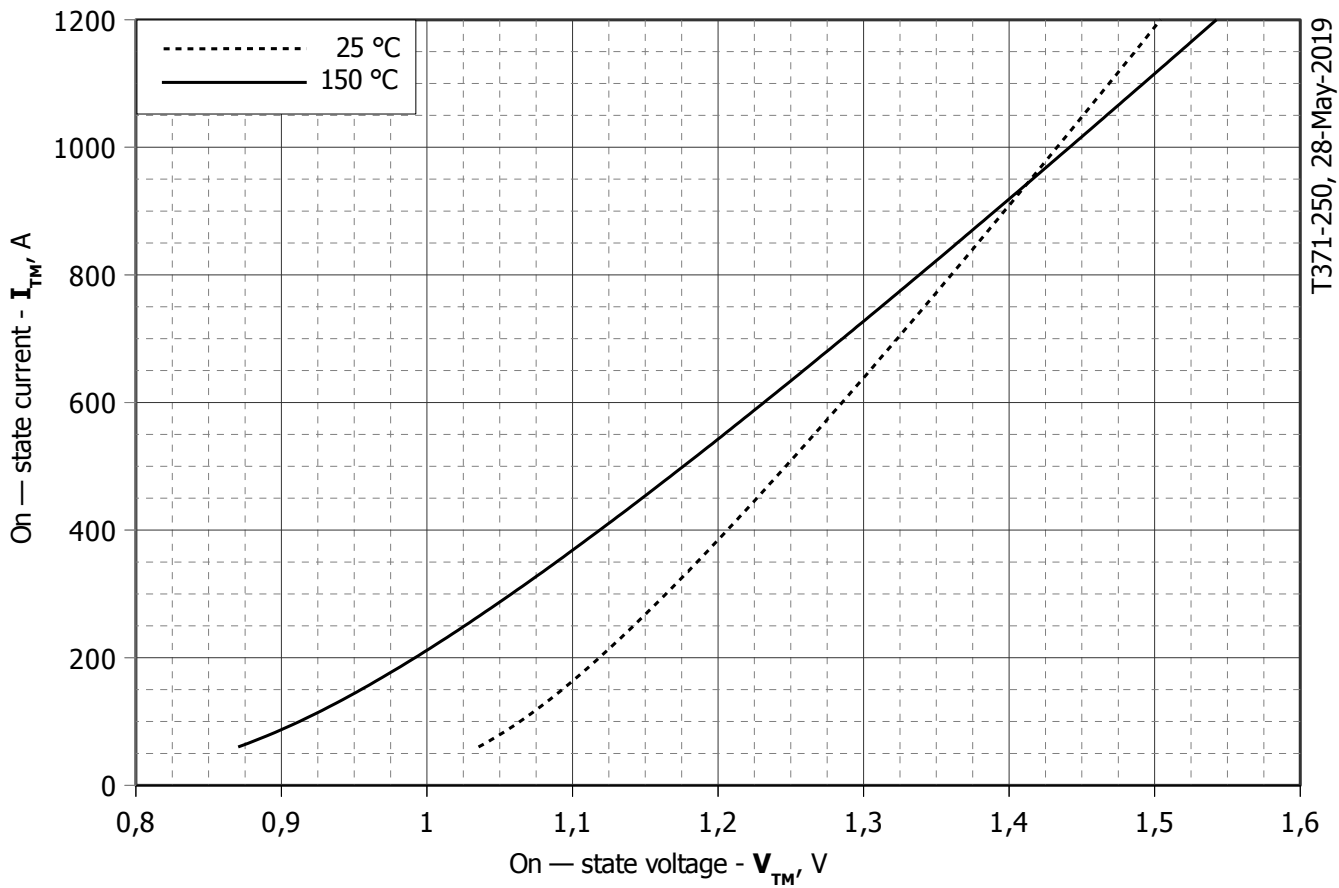

Fig 1 – On-state characteristics of Limit device

Analytical function for On-state characteristic:

$$V_T = A + B \cdot i_T + C \cdot \ln(i_T + 1) + D \cdot \sqrt{i_T}$$

	Coefficients for max curves	
	$T_j = 25^\circ\text{C}$	$T_j = T_{j\text{max}}$
A	0.89933000	0.66683000
B	0.00031406	0.00043689
C	0.02623400	0.03908100
D	0.00121040	0.00214470

On-state characteristic model (see Fig. 1)

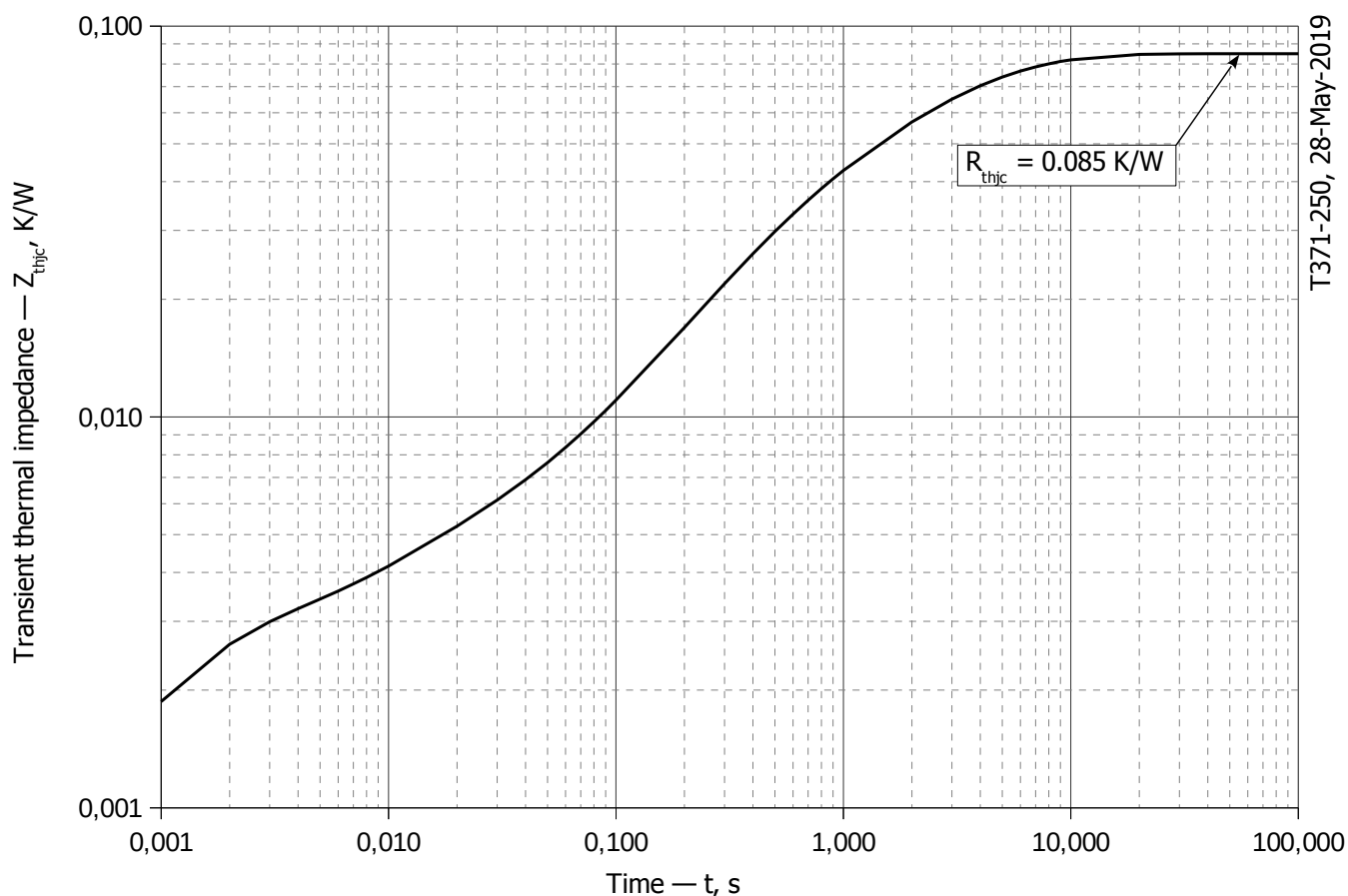

Fig 2 – Transient thermal impedance Z_{thjc} vs. time t

Analytical function for Transient thermal impedance junction to case Z_{thjc} for DC:

$$Z_{thjc} = \sum_{i=1}^n R_i \left(1 - e^{-\frac{t}{\tau_i}} \right)$$

Where $i = 1$ to n , n is the number of terms in the series.

t = Duration of heating pulse in seconds.

Z_{thjc} = Thermal resistance at time t .

R_i = Amplitude of p_{th} term.

τ_i = Time constant of r_{th} term.

DC

i	1	2	3	4	5	6
R_i K/W	0.023357	0.02733	0.01495	0.001445	0.002488	0.01543
τ_i s	4.627	2.249	0.3406	0.01043	0.0009112	0.9081

Transient thermal impedance junction to case Z_{thjc} model (see Fig. 2)

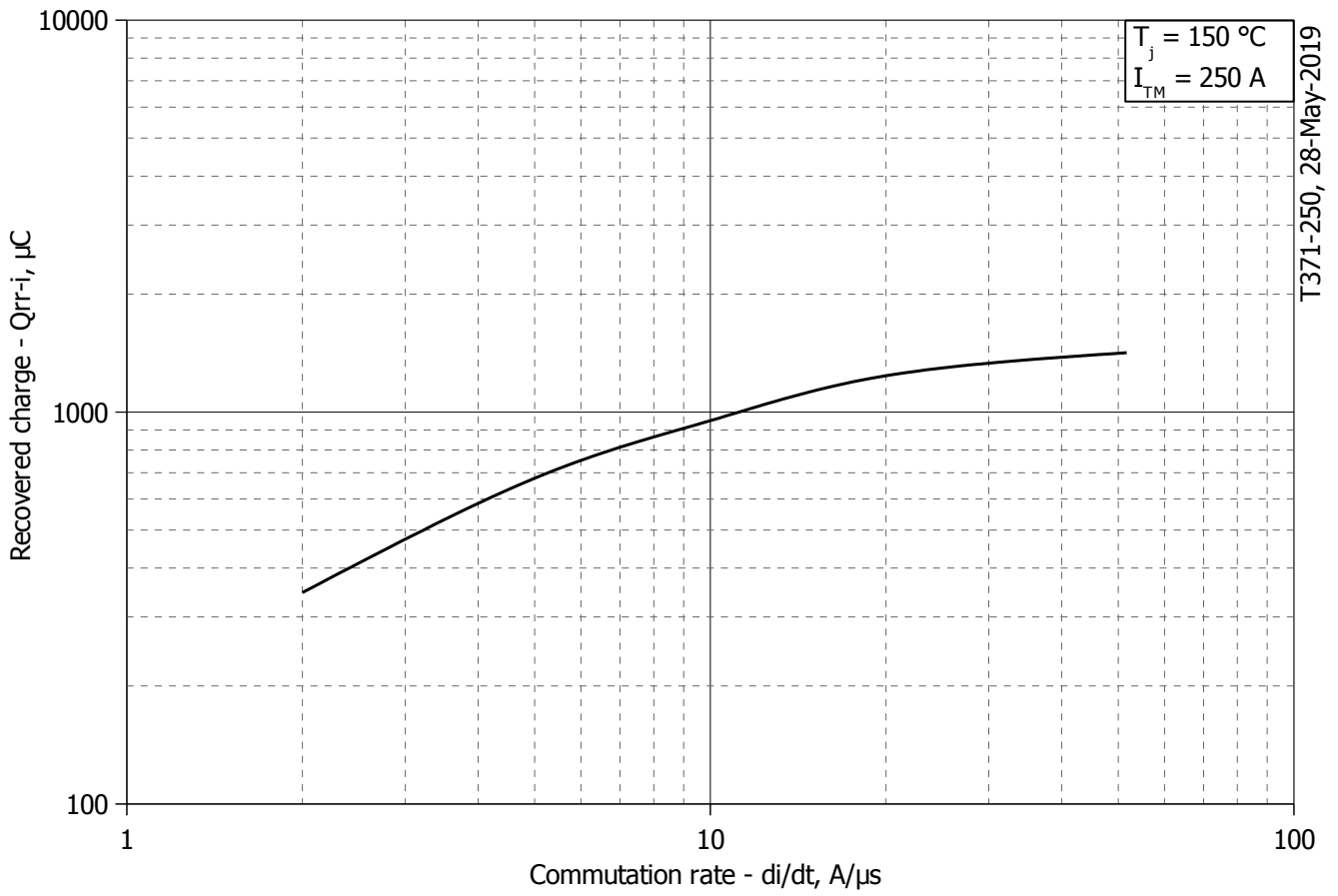

Fig 3 – Maximum recovered charge Q_{rr-i} (integral) vs. commutation rate di_R/dt

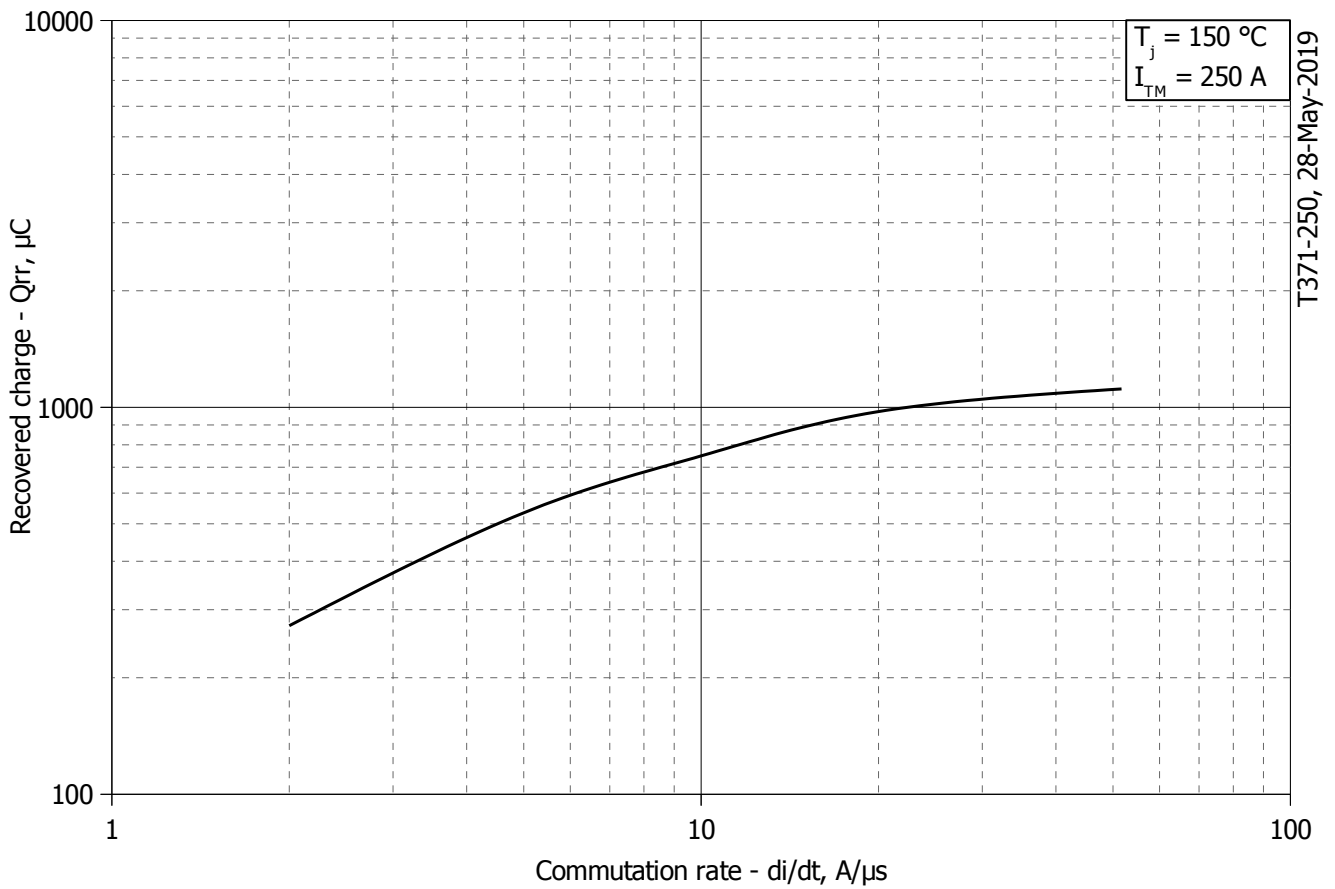

Fig 4 – Maximum recovered charge Q_{rr} vs. commutation rate di_R/dt (25% chord)

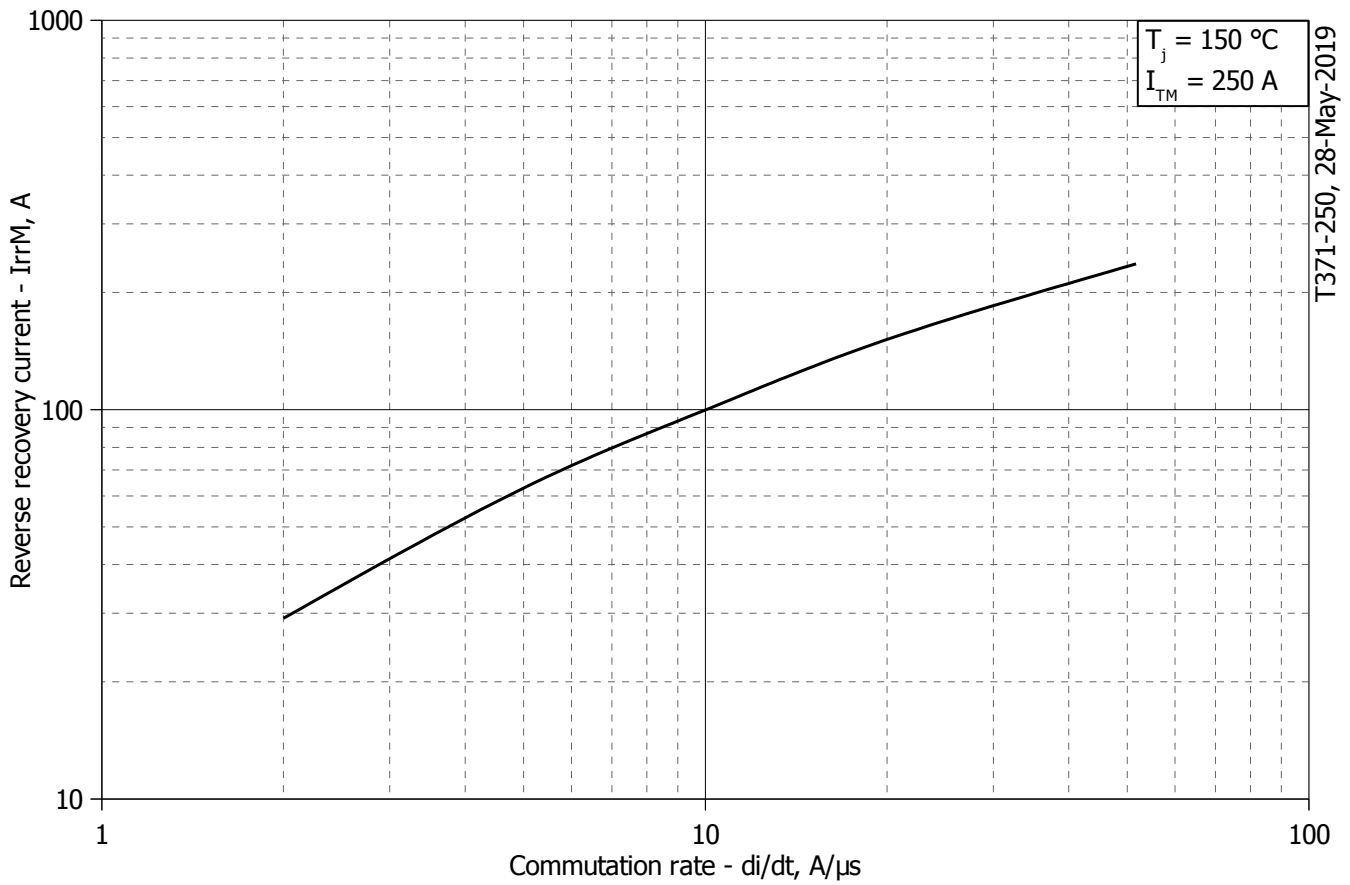

Fig 5 – Maximum reverse recovery current I_{rrM} vs. commutation rate di_R/dt

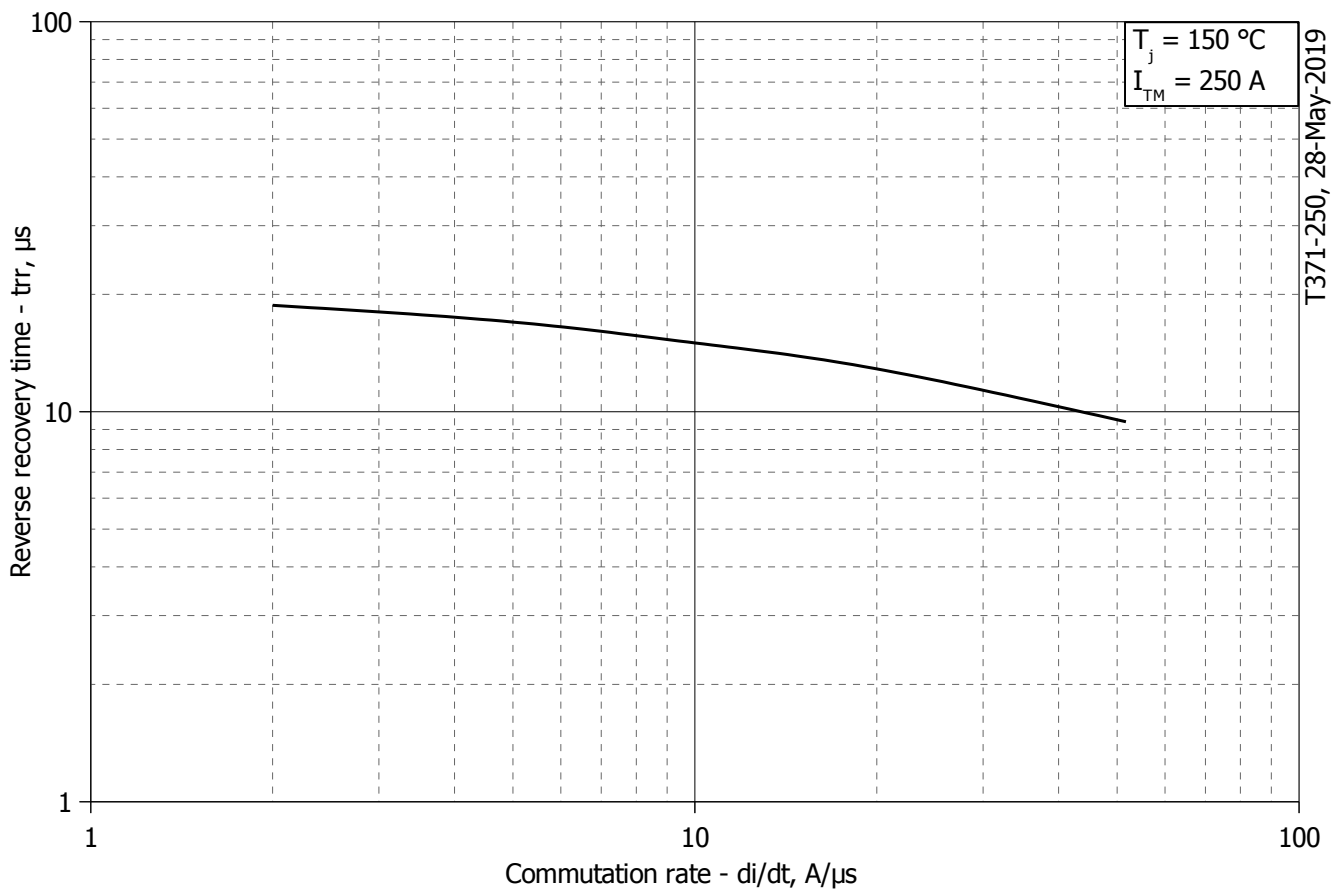

Fig 6 – Maximum recovery time t_{rr} vs. commutation rate di_R/dt (25% chord)

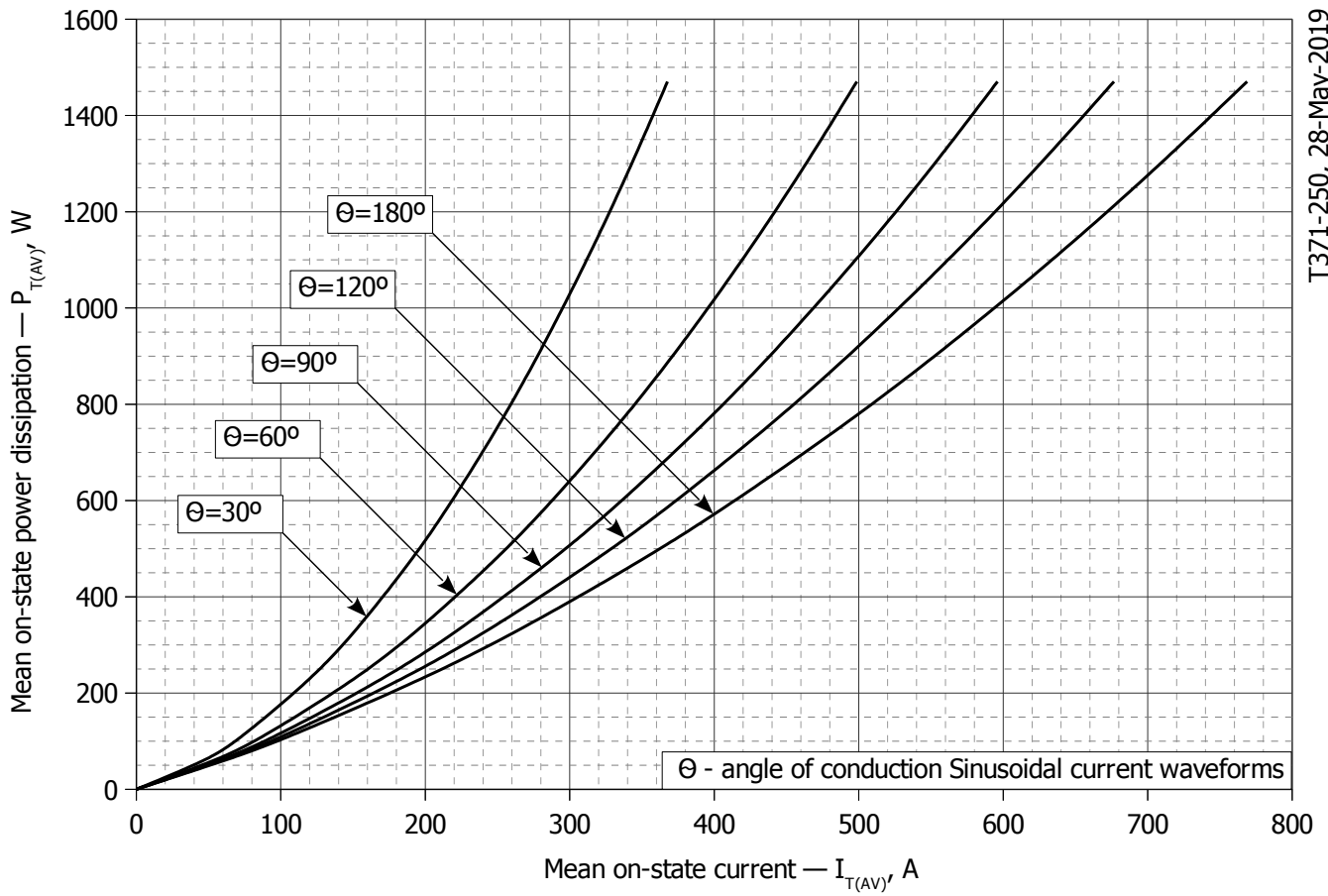

Fig. 7 - Mean on-state power dissipation P_{TAV} vs. mean on-state current I_{TAV} for sinusoidal current waveforms at different conduction angles ($f=50\text{Hz}$, DSC)

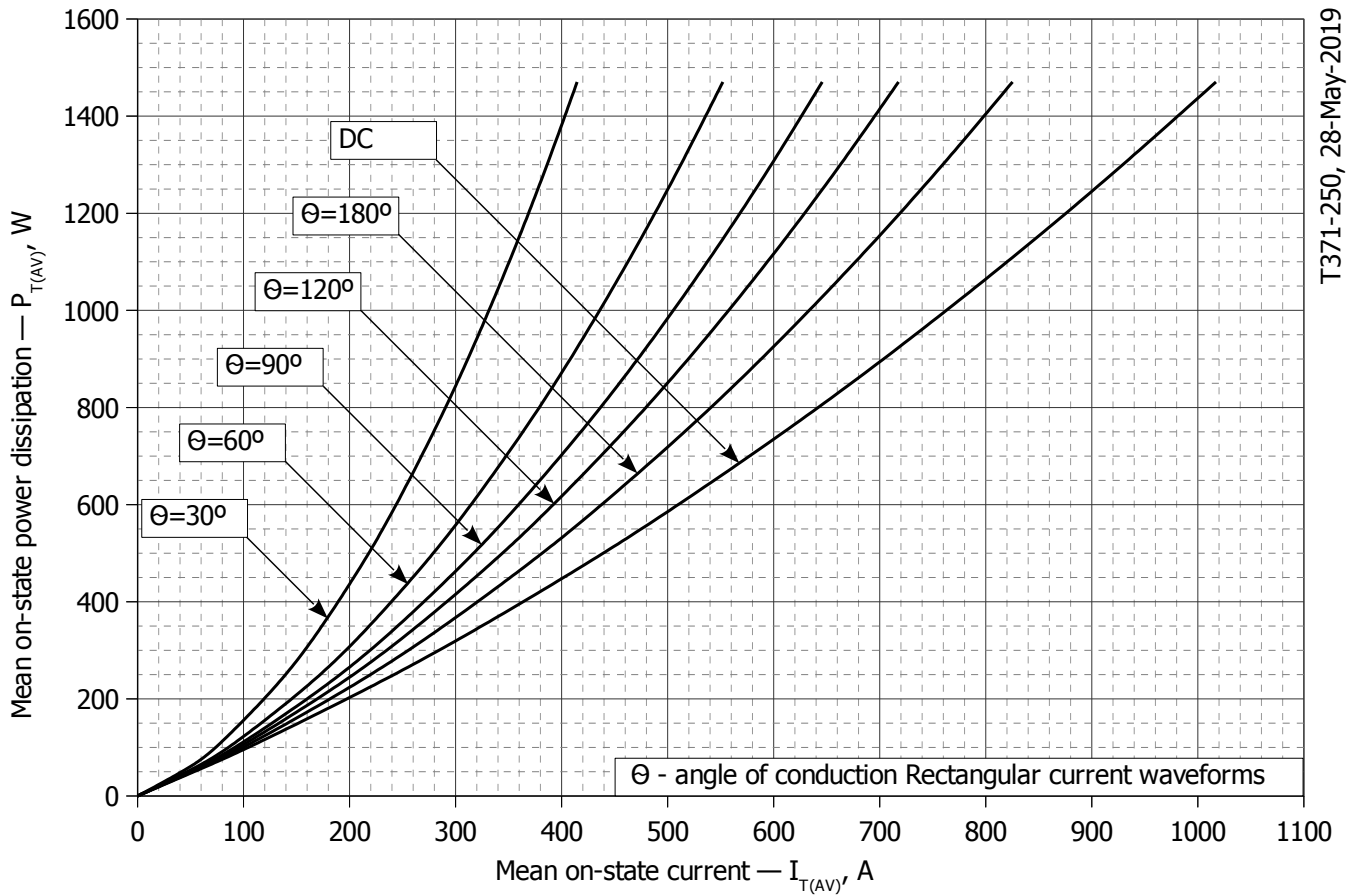

Fig. 8 - Mean on-state power dissipation P_{TAV} vs. mean on-state current I_{TAV} for rectangular current waveforms at different conduction angles and for DC ($f=50\text{Hz}$, DSC)

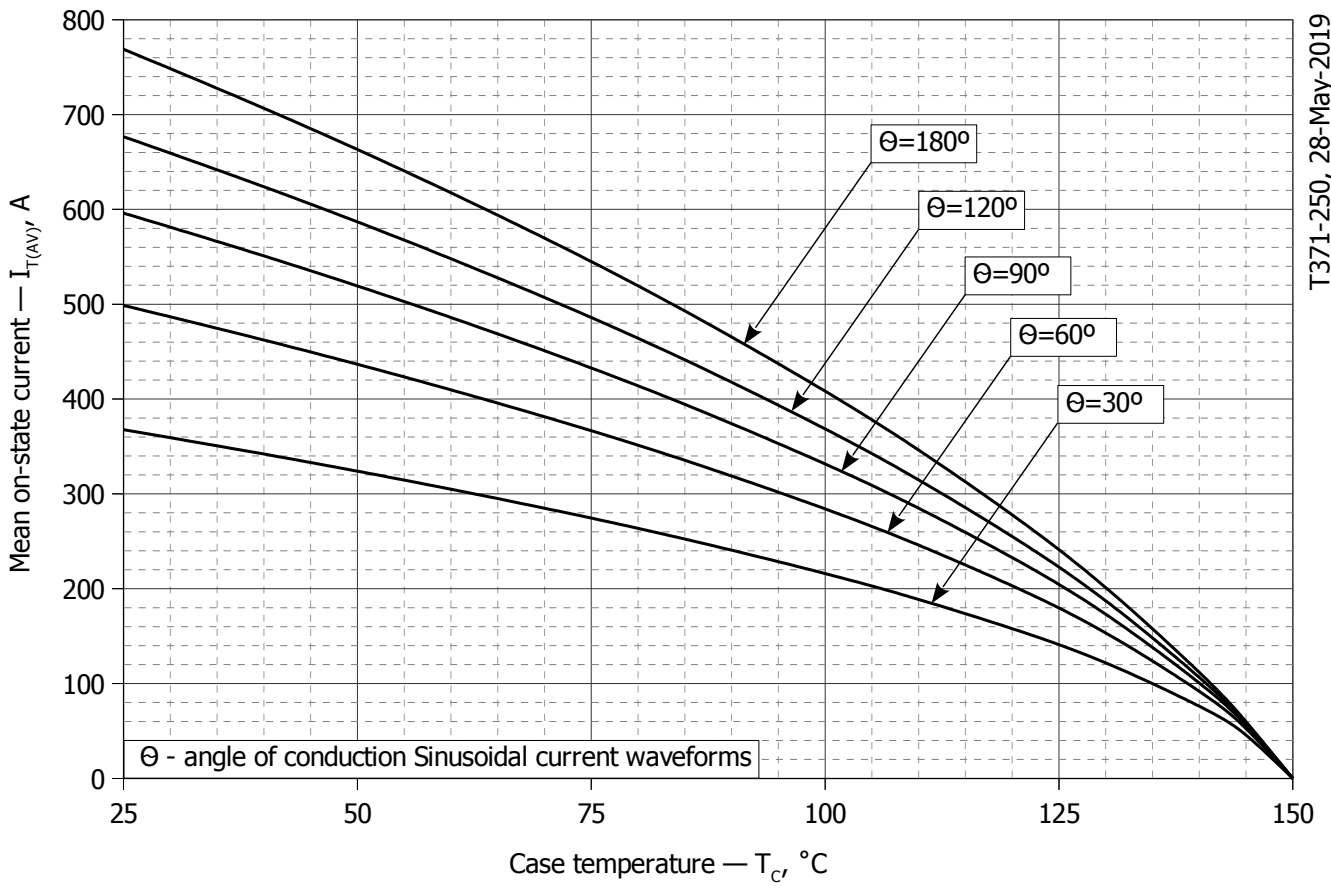

Fig. 9 – Mean on-state current I_{TAV} vs. case temperature T_c for sinusoidal current waveforms at different conduction angles ($f=50\text{Hz}$, DSC)

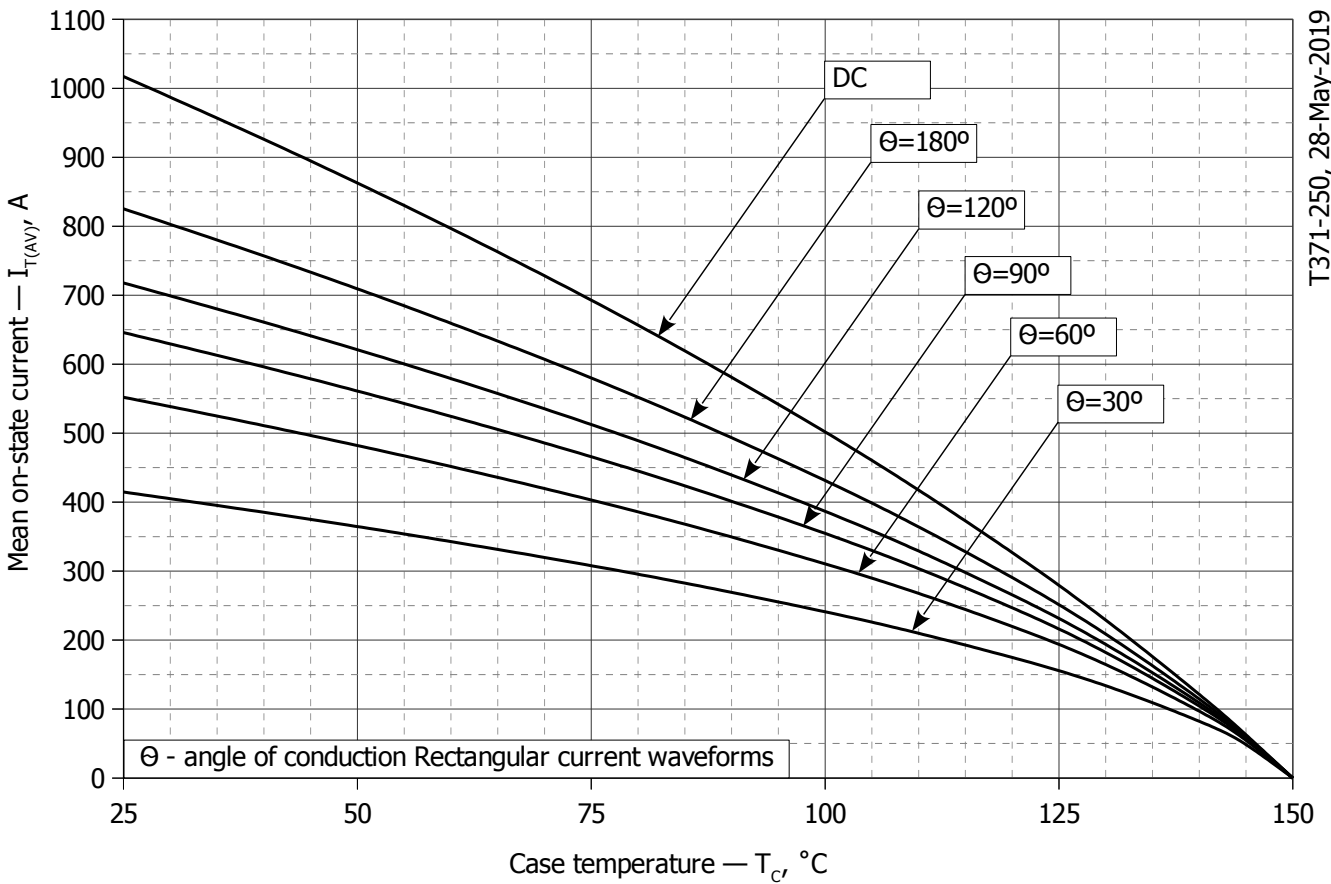

Fig. 10 - Mean on-state current I_{TAV} vs. case temperature T_c for rectangular current waveforms at different conduction angles and for DC ($f=50\text{Hz}$, DSC)

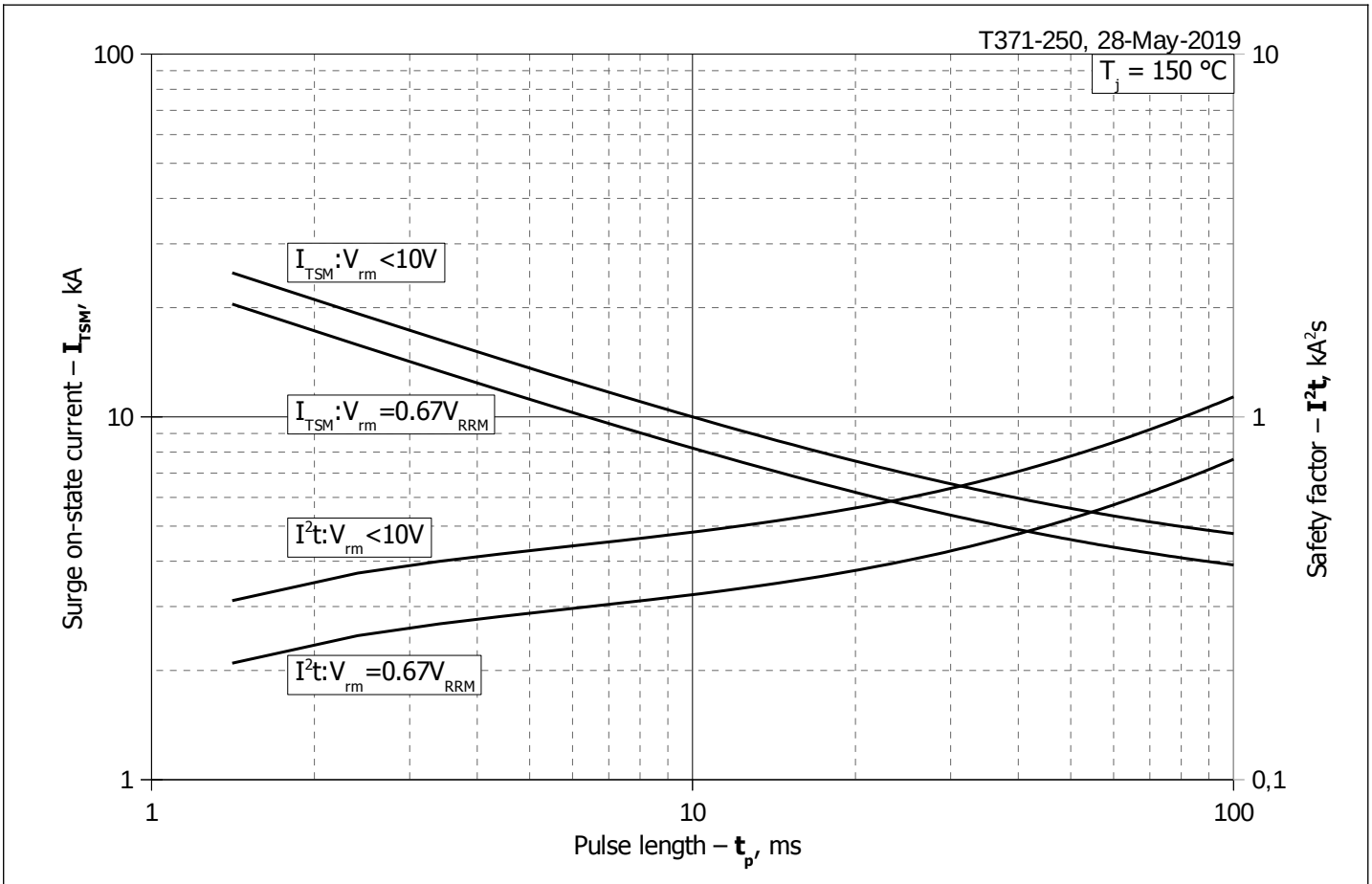

Fig. 11 – Maximum surge on-state current I_{TSM} and safety factor I^2t vs. pulse length t_p

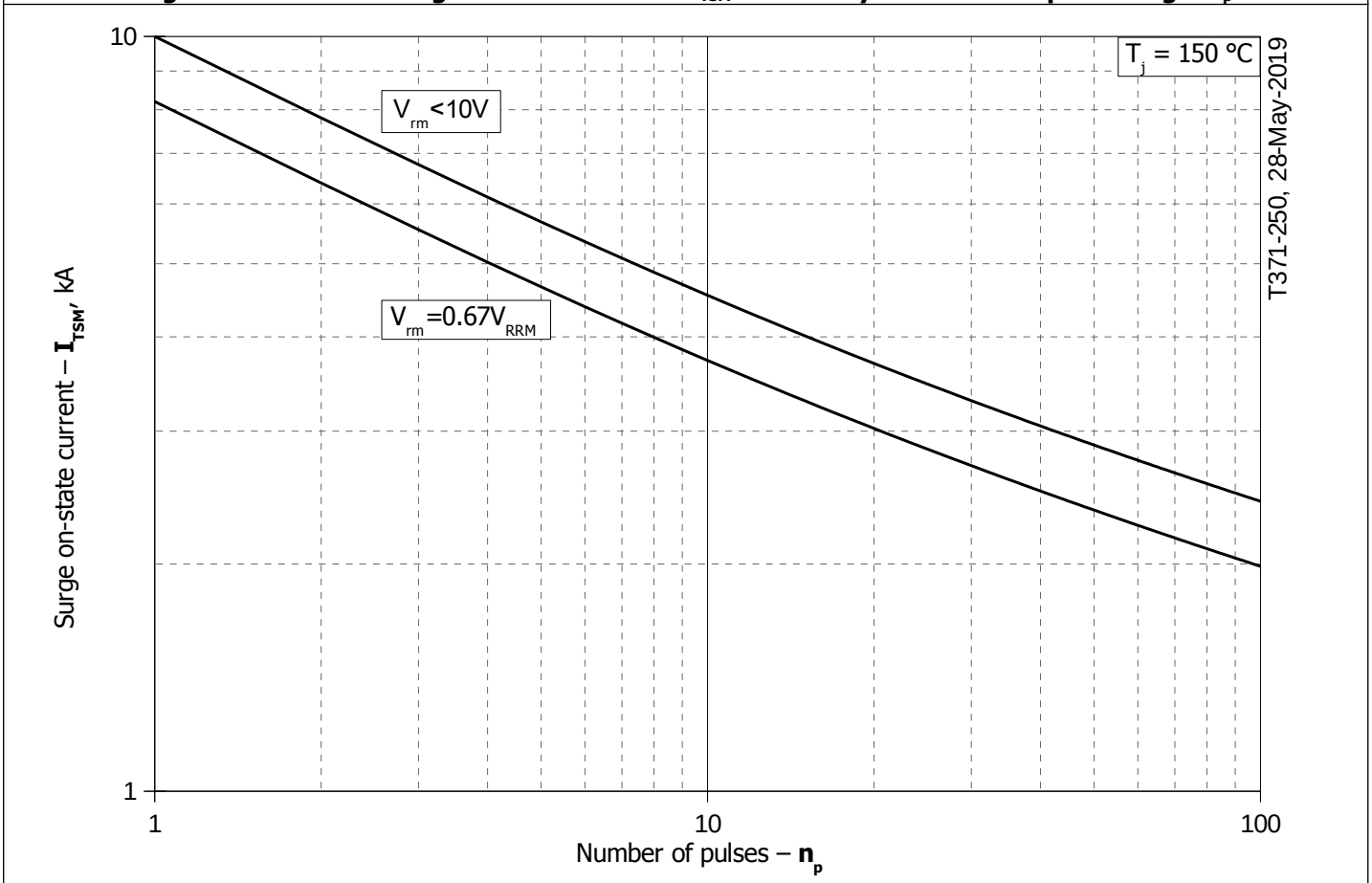

Fig. 12 - Maximum surge on-state current I_{TSM} vs. number of pulses n_p