



High power cycling capability
Low on-state and switching losses
Designed for traction and industrial applications

Phase Control Thyristor Type T353-1000-28

| | | | | | |
|-----------------------------------|-----------|------|-----------------------|------|------|
| Mean on-state current | I_{TAV} | | 1000 A | | |
| Repetitive peak off-state voltage | V_{DRM} | | 2000 ÷ 2800 V | | |
| Repetitive peak reverse voltage | V_{RRM} | | | | |
| Turn-off time | t_q | | 320, 400, 500 μ s | | |
| V_{DRM}, V_{RRM}, V | 2000 | 2200 | 2400 | 2600 | 2800 |
| Voltage code | 20 | 22 | 24 | 26 | 28 |
| $T_j, ^\circ C$ | -60 ÷ 125 | | | | |

MAXIMUM ALLOWABLE RATINGS

| Symbols and parameters | | Units | Values | Test conditions |
|------------------------|--|-------------------|--|---|
| ON-STATE | | | | |
| I_{TAV} | Mean on-state current | A | 1000 1225 | $T_c=95^\circ C$, Double side cooled $T_c=85^\circ C$, Double side cooled 180° half-sine wave; 50 Hz |
| I_{TRMS} | RMS on-state current | A | 1570 | $T_c=95^\circ C$, Double side cooled 180° half-sine wave; 50 Hz |
| I_{TSM} | Surge on-state current | kA | 23.0 26.0 | $T_j=T_{j\ max}$ $T_j=25^\circ C$ 180° half-sine wave; $t_p=10\ ms$; single pulse; $V_D=V_R=0\ V$; Gate pulse: $I_G=2\ A$; $t_{GP}=50\ \mu s$; $di_G/dt \geq 1\ A/\mu s$ |
| | | | 24.0 28.0 | $T_j=T_{j\ max}$ $T_j=25^\circ C$ 180° half-sine wave; $t_p=8.3\ ms$; single pulse; $V_D=V_R=0\ V$; Gate pulse: $I_G=2\ A$; $t_{GP}=50\ \mu s$; $di_G/dt \geq 1\ A/\mu s$ |
| I^2t | Safety factor | $A^2s \cdot 10^3$ | 2600 3300 | $T_j=T_{j\ max}$ $T_j=25^\circ C$ 180° half-sine wave; $t_p=10\ ms$; single pulse; $V_D=V_R=0\ V$; Gate pulse: $I_G=2\ A$; $t_{GP}=50\ \mu s$; $di_G/dt \geq 1\ A/\mu s$ |
| | | | 2300 3200 | $T_j=T_{j\ max}$ $T_j=25^\circ C$ 180° half-sine wave; $t_p=8.3\ ms$; single pulse; $V_D=V_R=0\ V$; Gate pulse: $I_G=2\ A$; $t_{GP}=50\ \mu s$; $di_G/dt \geq 1\ A/\mu s$ |
| BLOCKING | | | | |
| V_{DRM}, V_{RRM} | Repetitive peak off-state and Repetitive peak reverse voltages | V | 2000 ÷ 2800 | $T_{j\ min} < T_j < T_{j\ max}$; 180° half-sine wave; 50 Hz; Gate open |
| V_{DSM}, V_{RSM} | Non-repetitive peak off-state and Non-repetitive peak reverse voltages | V | 2100 ÷ 2900 | $T_{j\ min} < T_j < T_{j\ max}$; 180° half-sine wave; single pulse; Gate open |
| V_D, V_R | Direct off-state and Direct reverse voltages | V | $0.6 \cdot V_{DRM}$ $0.6 \cdot V_{RRM}$ | $T_j = T_{j\ max}$; Gate open |

| TRIGGERING | | | | |
|--------------------|---|------------------|------------------|---|
| I_{FGM} | Peak forward gate current | A | 8 | $T_j = T_{j\ max}$ |
| V_{RGM} | Peak reverse gate voltage | V | 5 | |
| P_G | Gate power dissipation | W | 4 | $T_j = T_{j\ max}$ for DC gate current |
| SWITCHING | | | | |
| $(di_T/dt)_{crit}$ | Critical rate of rise of on-state current non-repetitive (f=1 Hz) | A/ μ s | 2000 | $T_j = T_{j\ max}$; $V_D = 0.67 \cdot V_{DRM}$; $I_{TM} = 4000$ A; Gate pulse: $I_G = 2$ A; $t_{GP} = 50$ μ s; $di_G/dt \geq 2$ A/ μ s |
| THERMAL | | | | |
| T_{stg} | Storage temperature | $^{\circ}$ C | -60 \div 50 | |
| T_j | Operating junction temperature | $^{\circ}$ C | -60 \div 125 | |
| MECHANICAL | | | | |
| F | Mounting force | kN | 24.0 \div 28.0 | |
| a | Acceleration | m/s ² | 50 | Device clamped |

CHARACTERISTICS

| Symbols and parameters | | Units | Values | Conditions | |
|------------------------|---|------------|---------------------------------------|--|---|
| ON-STATE | | | | | |
| V_{TM} | Peak on-state voltage, max | V | 1.75 | $T_j = 25$ $^{\circ}$ C; $I_{TM} = 3140$ A | |
| $V_{T(TO)}$ | On-state threshold voltage, max | V | 0.928 | $T_j = T_{j\ max}$; | |
| r_T | On-state slope resistance, max | m Ω | 0.295 | $0.5 \pi I_{TAV} < I_T < 1.5 \pi I_{TAV}$ | |
| I_L | Latching current, max | mA | 1500 | $T_j = 25$ $^{\circ}$ C; $V_D = 12$ V; Gate pulse: $I_G = 2$ A; $t_{GP} = 50$ μ s; $di_G/dt \geq 1$ A/ μ s | |
| I_H | Holding current, max | mA | 300 | $T_j = 25$ $^{\circ}$ C; $V_D = 12$ V; Gate open | |
| BLOCKING | | | | | |
| I_{DRM}, I_{RRM} | Repetitive peak off-state and Repetitive peak reverse currents, max | mA | 150 | $T_j = T_{j\ max}$; $V_D = V_{DRM}$; $V_R = V_{RRM}$ | |
| $(dv_D/dt)_{crit}$ | Critical rate of rise of off-state voltage ¹⁾ , min | V/ μ s | 200, 320, 500, 1000, 1600, 2000, 2500 | $T_j = T_{j\ max}$; $V_D = 0.67 \cdot V_{DRM}$; Gate open | |
| TRIGGERING | | | | | |
| V_{GT} | Gate trigger direct voltage, max | V | 3.00 2.50 1.50 | $T_j = T_{j\ min}$ $T_j = 25$ $^{\circ}$ C $T_j = T_{j\ max}$ | $V_D = 12$ V; $I_D = 3$ A; Direct gate current |
| I_{GT} | Gate trigger direct current, max | mA | 400 250 150 | $T_j = T_{j\ min}$ $T_j = 25$ $^{\circ}$ C $T_j = T_{j\ max}$ | |
| V_{GD} | Gate non-trigger direct voltage, min | V | 0.35 | $T_j = T_{j\ max}$; | |
| I_{GD} | Gate non-trigger direct current, min | mA | 45.00 | $V_D = 0.67 \cdot V_{DRM}$; Direct gate current | |
| SWITCHING | | | | | |
| t_{gd} | Delay time, max | μ s | 1.25 | $T_j = 25$ $^{\circ}$ C; $V_D = 1500$ V; $I_{TM} = I_{TAV}$; $di/dt = 200$ A/ μ s; | |
| t_{gt} | Turn-on time | μ s | 8.00 | Gate pulse: $I_G = 2$ A; $V_G = 20$ V; $t_{GP} = 50$ μ s; $di_G/dt = 2$ A/ μ s | |
| t_q | Turn-off time ²⁾ , max | μ s | 320, 400, 500 | $dv_D/dt = 50$ V/ μ s; $T_j = T_{j\ max}$; $I_{TM} = I_{TAV}$; $di_R/dt = -10$ A/ μ s; $V_R = 100$ V; $V_D = 0.67 \cdot V_{DRM}$ | |
| Q_{rr} | Total recovered charge, max | μ C | 3640 | $T_j = T_{j\ max}$; $I_{TM} = 1000$ A; | |
| t_{rr} | Reverse recovery time, max | μ s | 40 | $di_R/dt = -10$ A/ μ s; | |
| I_{rrM} | Peak reverse recovery current, max | A | 182 | $V_R = 100$ V | |

| THERMAL | | | | | |
|--------------|---|--------------|------------------|----------------|---------------------|
| R_{thjc} | Thermal resistance, junction to case, max | °C/W | 0.0180 | Direct current | Double side cooled |
| R_{thjc-A} | | | 0.0396 | | Anode side cooled |
| R_{thjc-K} | | | 0.0324 | | Cathode side cooled |
| R_{thck} | Thermal resistance, case to heatsink, max | °C/W | 0.0040 | Direct current | |
| MECHANICAL | | | | | |
| w | Weight, max | g | 510 | | |
| D_s | Surface creepage distance | mm (inch) | 30.38 (1.196) | | |
| D_a | Air strike distance | mm (inch) | 18.05 (0.710) | | |

| PART NUMBERING GUIDE | | | | | | | NOTES | | | | | | | |
|---|-----|------|----|----|----|---|---|-----|-----|-----|------|------|------|------|
| T | 353 | 1000 | 28 | A2 | K2 | N | 1) Critical rate of rise of off-state voltage | | | | | | | |
| 1 | 2 | 3 | 4 | 5 | 6 | 7 | Symbol of Group | | | | | | | |
| 1. Phase Control Thyristor | | | | | | | $(dv_D/dt)_{crit}$, V/ μ s | P2 | K2 | E2 | A2 | T1 | P1 | M1 |
| 2. Design version | | | | | | | | 200 | 320 | 500 | 1000 | 1600 | 2000 | 2500 |
| 3. Mean on-state current, A | | | | | | | 2) Turn-off time ($dv_D/dt=50$ V/ μ s) | | | | | | | |
| 4. Voltage code | | | | | | | Symbol of Group | | | | | | | |
| 5. Critical rate of rise of off-state voltage, V/ μ s | | | | | | | t_q , μ s | K2 | | H2 | | E2 | | |
| 6. Turn-off time ($dv_D/dt=50$ V/ μ s) | | | | | | | | 320 | | 400 | | 500 | | |
| 7. Ambient conditions: N – normal; T – tropical | | | | | | | | | | | | | | |

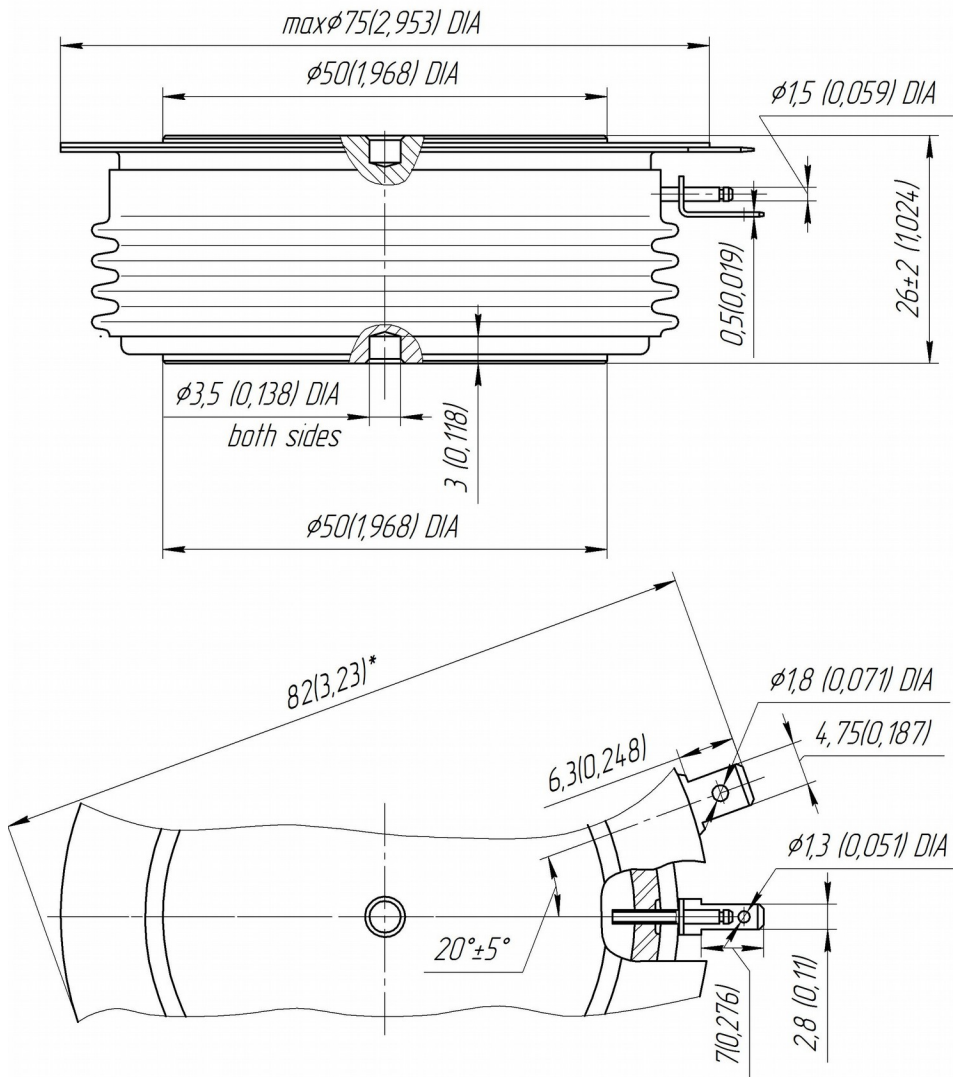

All dimensions in millimeters (inches)

The information contained herein is confidential and protected by Copyright.
 In the interest of product improvement, Proton-Electrotex reserves the right to change data sheet without notice.

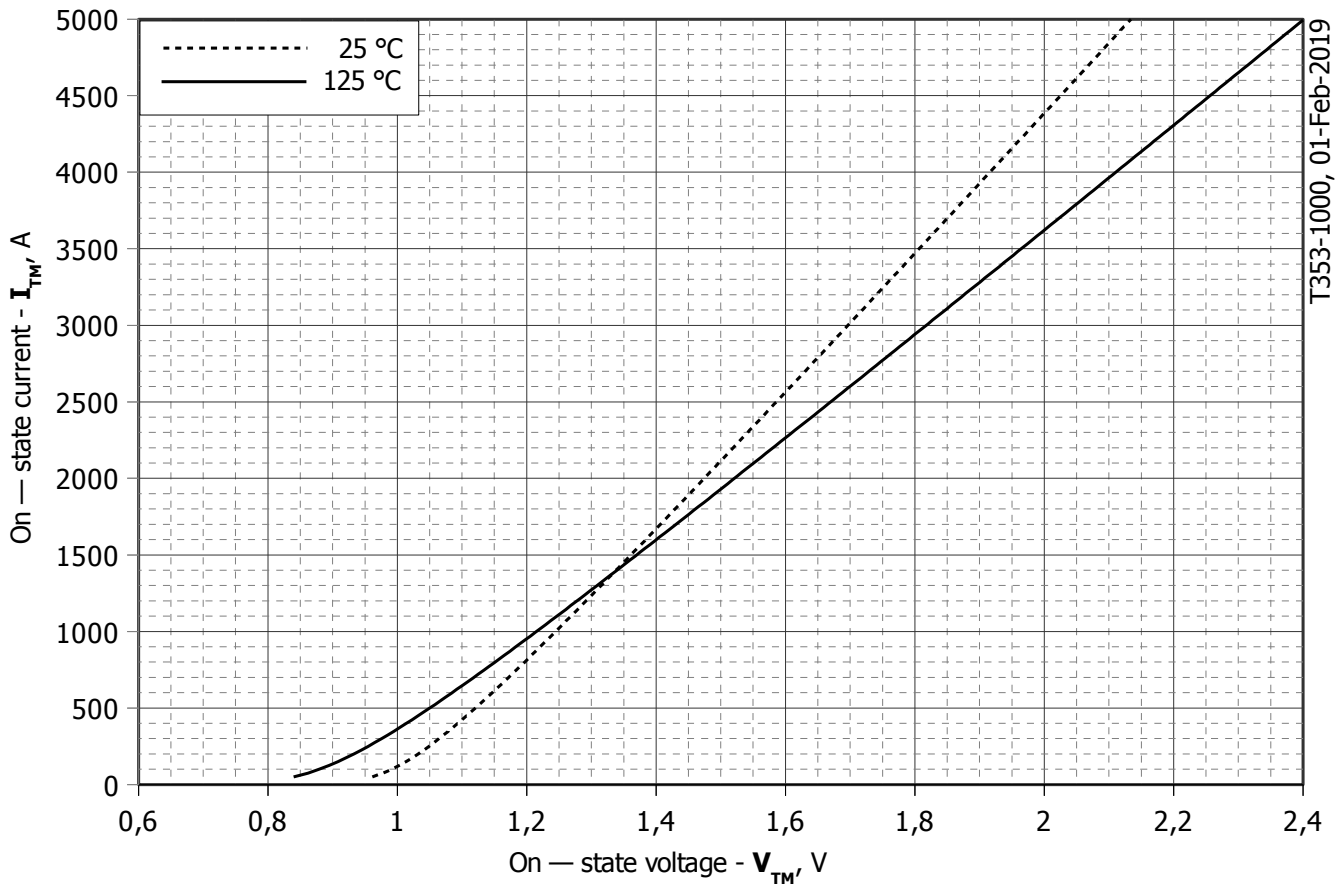

Fig 1 – On-state characteristics of Limit device

Analytical function for On-state characteristic:

$$V_T = A + B \cdot i_T + C \cdot \ln(i_T + 1) + D \cdot \sqrt{i_T}$$

| | Coefficients for max curves | |
|----------|-----------------------------|-------------------------|
| | $T_j = 25^\circ\text{C}$ | $T_j = T_{j\text{max}}$ |
| A | 0.83263000 | 0.67210000 |
| B | 0.00021494 | 0.00028757 |
| C | 0.03093000 | 0.04031000 |
| D | -0.00052016 | -0.00072940 |

On-state characteristic model (see Fig. 1)

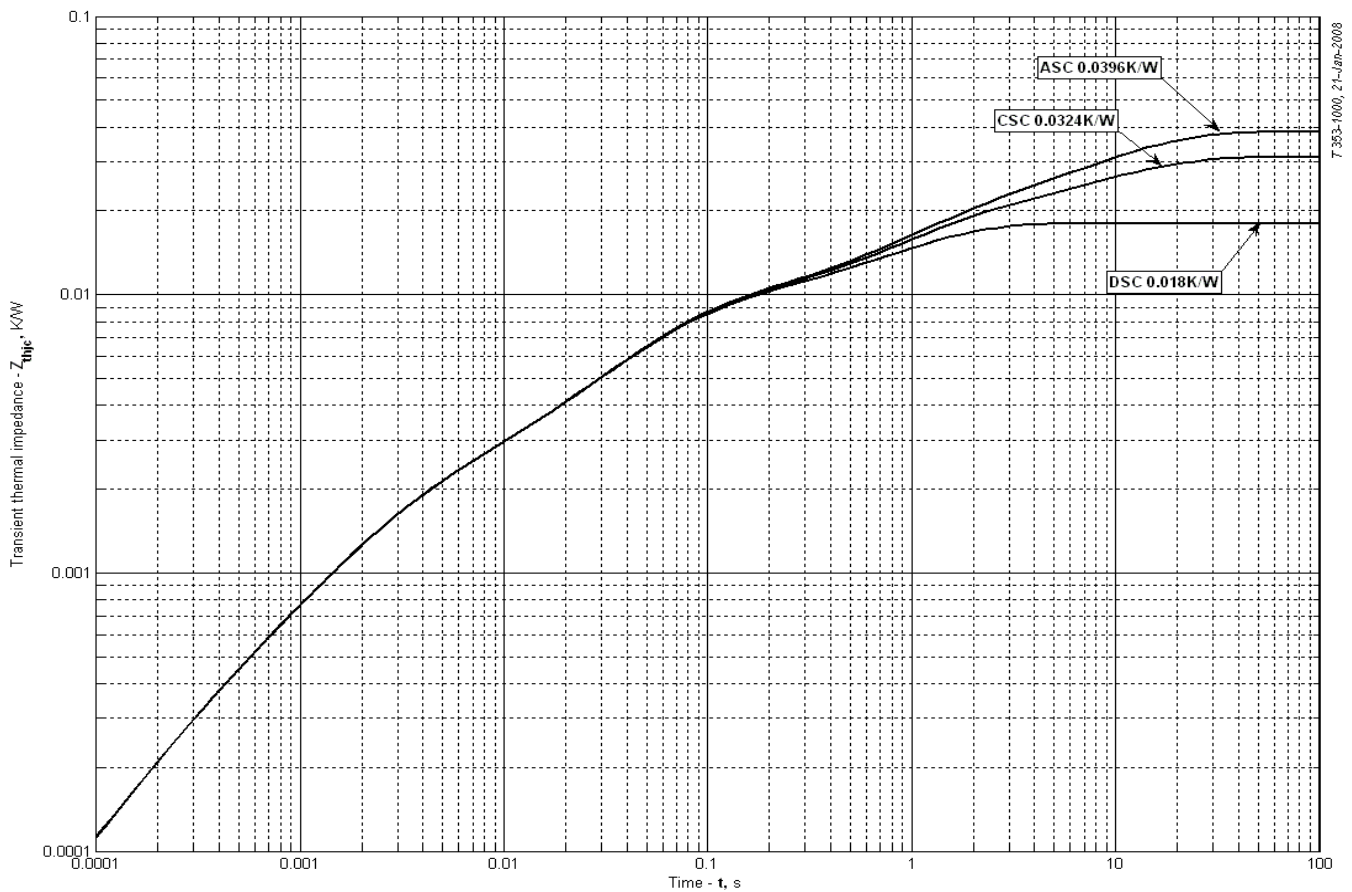

Fig 2 – Transient thermal impedance

Analytical function for Transient thermal impedance junction to case Z_{thjc} for DC:

$$Z_{thjc} = \sum_{i=1}^n R_i \left(1 - e^{-\frac{t}{\tau_i}} \right)$$

Where $i = 1$ to n , n is the number of terms in the series.

t = Duration of heating pulse in seconds.

Z_{thjc} = Thermal resistance at time t .

R_i = Amplitude of p_{th} term.

τ_i = Time constant of r_{th} term.

DC Double side cooled

| i | 1 | 2 | 3 | 4 | 5 | 6 |
|--------------|----------|----------|----------|----------|-----------|------------|
| R_i , K/W | 0.009241 | 0.006037 | 0.001231 | 0.001054 | 0.0003396 | 0.00009575 |
| τ_i , s | 0.9673 | 0.04967 | 0.002733 | 0.07734 | 0.001638 | 0.0002248 |

DC Cathode side cooled

| i | 1 | 2 | 3 | 4 | 5 | 6 |
|--------------|---------|----------|----------|----------|----------|-----------|
| R_i , K/W | 0.01318 | 0.009281 | 0.006055 | 0.001018 | 0.001535 | 0.0001182 |
| τ_i , s | 9.745 | 1.028 | 0.05591 | 0.03732 | 0.002468 | 0.0002687 |

DC Anode side cooled

| i | 1 | 2 | 3 | 4 | 5 | 6 |
|--------------|---------|----------|----------|-----------|----------|-----------|
| R_i , K/W | 0.02041 | 0.009325 | 0.006949 | 0.0001252 | 0.001516 | 0.0001119 |
| τ_i , s | 9.752 | 1.065 | 0.05344 | 0.01407 | 0.002421 | 0.0002554 |

Transient thermal impedance junction to case Z_{thjc} model (see Fig. 2)

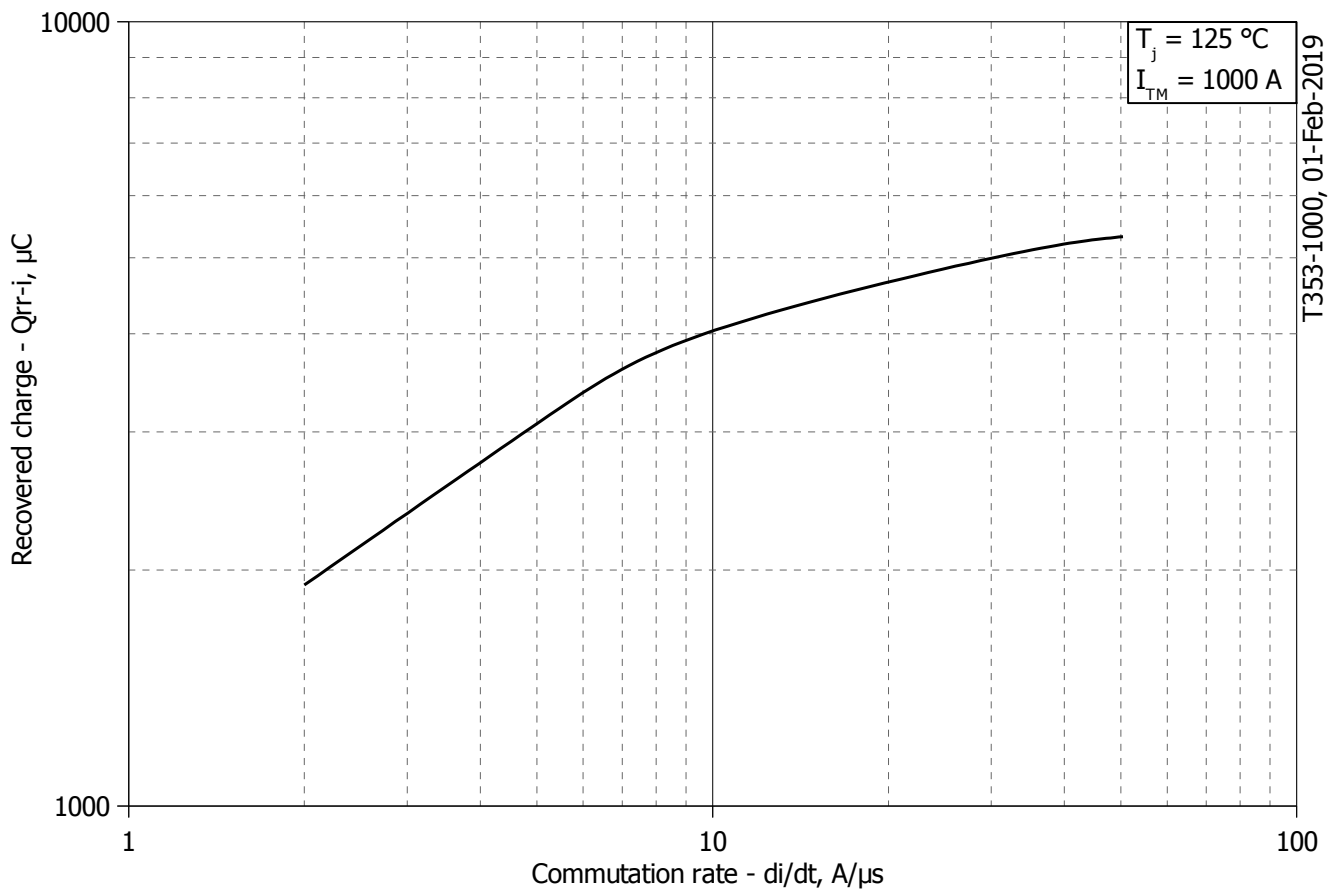

Fig 3 - Total recovered charge, Q_{rr-i} (integral)

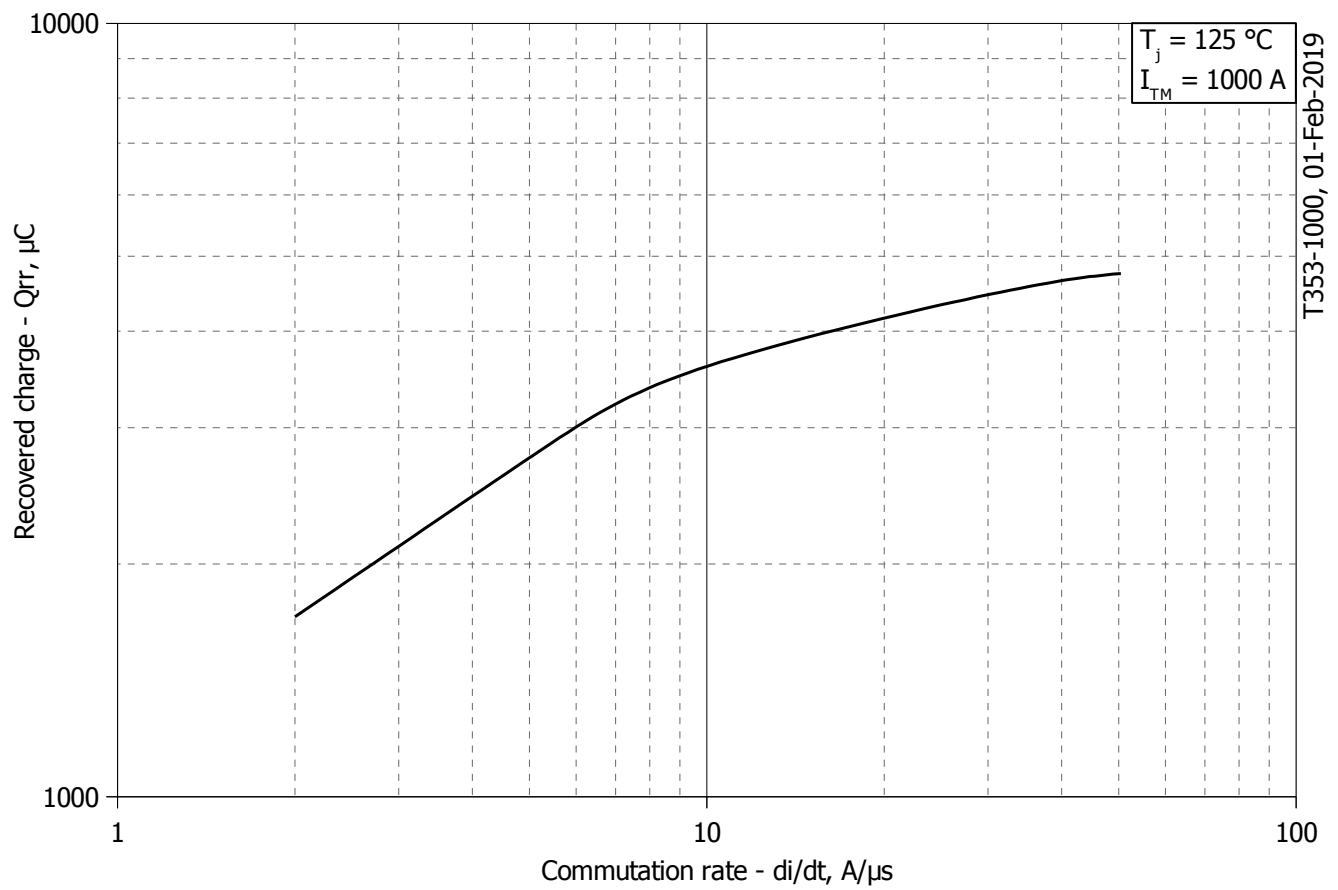

Fig 4 - Recovered charge, Q_{rr} (25% chord)

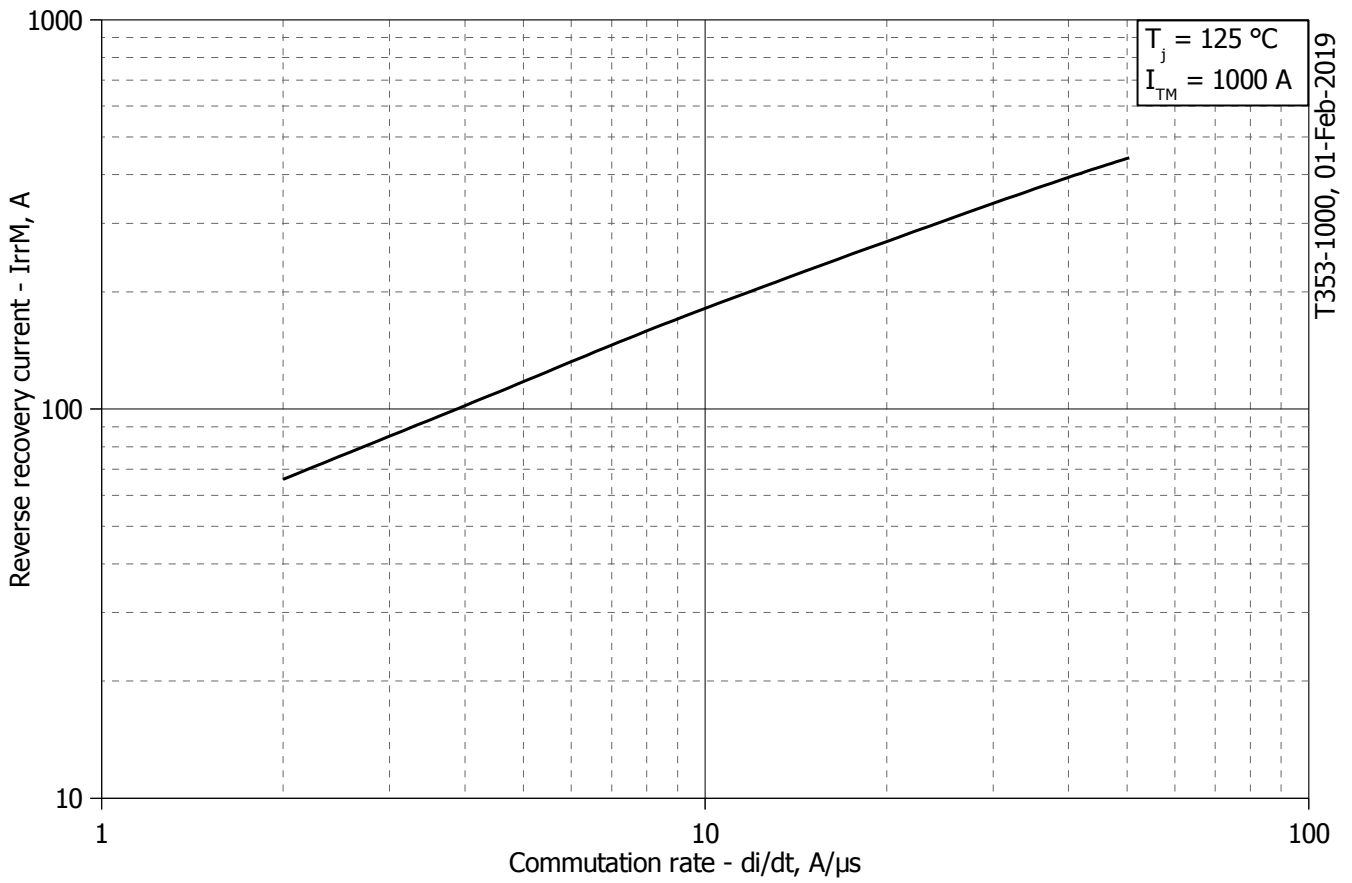

Fig 5 – Peak reverse recovery current, I_{rrM}

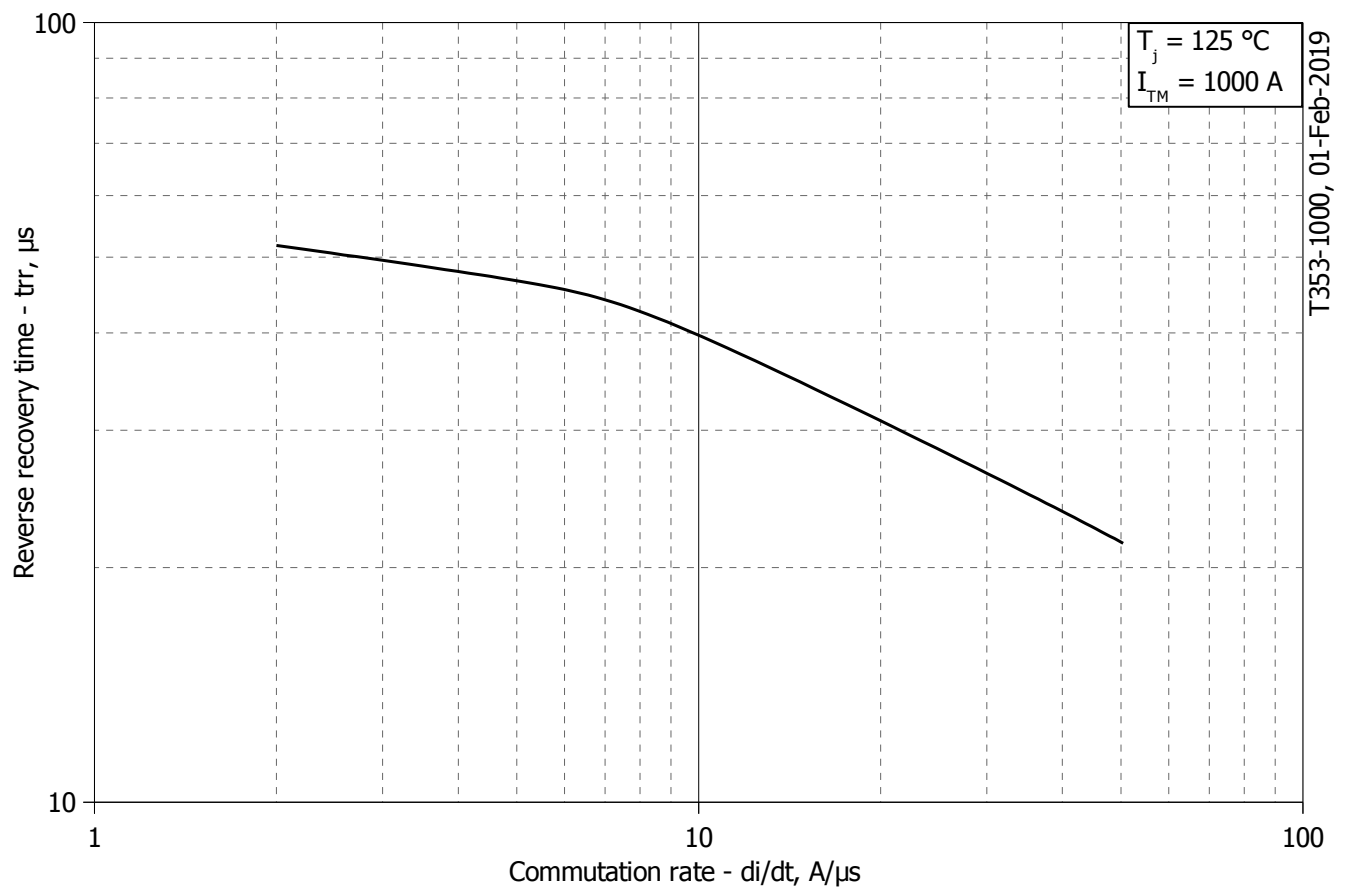
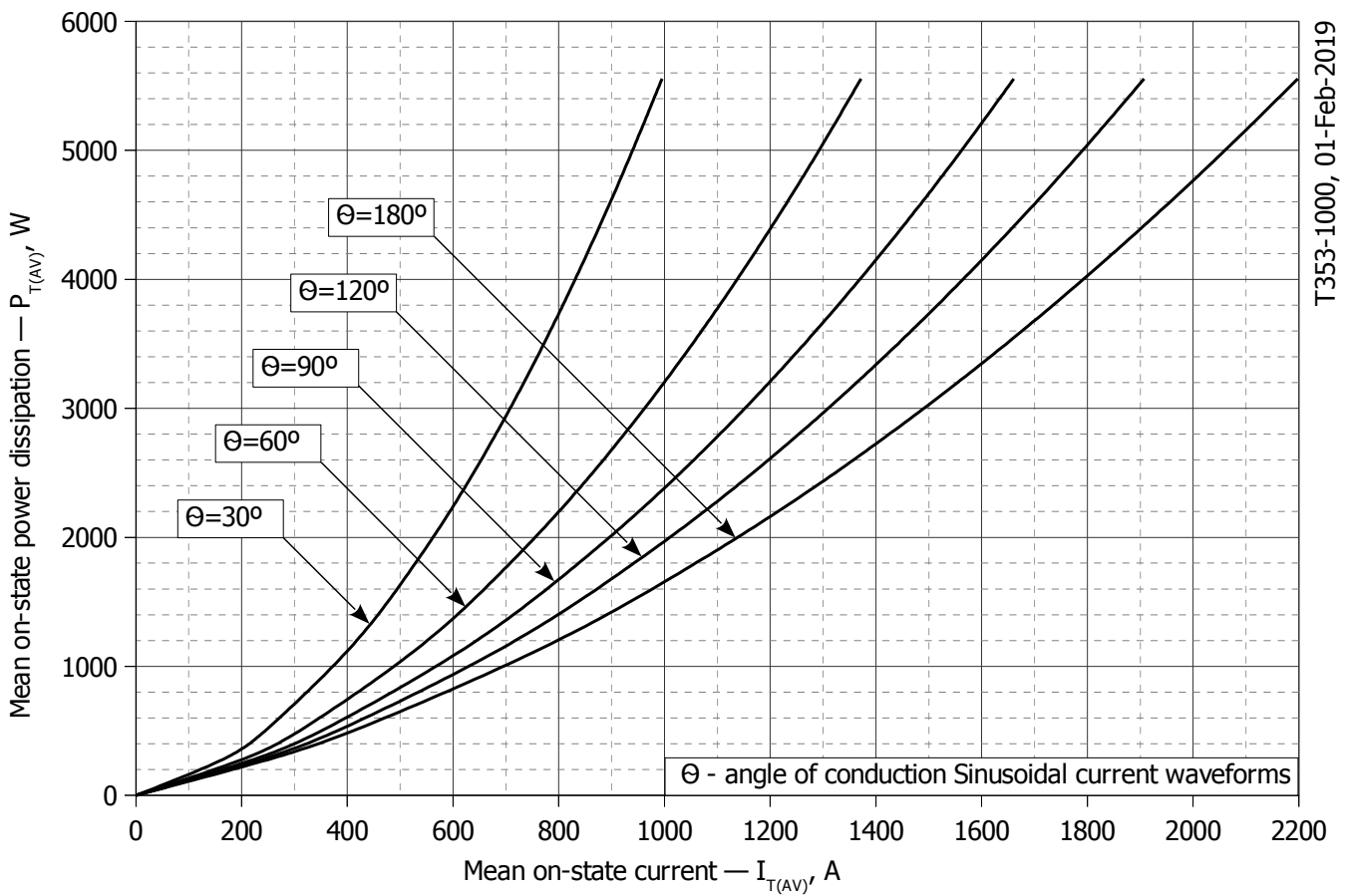
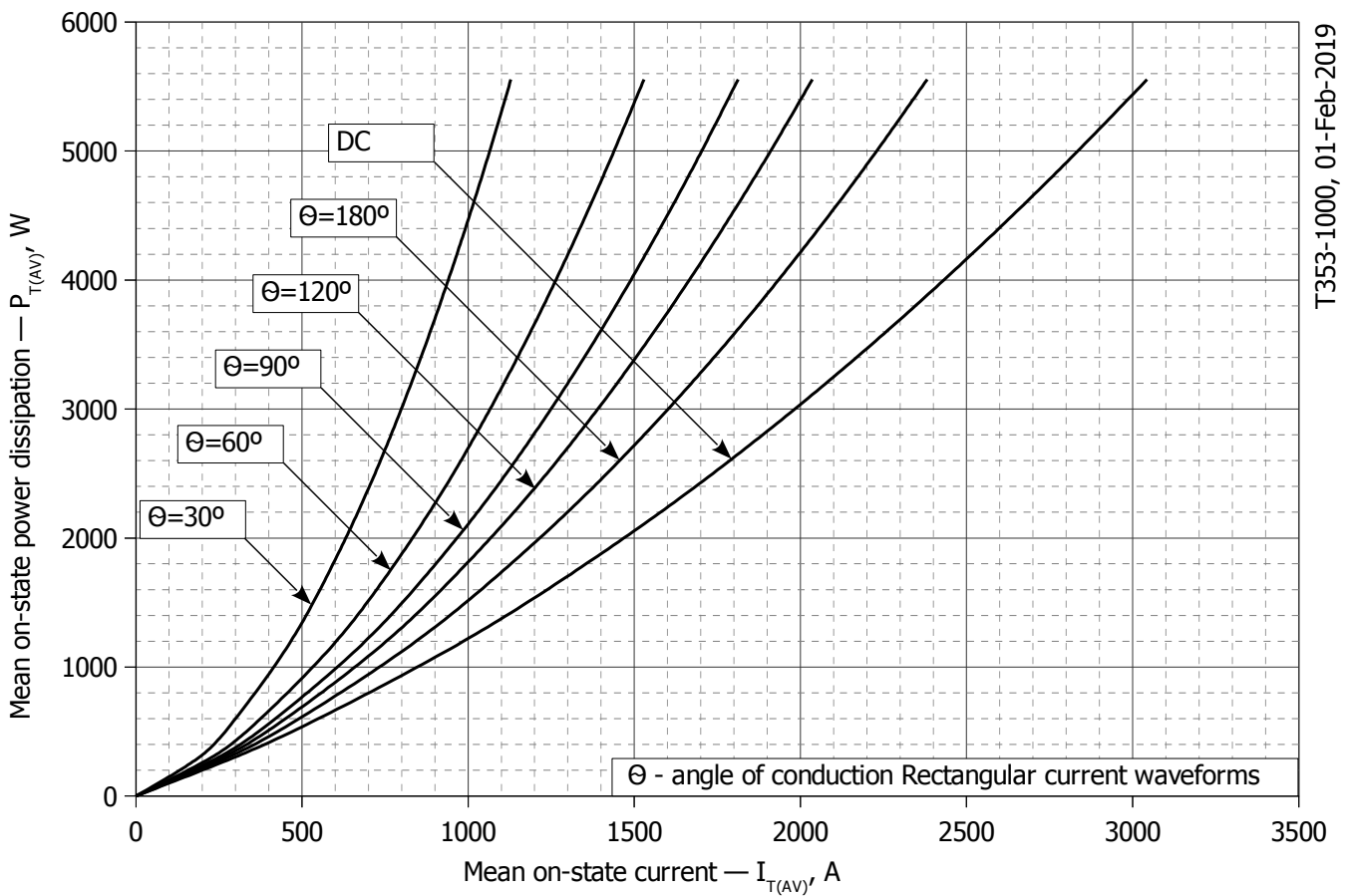

Fig 6 - Maximum recovery time, t_{rr} (25% chord)



T353-1000, 01-Feb-2019

Fig 9 – On-state power loss (sinusoidal current waveforms)



T353-1000, 01-Feb-2019

Fig 10 – On-state power loss (rectangular current waveforms)

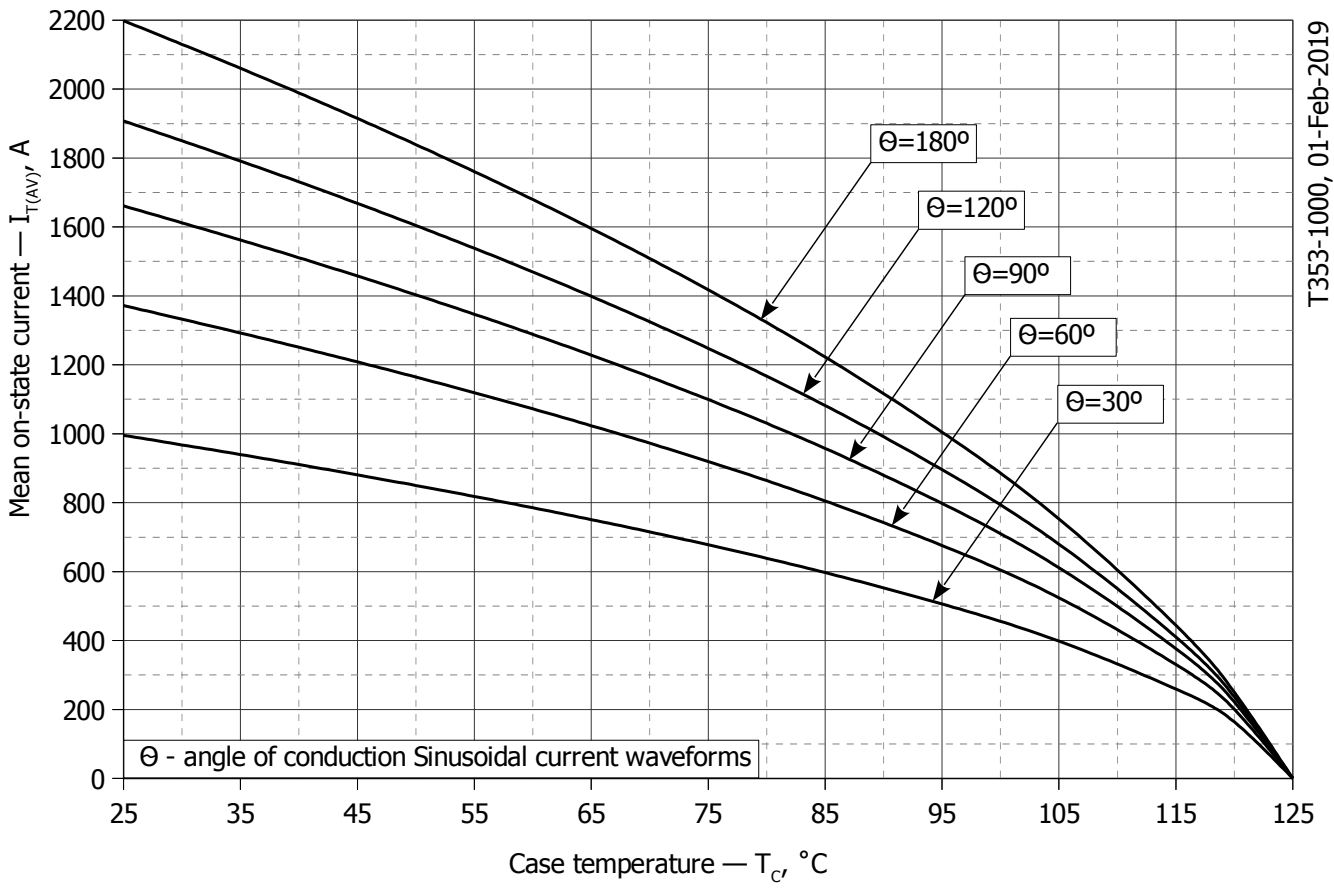

Fig 11 – Maximum case temperature DSC (sinusoidal current waveforms)

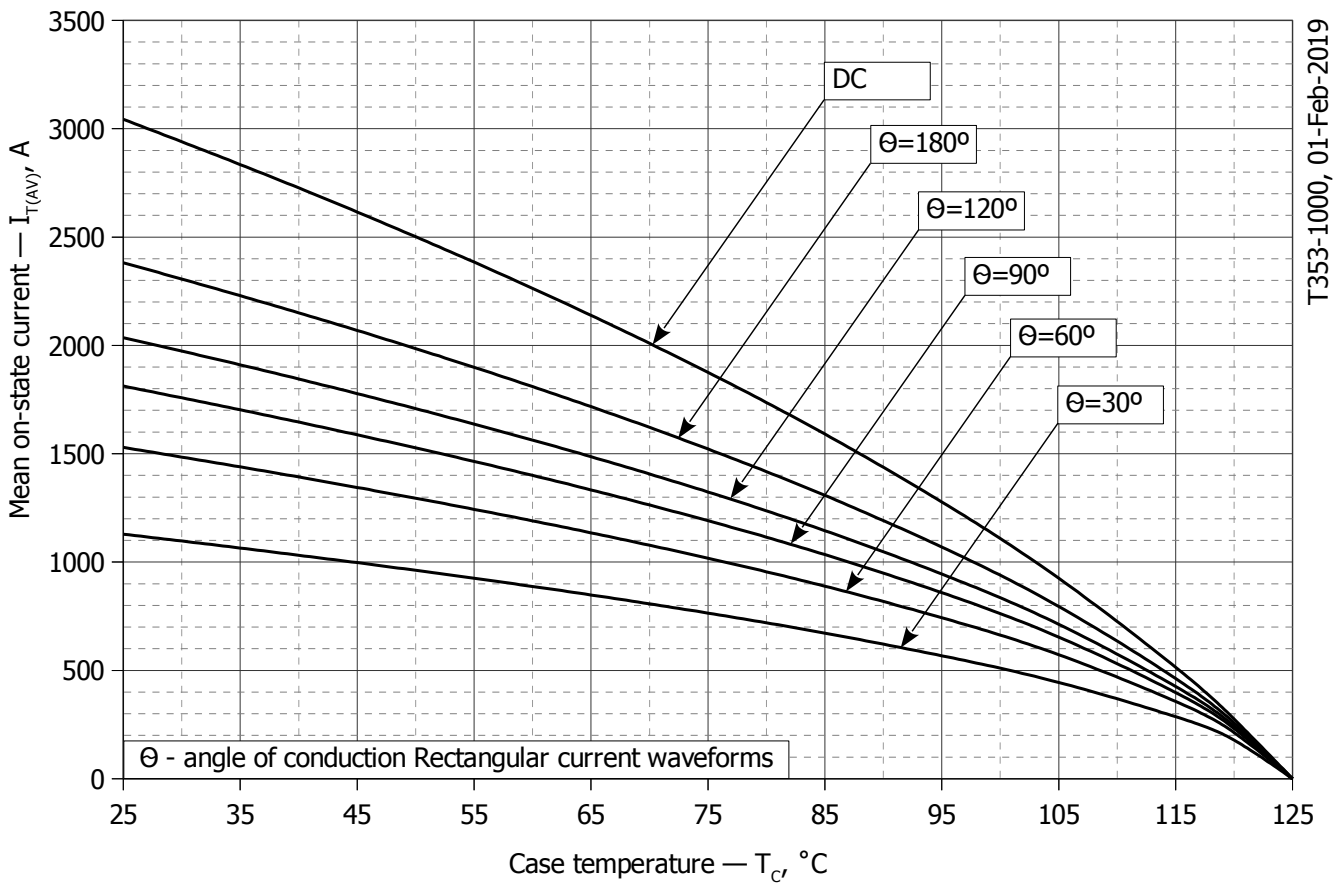

Fig 12 – Maximum case temperature DSC (rectangular current waveforms)

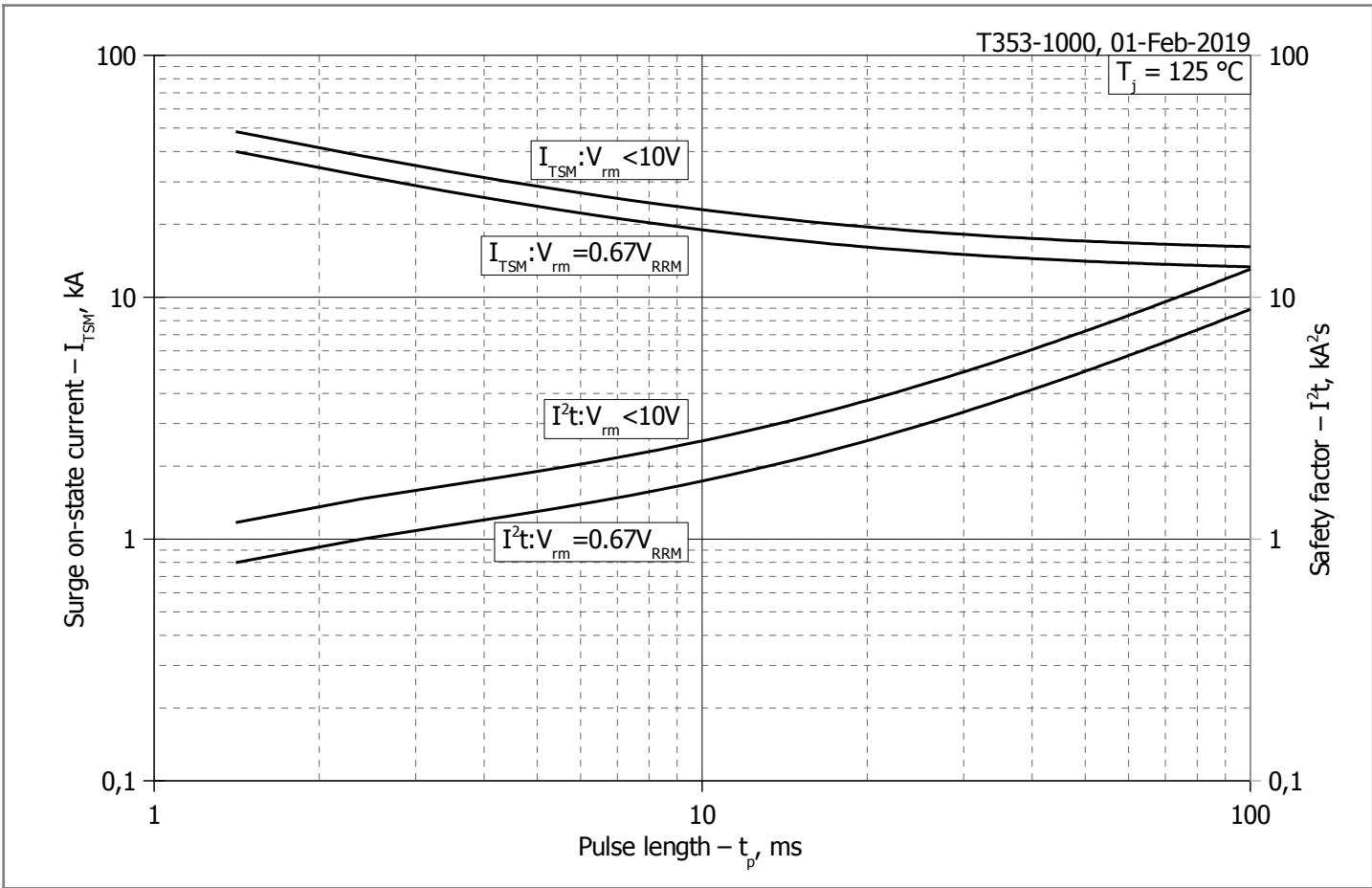

Fig 13 – Maximum surge and I^2t ratings

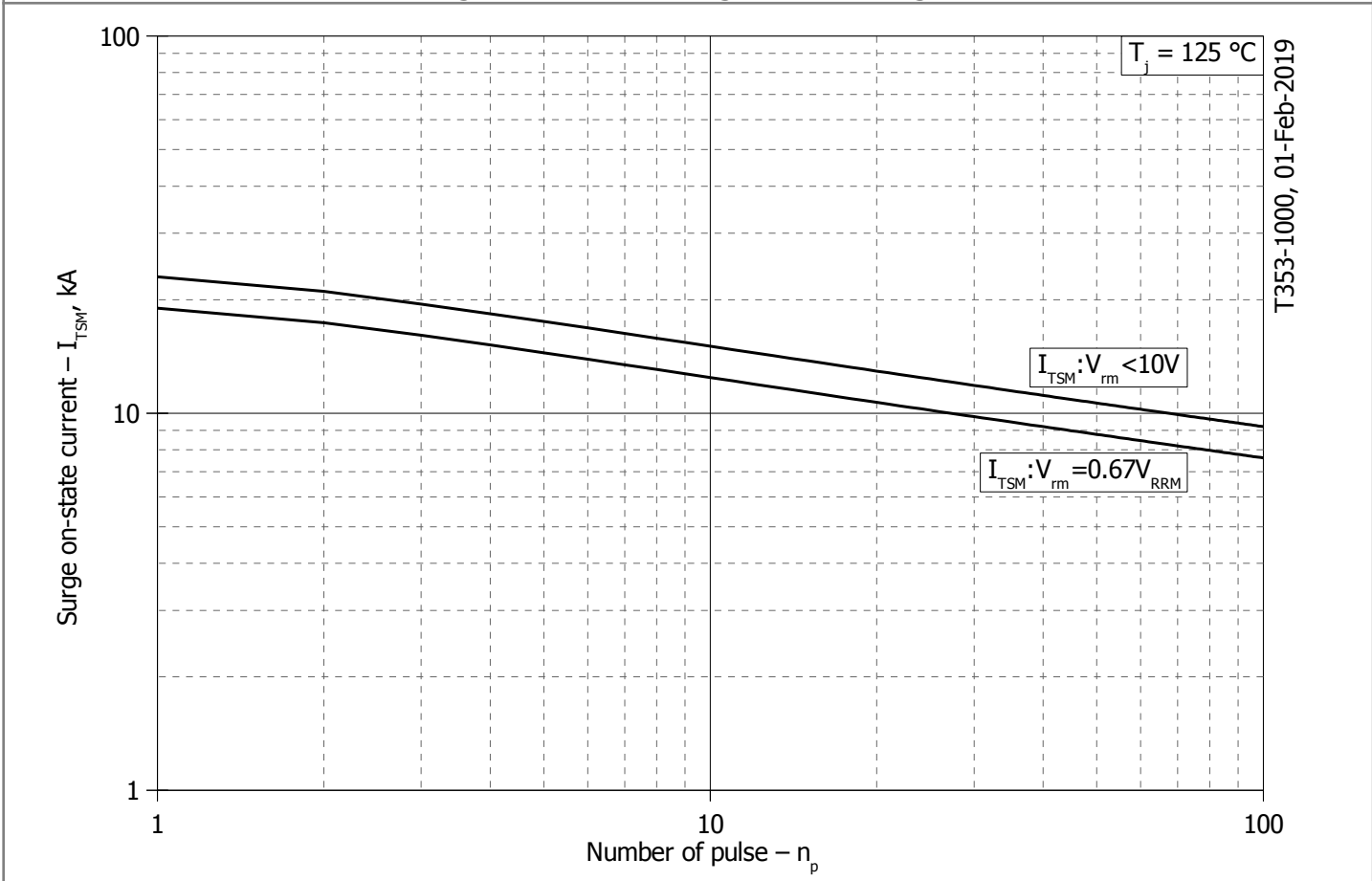

Fig 14 – Maximum surge ratings