



High power cycling capability  
Low on-state and switching losses  
Designed for traction and industrial applications

## Phase Control Thyristor Type T273-1250-44

Mean on-state current		$I_{TAV}$	1250 A	
Repetitive peak off-state voltage		$V_{DRM}$	3800 ÷ 4400 V	
Repetitive peak reverse voltage		$V_{RRM}$		
Turn-off time		$t_q$	630, 800 $\mu$ s	
$V_{DRM}, V_{RRM}, V$	3800	4000	4200	4400
Voltage code	38	40	42	44
$T_j, ^\circ C$	-60 ÷ 125			

### MAXIMUM ALLOWABLE RATINGS

Symbols and parameters		Units	Values	Test conditions
<b>ON-STATE</b>				
$I_{TAV}$	Mean on-state current	A	1250 1796	$T_c=101^\circ C$ , Double side cooled $T_c=85^\circ C$ , Double side cooled 180° half-sine wave; 50 Hz
$I_{TRMS}$	RMS on-state current	A	1962	$T_c=101^\circ C$ , Double side cooled 180° half-sine wave; 50 Hz
$I_{TSM}$	Surge on-state current	kA	37.0 43.0	$T_j=T_{j\ max}$ $T_j=25^\circ C$ 180° half-sine wave; $t_p=10\ ms$ ; single pulse; $V_D=V_R=0\ V$ ; Gate pulse: $I_G=2\ A$ ; $t_{GP}=50\ \mu s$ ; $di_G/dt \geq 1\ A/\mu s$
			39.0 45.0	$T_j=T_{j\ max}$ $T_j=25^\circ C$ 180° half-sine wave; $t_p=8.3\ ms$ ; single pulse; $V_D=V_R=0\ V$ ; Gate pulse: $I_G=2\ A$ ; $t_{GP}=50\ \mu s$ ; $di_G/dt \geq 1\ A/\mu s$
$I^2t$	Safety factor	$A^2s \cdot 10^3$	6800 9200	$T_j=T_{j\ max}$ $T_j=25^\circ C$ 180° half-sine wave; $t_p=10\ ms$ ; single pulse; $V_D=V_R=0\ V$ ; Gate pulse: $I_G=2\ A$ ; $t_{GP}=50\ \mu s$ ; $di_G/dt \geq 1\ A/\mu s$
			6300 8400	$T_j=T_{j\ max}$ $T_j=25^\circ C$ 180° half-sine wave; $t_p=8.3\ ms$ ; single pulse; $V_D=V_R=0\ V$ ; Gate pulse: $I_G=2\ A$ ; $t_{GP}=50\ \mu s$ ; $di_G/dt \geq 1\ A/\mu s$
<b>BLOCKING</b>				
$V_{DRM}, V_{RRM}$	Repetitive peak off-state and Repetitive peak reverse voltages	V	3800 ÷ 4400	$T_{j\ min} < T_j < T_{j\ max}$ ; 180° half-sine wave; 50 Hz; Gate open
$V_{DSM}, V_{RSM}$	Non-repetitive peak off-state and Non-repetitive peak reverse voltages	V	3900 ÷ 4500	$T_{j\ min} < T_j < T_{j\ max}$ ; 180° half-sine wave; single pulse; Gate open
$V_D, V_R$	Direct off-state and Direct reverse voltages	V	$0.6 \cdot V_{DRM}$ $0.6 \cdot V_{RRM}$	$T_j=T_{j\ max}$ ; Gate open

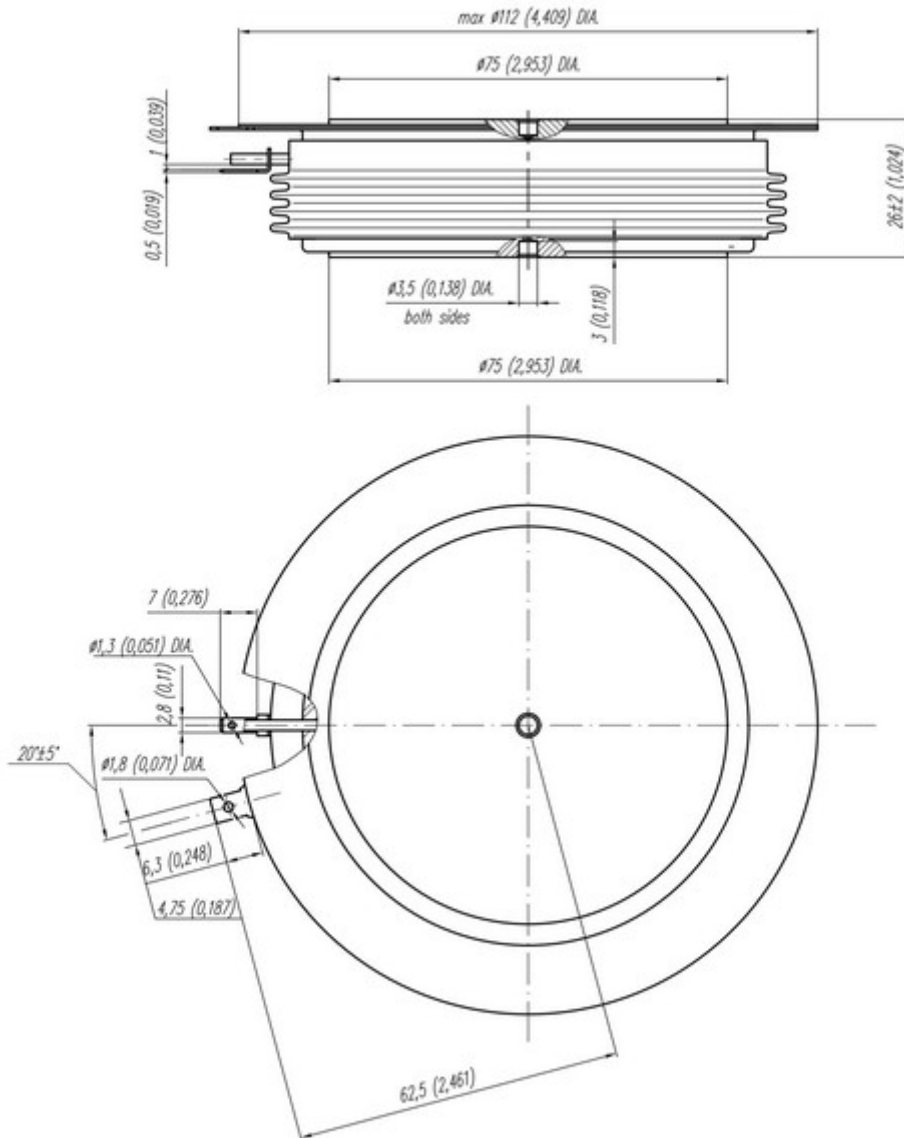
<b>TRIGGERING</b>				
$I_{FGM}$	Peak forward gate current	A	10	$T_j = T_{j\ max}$
$V_{RGM}$	Peak reverse gate voltage	V	5	
$P_G$	Gate power dissipation	W	5	$T_j = T_{j\ max}$ for DC gate current
<b>SWITCHING</b>				
$(di_T/dt)_{crit}$	Critical rate of rise of on-state current non-repetitive ( $f=1\ Hz$ )	A/ $\mu s$	1250	$T_j = T_{j\ max}$ ; $V_D = 0.67 \cdot V_{DRM}$ ; $I_{TM} = 7000\ A$ ; Gate pulse: $I_G = 2\ A$ ; $t_{GP} = 50\ \mu s$ ; $di_G/dt \geq 2\ A/\mu s$
<b>THERMAL</b>				
$T_{stg}$	Storage temperature	$^{\circ}C$	-60÷50	
$T_j$	Operating junction temperature	$^{\circ}C$	-60÷125	
<b>MECHANICAL</b>				
F	Mounting force	kN	40.0÷50.0	
a	Acceleration	m/s <sup>2</sup>	50	Device clamped

## CHARACTERISTICS

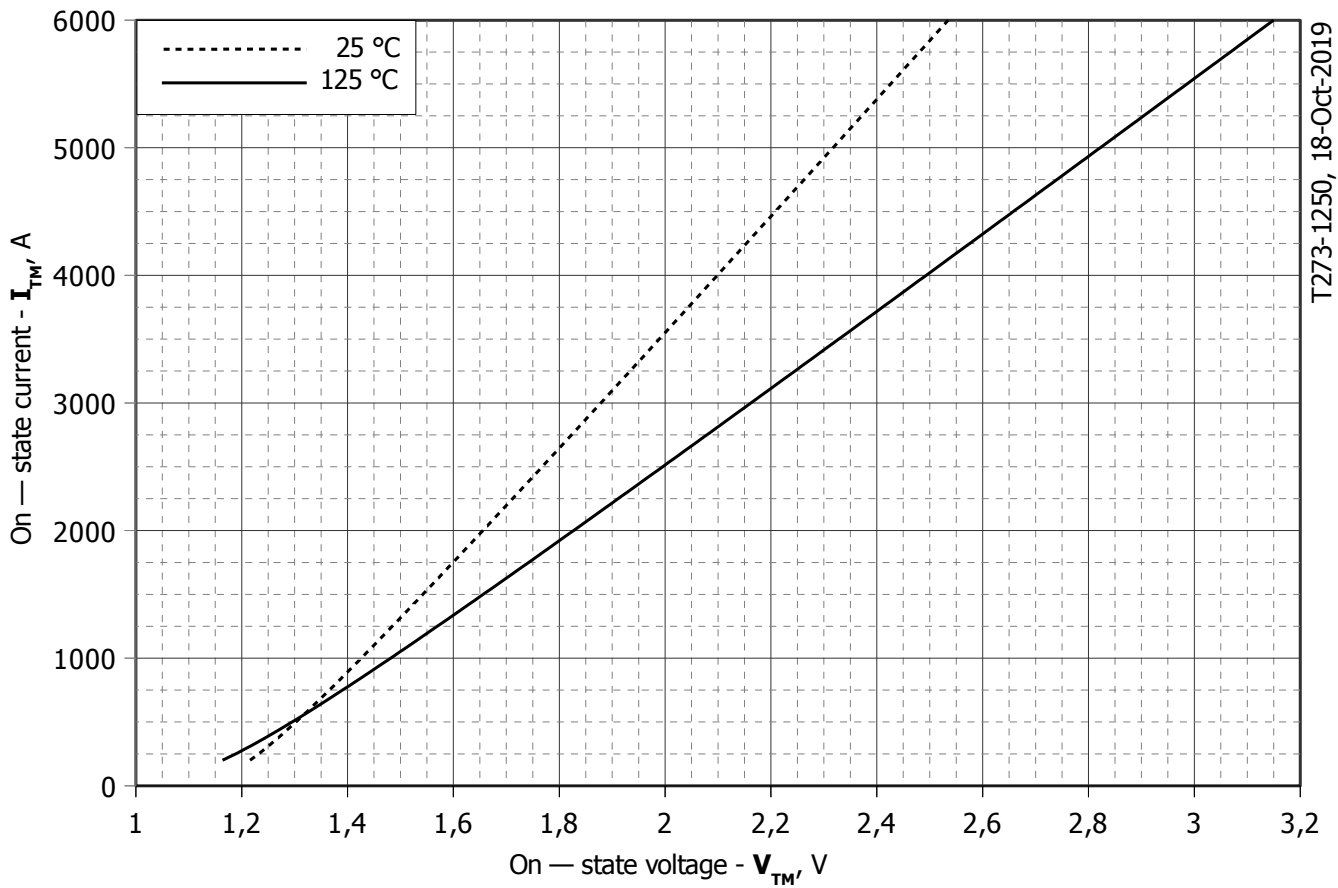
Symbols and parameters		Units	Values	Conditions	
<b>ON-STATE</b>					
$V_{TM}$	Peak on-state voltage, max	V	2.10	$T_j = 25\ ^{\circ}C$ ; $I_{TM} = 3925\ A$	
$V_{T(TO)}$	On-state threshold voltage, max	V	1.164	$T_j = T_{j\ max}$ ;	
$r_T$	On-state slope resistance, max	m $\Omega$	0.331	$0.5\ \pi\ I_{TAV} < I_T < 1.5\ \pi\ I_{TAV}$	
$I_L$	Latching current, max	mA	1500	$T_j = 25\ ^{\circ}C$ ; $V_D = 12\ V$ ; Gate pulse: $I_G = 2\ A$ ; $t_{GP} = 50\ \mu s$ ; $di_G/dt \geq 1\ A/\mu s$	
$I_H$	Holding current, max	mA	300	$T_j = 25\ ^{\circ}C$ ; $V_D = 12\ V$ ; Gate open	
<b>BLOCKING</b>					
$I_{DRM}, I_{RRM}$	Repetitive peak off-state and Repetitive peak reverse currents, max	mA	300	$T_j = T_{j\ max}$ ; $V_D = V_{DRM}$ ; $V_R = V_{RRM}$	
$(dv_D/dt)_{crit}$	Critical rate of rise of off-state voltage <sup>1)</sup> , min	V/ $\mu s$	200, 320, 500, 1000, 1600, 2000, 2500	$T_j = T_{j\ max}$ ; $V_D = 0.67 \cdot V_{DRM}$ ; Gate open	
<b>TRIGGERING</b>					
$V_{GT}$	Gate trigger direct voltage, max	V	3.00 2.50 1.50	$T_j = T_{j\ min}$ $T_j = 25\ ^{\circ}C$ $T_j = T_{j\ max}$	$V_D = 12\ V$ ; $I_D = 3\ A$ ; Direct gate current
$I_{GT}$	Gate trigger direct current, max	mA	400 250 150	$T_j = T_{j\ min}$ $T_j = 25\ ^{\circ}C$ $T_j = T_{j\ max}$	
$V_{GD}$	Gate non-trigger direct voltage, min	V	0.40	$T_j = T_{j\ max}$ ;	
$I_{GD}$	Gate non-trigger direct current, min	mA	45.00	$V_D = 0.67 \cdot V_{DRM}$ ; Direct gate current	
<b>SWITCHING</b>					
$t_{gd}$	Delay time, max	$\mu s$	2.75	$T_j = 25\ ^{\circ}C$ ; $V_D = 1500\ V$ ; $I_{TM} = I_{TAV}$ ; $di/dt = 200\ A/\mu s$ ;	
$t_{gt}$	Turn-on time, max	$\mu s$	12.0	Gate pulse: $I_G = 2\ A$ ; $V_G = 20\ V$ ; $t_{GP} = 50\ \mu s$ ; $di_G/dt = 2\ A/\mu s$	
$t_q$	Turn-off time <sup>2)</sup> , max	$\mu s$	630, 800	$dv_D/dt = 50\ V/\mu s$ ; $T_j = T_{j\ max}$ ; $I_{TM} = I_{TAV}$ ; $di_R/dt = -5\ A/\mu s$ ; $V_R = 100V$ ; $V_D = 0.67 \cdot V_{DRM}$	
$Q_{rr}$	Total recovered charge, max	$\mu C$	6080	$T_j = T_{j\ max}$ ; $I_{TM} = 1250\ A$ ;	
$t_{rr}$	Reverse recovery time, max	$\mu s$	72	$di_R/dt = -5\ A/\mu s$ ;	
$I_{rrM}$	Peak reverse recovery current, max	A	169	$V_R = 100\ V$	

THERMAL					
$R_{thjc}$	Thermal resistance, junction to case, max	°C/W	0.0085	Direct current	Double side cooled
$R_{thjc-A}$			0.0187		Anode side cooled
$R_{thjc-K}$			0.0153		Cathode side cooled
$R_{thck}$	Thermal resistance, case to heatsink, max	°C/W	0.0020	Direct current	
MECHANICAL					
w	Weight, max	g	1500		
$D_s$	Surface creepage distance	mm (inch)	36.60 (1.441)		
$D_a$	Air strike distance	mm (inch)	16.20 (0.638)		

PART NUMBERING GUIDE							NOTES							
T	273	1250	44	A2	B2	N	1) Critical rate of rise of off-state voltage							
1	2	3	4	5	6	7	Symbol of Group	P2	K2	E2	A2	T1	P1	M1
							$(dv_D/dt)_{crit}$ , V/μs	200	320	500	1000	1600	2000	2500
1. Phase Control Thyristor							2) Turn-off time ( $dv_D/dt=50$ V/μs)							
2. Design version							Symbol of Group	C2			B2			
3. Mean on-state current, A							$t_q$ , μs	630			800			
4. Voltage code														
5. Critical rate of rise of off-state voltage, V/μs														
6. Turn-off time ( $dv_D/dt=50$ V/μs)														
7. Ambient conditions: N – normal; T – tropical														



All dimensions in millimeters (inches)



T273-1250, 18-Oct-2019

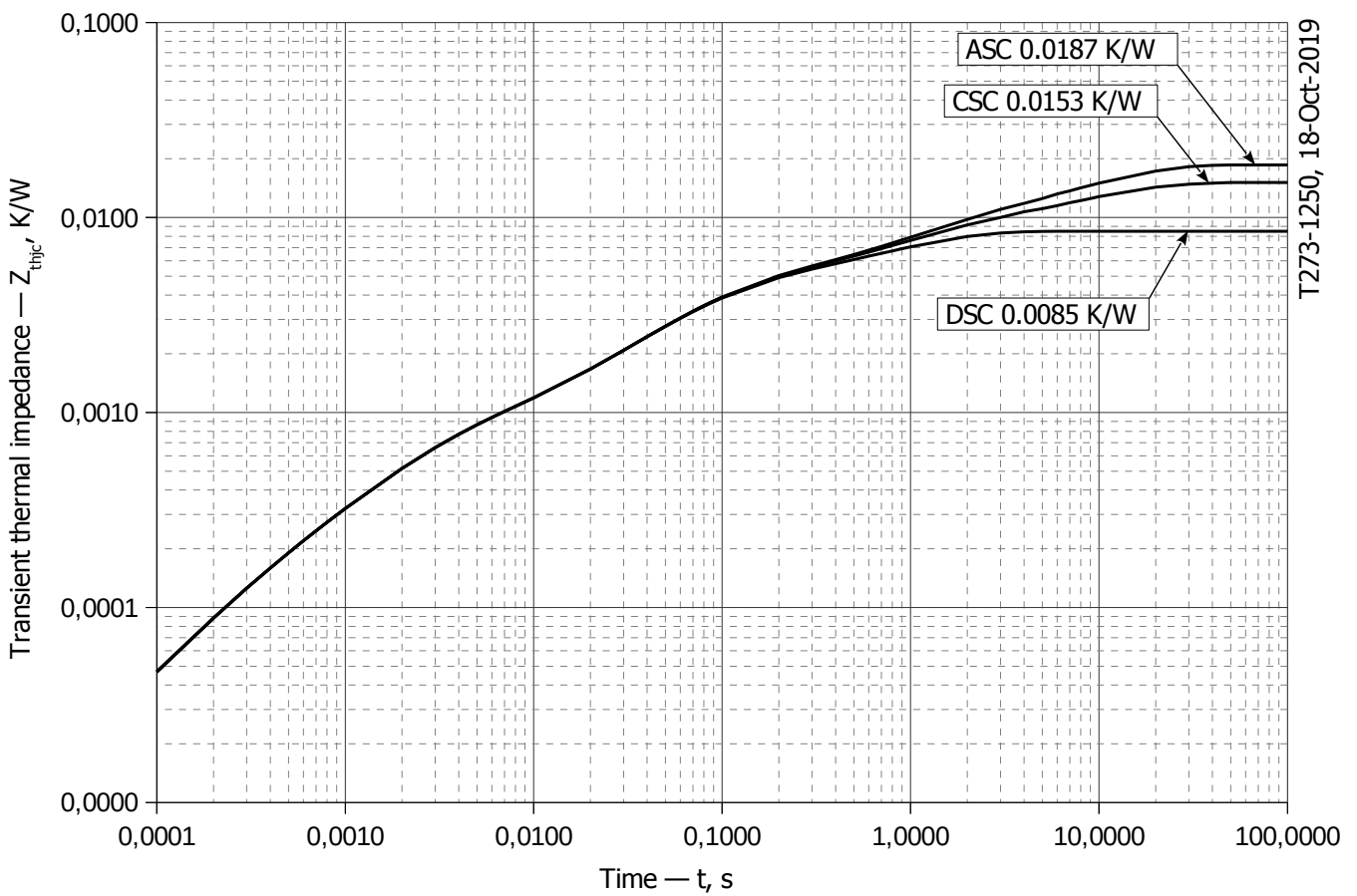
**Fig 1 – On-state characteristics of Limit device**

Analytical function for On-state characteristic:

$$V_T = A + B \cdot i_T + C \cdot \ln(i_T + 1) + D \cdot \sqrt{i_T}$$

	Coefficients for max curves	
	$T_j = 25^\circ\text{C}$	$T_j = T_{j,max}$
<b>A</b>	1.03580000	0.87930000
<b>B</b>	0.00021417	0.00032394
<b>C</b>	0.02637200	0.00032394
<b>D</b>	-0.00019858	-0.00062058

**On-state characteristic model (see Fig. 1)**



T273-1250, 18-Oct-2019

**Fig 2 – Transient thermal impedance  $Z_{thjc}$  vs. time  $t$**

Analytical function for Transient thermal impedance junction to case  $Z_{thjc}$  for DC:

$$Z_{thjc} = \sum_{i=1}^n R_i \left( 1 - e^{-\frac{t}{\tau_i}} \right)$$

Where  $i = 1$  to  $n$ ,  $n$  is the number of terms in the series.

$t$  = Duration of heating pulse in seconds.

$Z_{thjc}$  = Thermal resistance at time  $t$ .

$R_i$  = Amplitude of  $p_{th}$  term.

$\tau_i$  = Time constant of  $r_{th}$  term.

DC Double side cooled

$i$	1	2	3	4	5	6
$R_i$ , K/W	0.00007989	0.002973	0.0005936	0.000846	0.00005975	0.003948
$\tau_i$ , s	1.688	0.06219	0.002329	0.138	0.0003243	0.9533

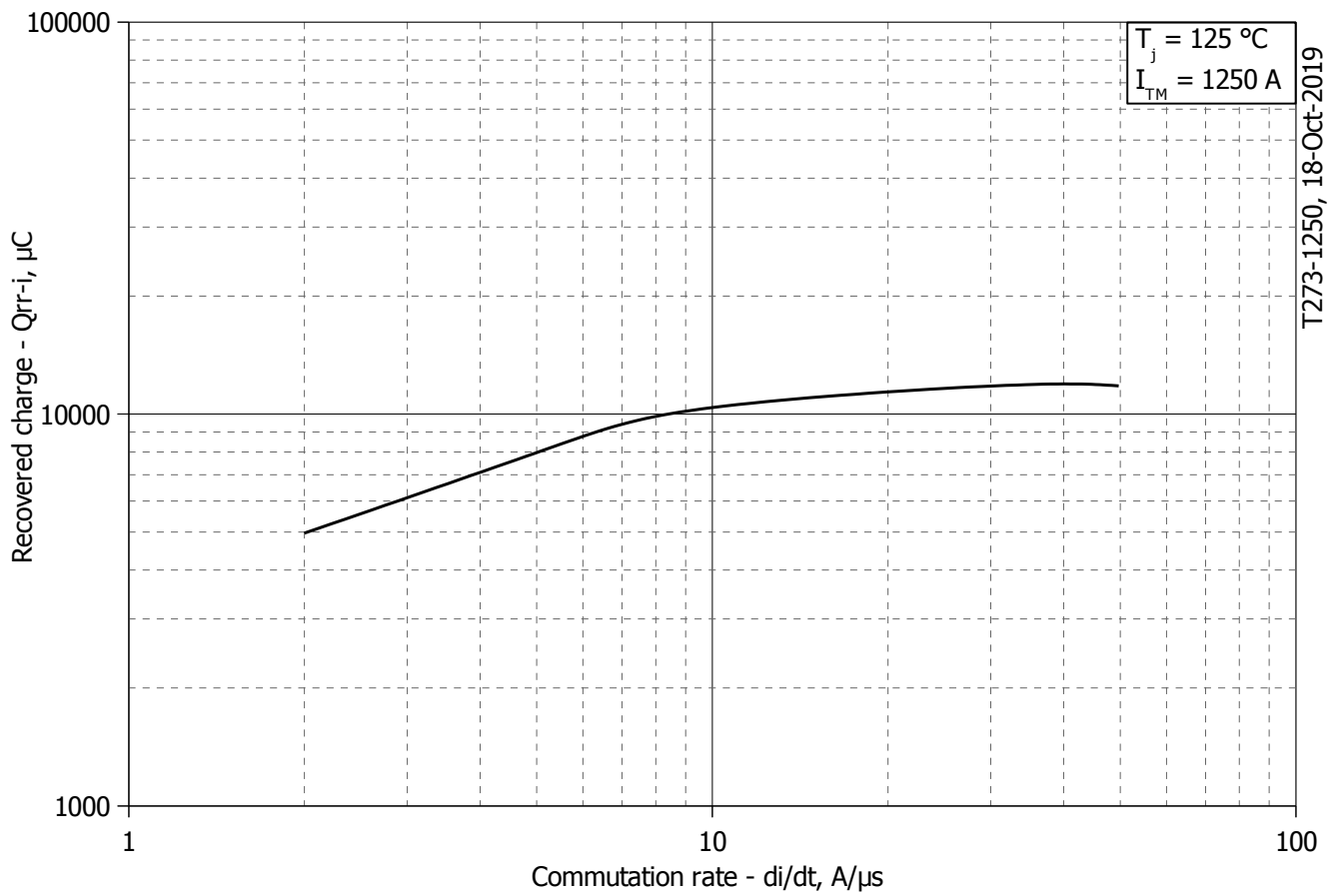
DC Anode side cooled

$i$	1	2	3	4	5	6
$R_i$ , K/W	0.01013	0.004062	0.0009401	0.002853	0.0005963	0.00005641
$\tau_i$ , s	9.747	1.058	0.1304	0.06179	0.002313	0.0003013

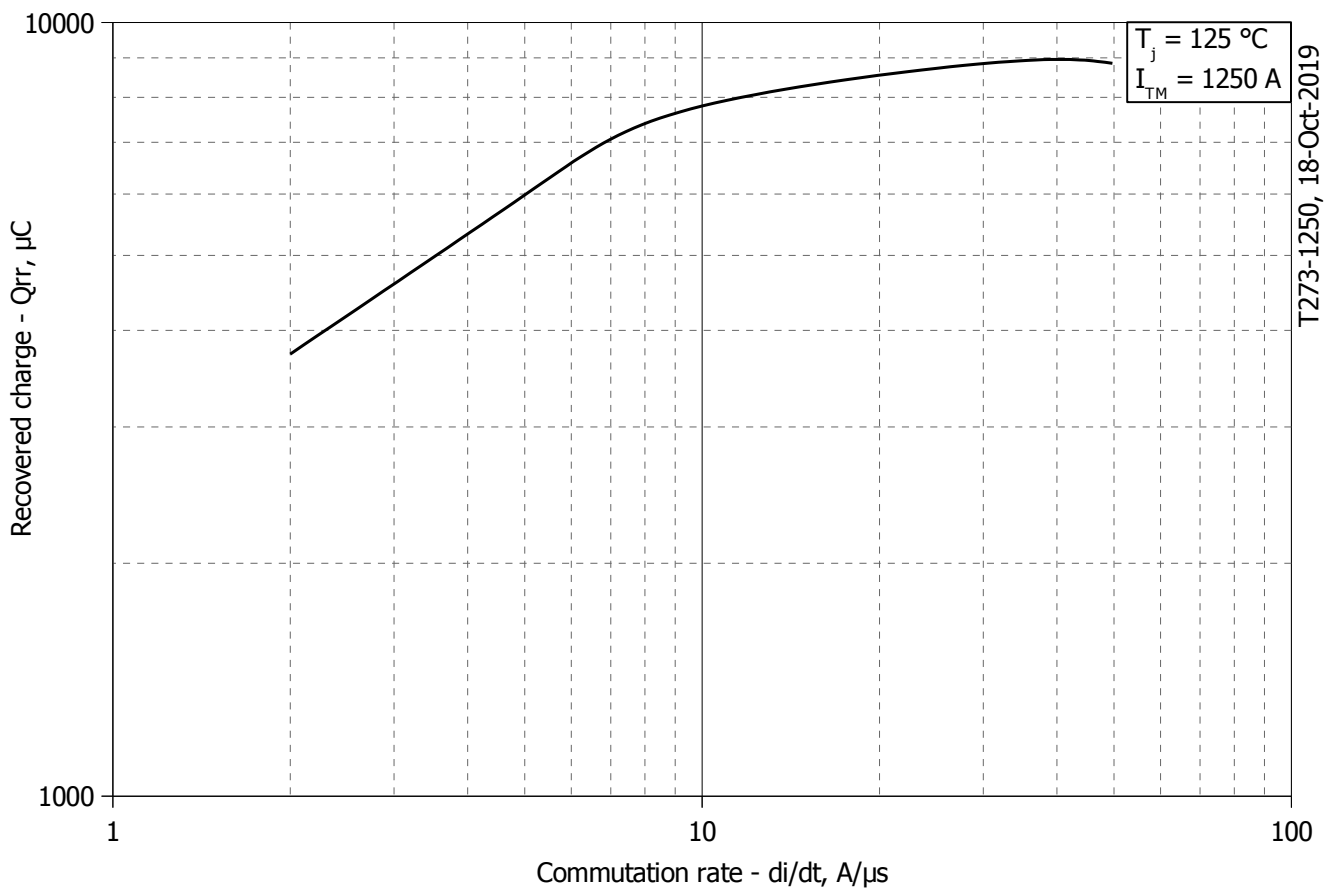
DC Cathode side cooled

$i$	1	2	3	4	5	6
$R_i$ , K/W	0.006619	0.004034	0.0008595	0.002956	0.0005965	0.00005689
$\tau_i$ , s	9.744	1.025	0.1394	0.06237	0.002318	0.0003037

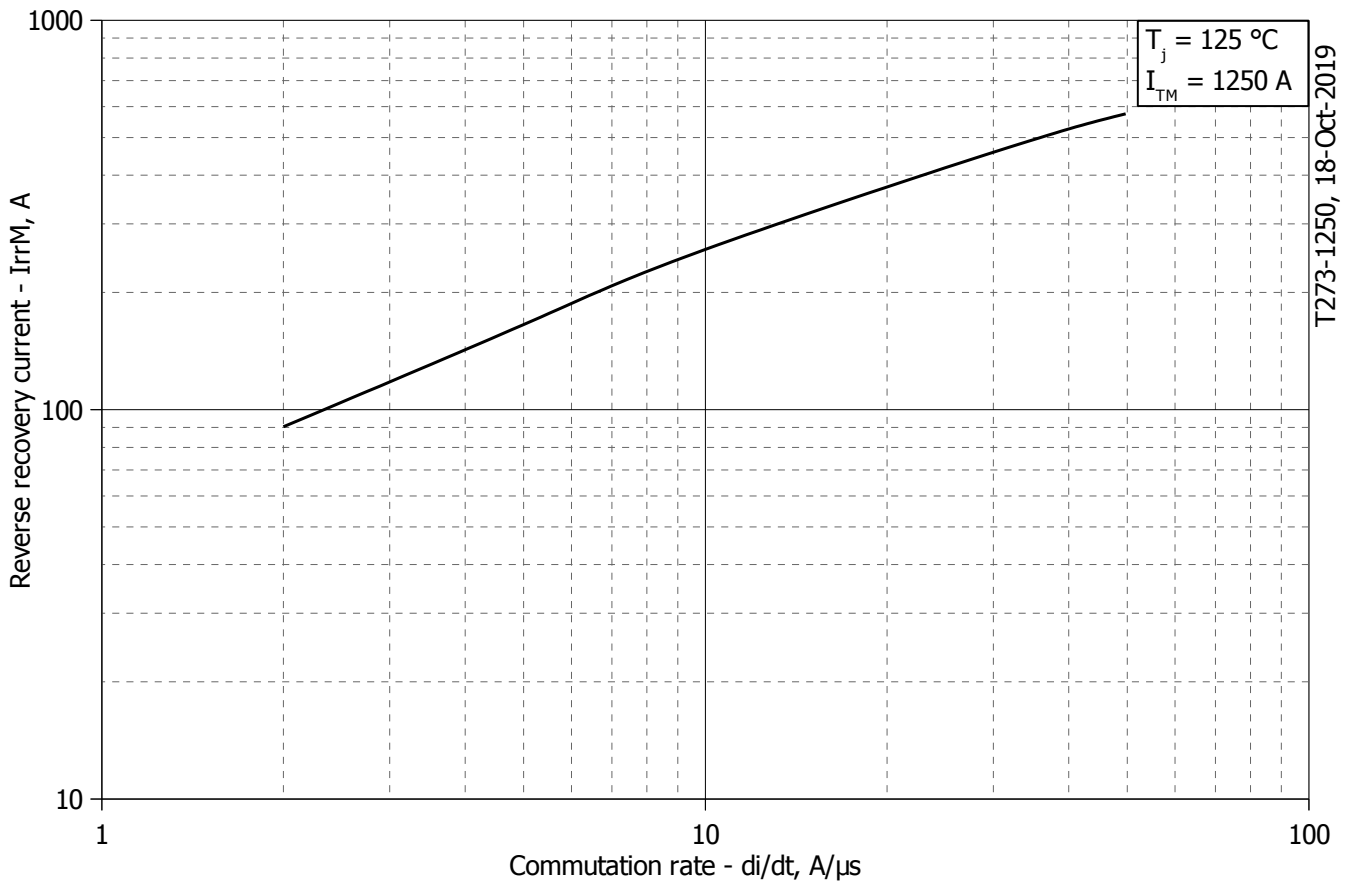
**Transient thermal impedance junction to case  $Z_{thjc}$  model (see Fig. 2)**



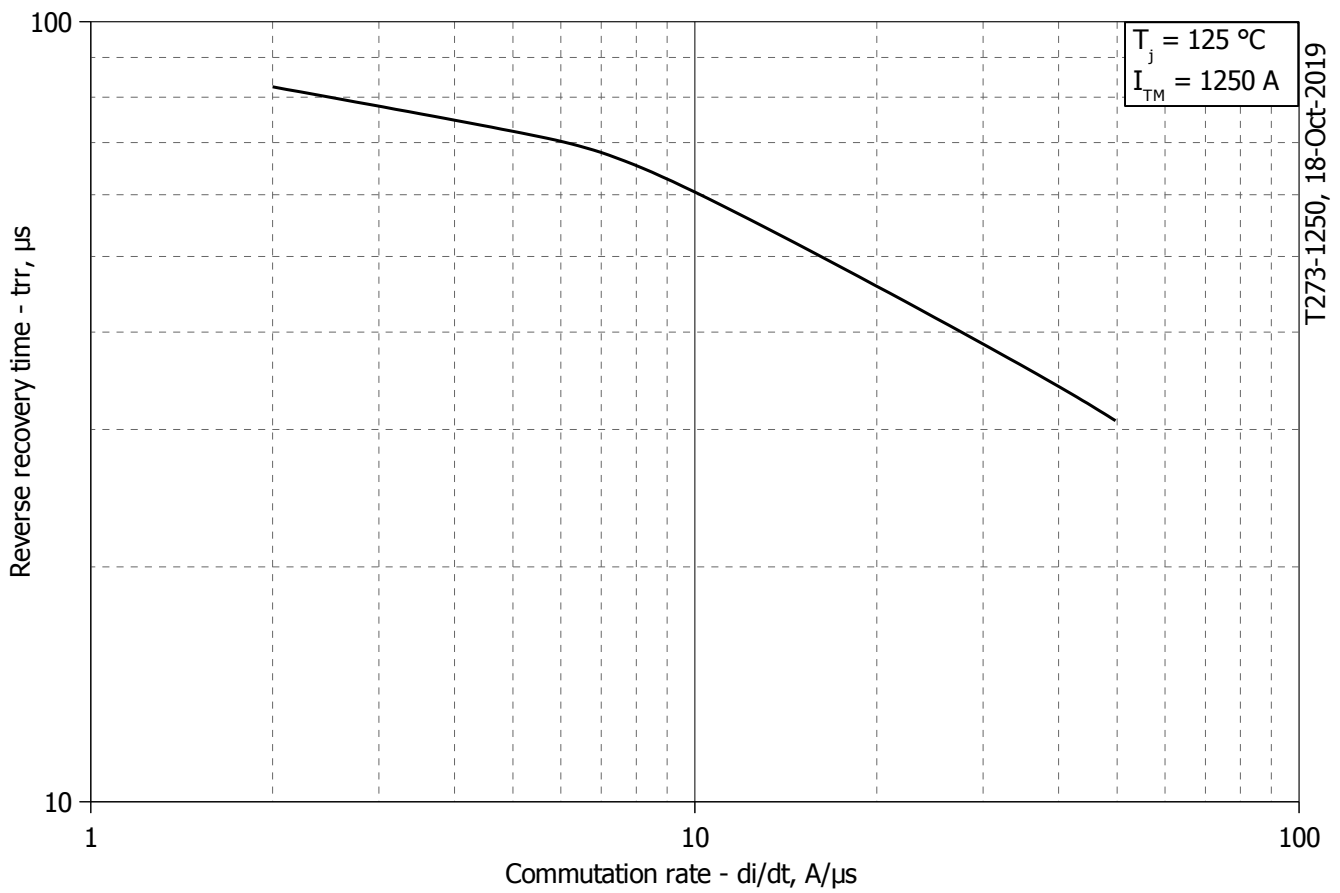
**Fig 3 – Maximum recovered charge  $Q_{rr-i}$  (integral) vs. commutation rate  $di_R/dt$**



**Fig 4 – Maximum recovered charge  $Q_{rr}$  vs. commutation rate  $di_R/dt$  (25% chord)**

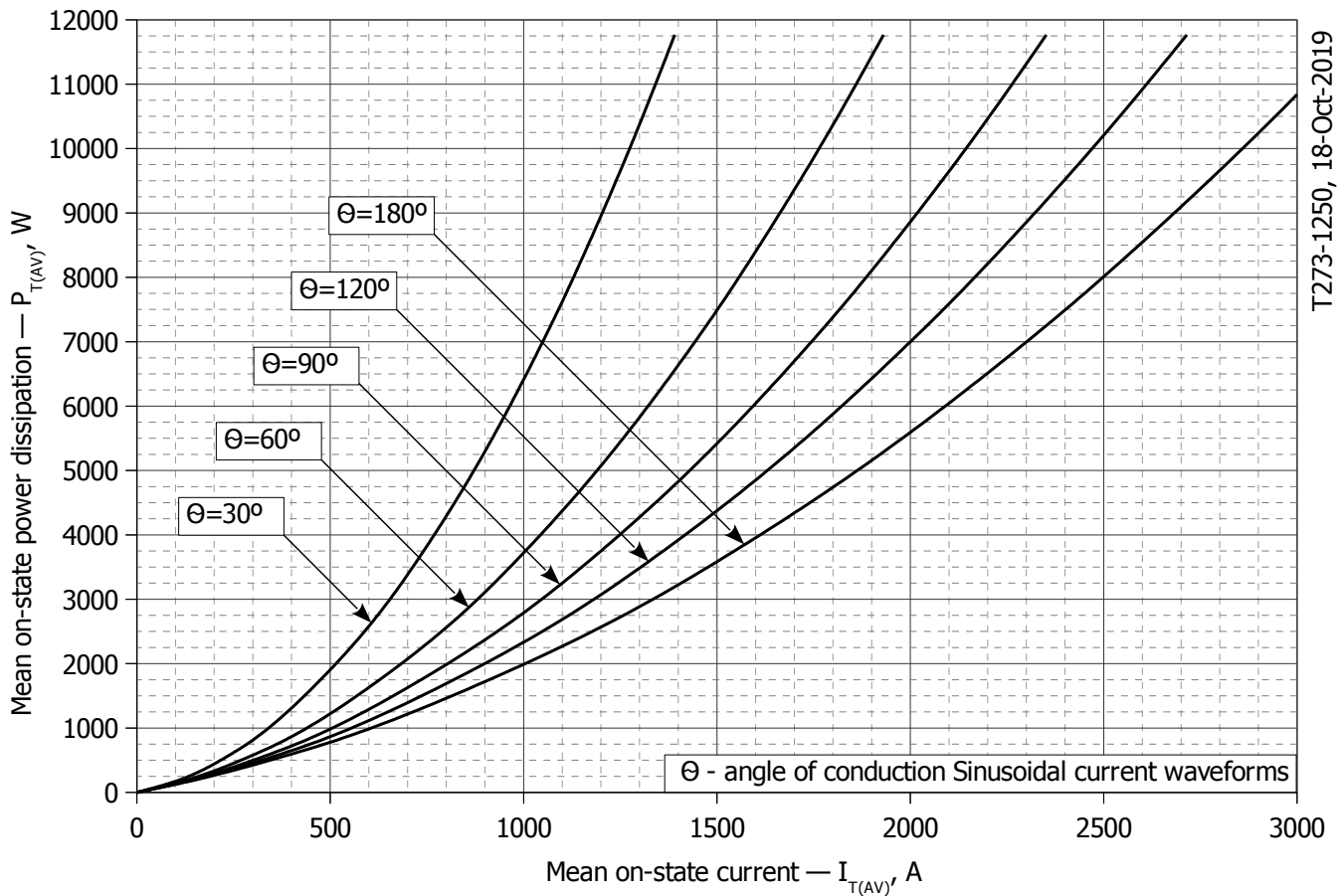


**Fig 5 – Maximum reverse recovery current  $I_{rrM}$  vs. commutation rate  $di_R/dt$**



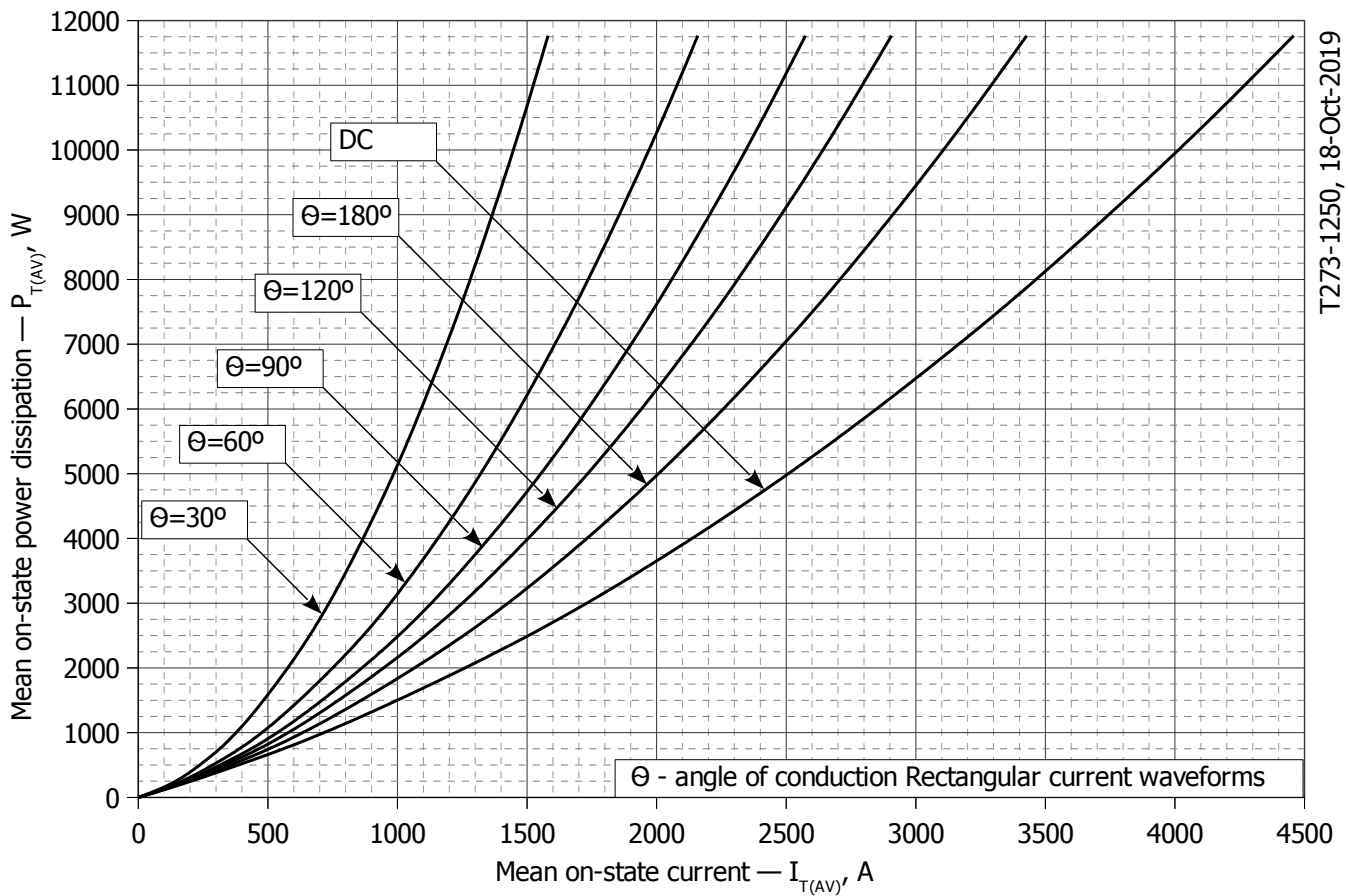
**Fig 6 – Maximum recovery time  $t_{rr}$  vs. commutation rate  $di_R/dt$  (25% chord)**





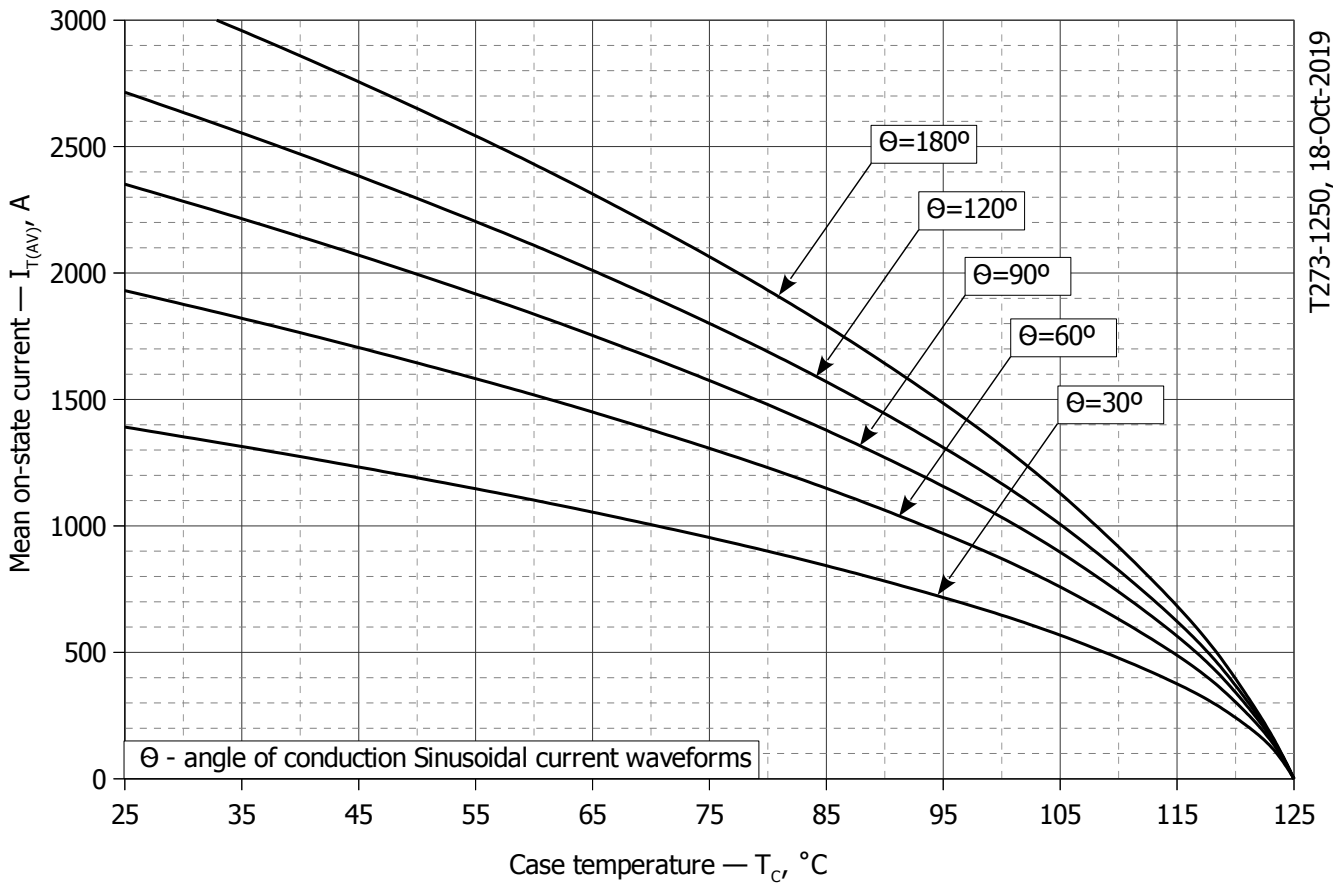
T273-1250, 18-Oct-2019

**Fig. 7 - Mean on-state power dissipation  $P_{TAV}$  vs. mean on-state current  $I_{TAV}$  for sinusoidal current waveforms at different conduction angles ( $f=50\text{Hz}$ , DSC)**

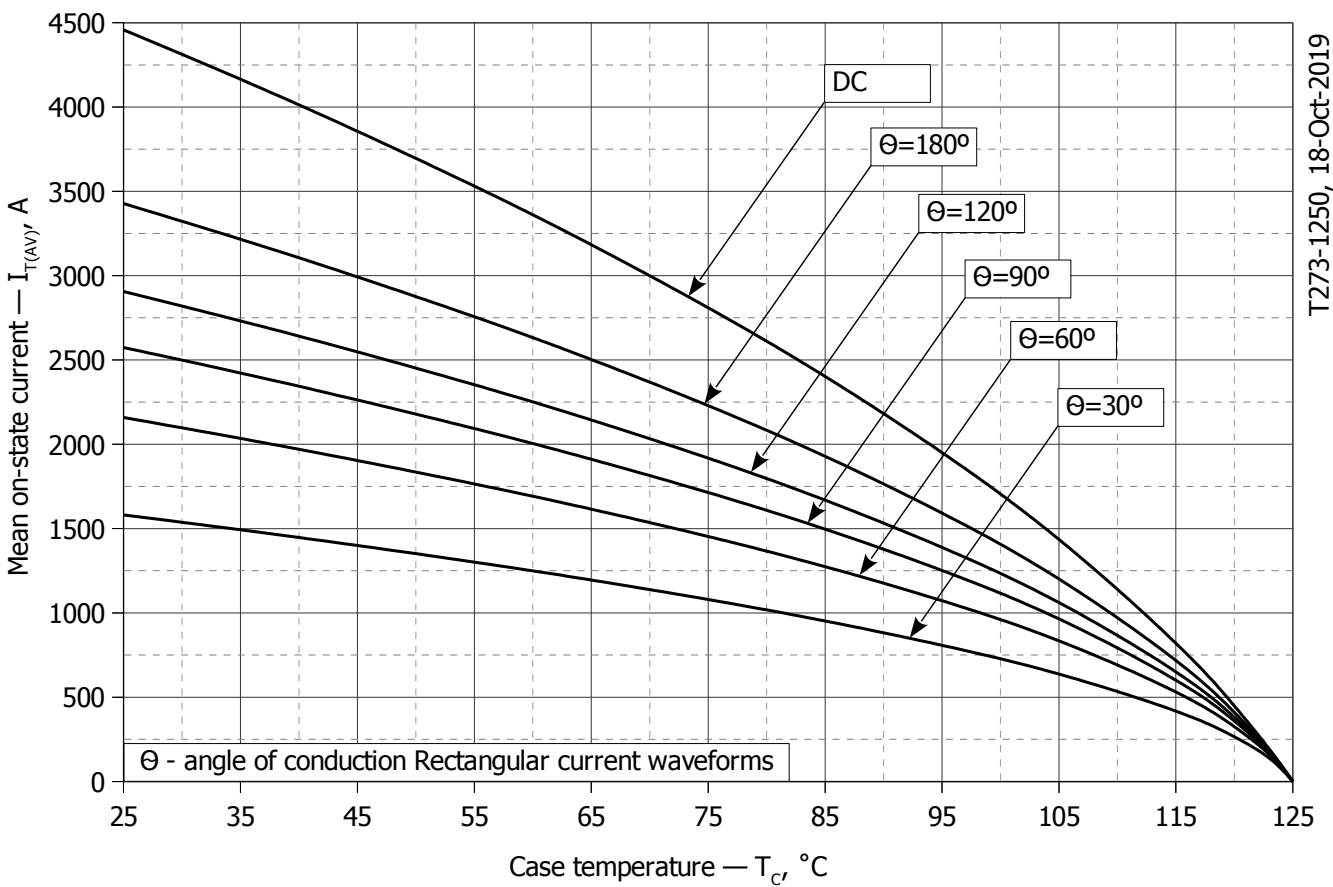


T273-1250, 18-Oct-2019

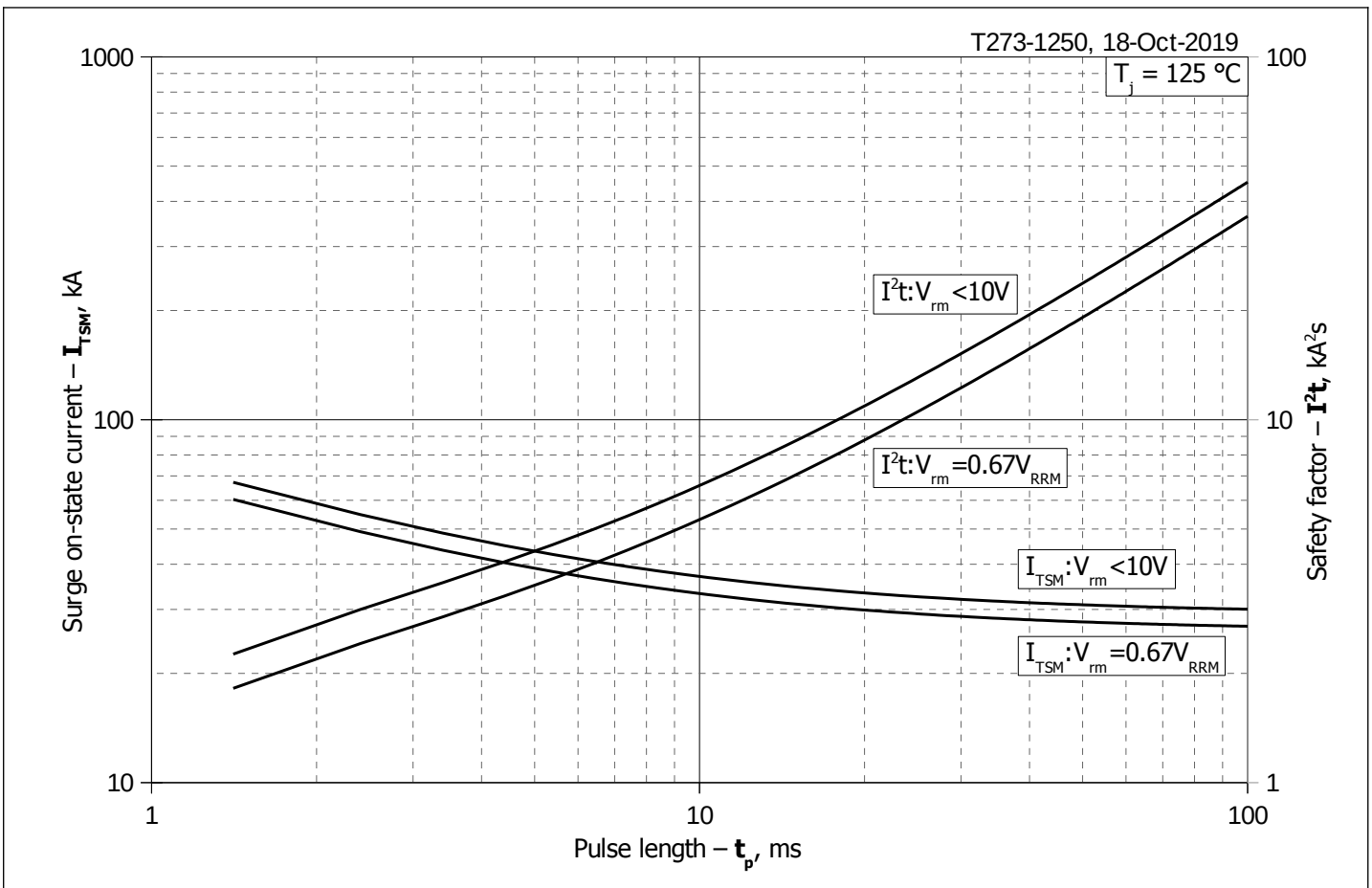
**Fig. 8 - Mean on-state power dissipation  $P_{TAV}$  vs. mean on-state current  $I_{TAV}$  for rectangular current waveforms at different conduction angles and for DC ( $f=50\text{Hz}$ , DSC)**



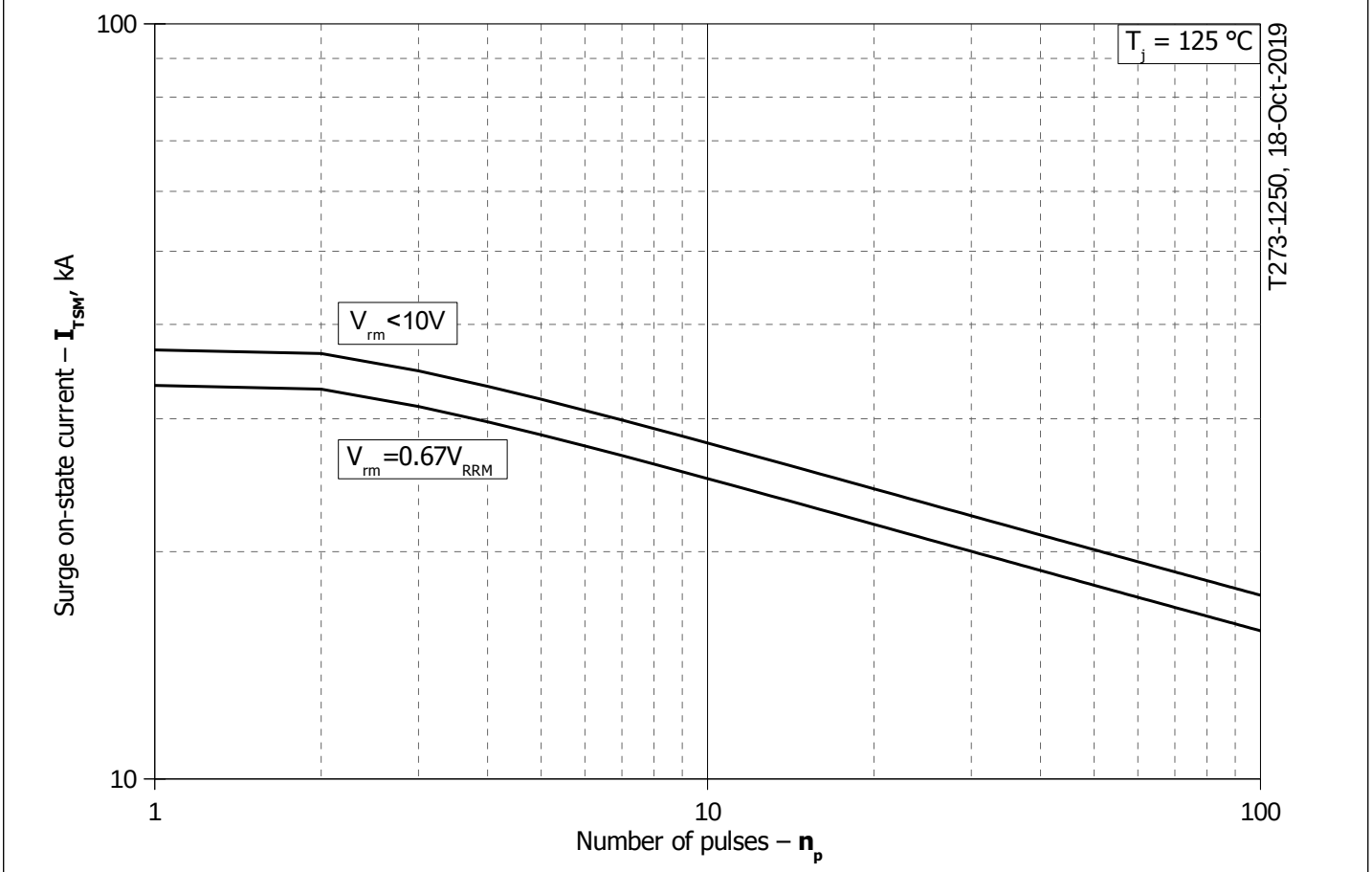
**Fig. 9 – Mean on-state current  $I_{TAV}$  vs. case temperature  $T_c$  for sinusoidal current waveforms at different conduction angles ( $f=50Hz$ , DSC)**



**Fig. 10 - Mean on-state current  $I_{TAV}$  vs. case temperature  $T_c$  for rectangular current waveforms at different conduction angles and for DC ( $f=50Hz$ , DSC)**



**Fig. 11 – Maximum surge on-state current  $I_{TSM}$  and safety factor  $I^2t$  vs. pulse length  $t_p$**



**Fig. 12 - Maximum surge on-state current  $I_{TSM}$  vs. number of pulses  $n_p$**