



Optimum power handling  
Low on-state and switching losses  
Designed for traction and industrial applications

## Phase Control Stud Thyristor Type T171-200-18

Mean on-state current	$I_{TAV}$		200 A														
Repetitive peak off-state voltage	$V_{DRM}$		100÷1800 V														
Repetitive peak reverse voltage	$V_{RRM}$																
Turn-off time	$t_q$		125, 160, 200, 250, 320, 400, 500 $\mu$ s														
$V_{DRM}, V_{RRM}, V$	100	200	300	400	500	600	700	800	900	1000	1100	1200	1300	1400	1500	1600	1800
Voltage code	1	2	3	4	5	6	7	8	9	10	11	12	13	14	15	16	18
$T_j, ^\circ C$	-60÷125																

### MAXIMUM ALLOWABLE RATINGS

Symbols and parameters		Units	Values	Test conditions	
<b>ON-STATE</b>					
$I_{TAV}$	Mean on-state current	A	200 310	$T_c = 102^\circ C$ ; $T_c = 85^\circ C$ ; 180° half-sine wave; 50 Hz	
$I_{TRMS}$	RMS on-state current	A	314	$T_c = 102^\circ C$ ; 180° half-sine wave; 50 Hz	
$I_{TSM}$	Surge on-state current	kA	6.0 7.0	$T_j = T_{jmax}$ $T_j = 25^\circ C$	180° half-sine wave; $t_p = 10$ ms; single pulse; $V_D = V_R = 0$ V; Gate pulse: $I_G = 2$ A; $t_{GP} = 50 \mu s$ ; $di_G/dt \geq 1$ A/ $\mu s$
			6.5 7.5	$T_j = T_{jmax}$ $T_j = 25^\circ C$	180° half-sine wave; $t_p = 8.3$ ms; single pulse; $V_D = V_R = 0$ V; Gate pulse: $I_G = 2$ A; $t_{GP} = 50 \mu s$ ; $di_G/dt \geq 1$ A/ $\mu s$
$I^2t$	Safety factor	$A^2s \cdot 10^3$	180 240	$T_j = T_{jmax}$ $T_j = 25^\circ C$	180° half-sine wave; $t_p = 10$ ms; single pulse; $V_D = V_R = 0$ V; Gate pulse: $I_G = 2$ A; $t_{GP} = 50 \mu s$ ; $di_G/dt \geq 1$ A/ $\mu s$
			170 230	$T_j = T_{jmax}$ $T_j = 25^\circ C$	180° half-sine wave; $t_p = 8.3$ ms; single pulse; $V_D = V_R = 0$ V; Gate pulse: $I_G = 2$ A; $t_{GP} = 50 \mu s$ ; $di_G/dt \geq 1$ A/ $\mu s$
<b>BLOCKING</b>					
$V_{DRM}, V_{RRM}$	Repetitive peak off-state and Repetitive peak reverse voltages	V	100÷1800	$T_{jmin} < T_j < T_{jmax}$ ; 180° half-sine wave; 50 Hz; Gate open	
$V_{DSM}, V_{RSM}$	Non-repetitive peak off-state and Non-repetitive peak reverse voltages	V	110÷1900	$T_{jmin} < T_j < T_{jmax}$ ; 180° half-sine wave; single pulse; Gate open	
$V_D, V_R$	Direct off-state and Direct reverse voltages	V	$0.6 \cdot V_{DRM}$ $0.6 \cdot V_{RRM}$	$T_j = T_{jmax}$ ; Gate open	

<b>TRIGGERING</b>				
$I_{FGM}$	Peak forward gate current	A	6	$T_j = T_{j\max}$
$V_{RGM}$	Peak reverse gate voltage	V	5	
$P_G$	Gate power dissipation	W	3	$T_j = T_{j\max}$ for DC gate current
<b>SWITCHING</b>				
$(di_T/dt)_{crit}$	Critical rate of rise of on-state current non-repetitive (f=1 Hz)	A/ $\mu$ s	1000	$T_j = T_{j\max}$ ; $V_D = 0.67 \cdot V_{DRM}$ ; $I_{TM} = 1700$ A; Gate pulse: $I_G = 2$ A; $t_{GP} = 50$ $\mu$ s; $di_G/dt \geq 2$ A/ $\mu$ s
<b>THERMAL</b>				
$T_{stg}$	Storage temperature	$^{\circ}$ C	-60÷50	
$T_j$	Operating junction temperature	$^{\circ}$ C	-60÷125	
<b>MECHANICAL</b>				
M	Tightening torque	Nm	25÷35	
a	Acceleration	m/s <sup>2</sup>	100	

## CHARACTERISTICS

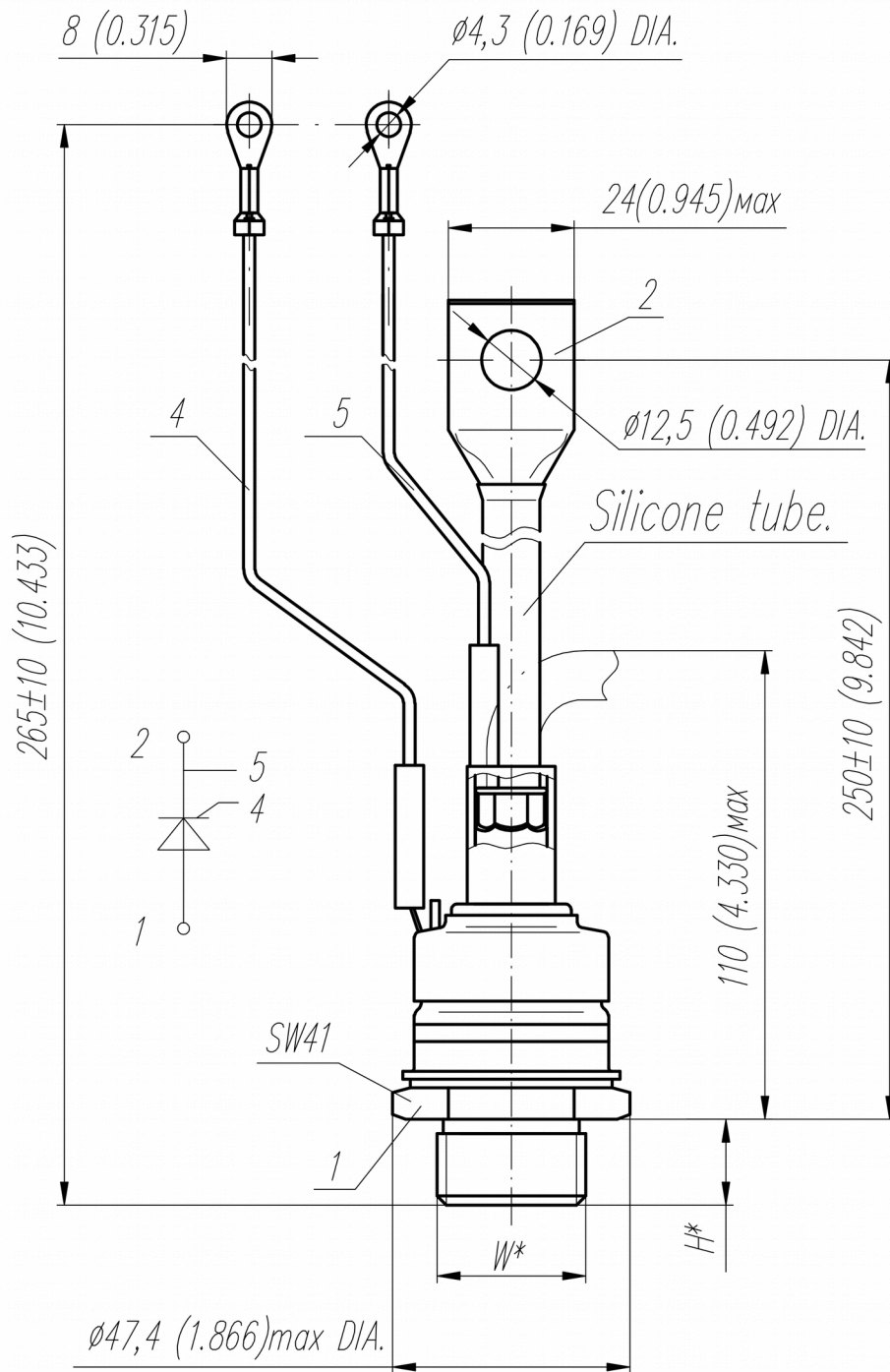
Symbols and parameters		Units	Values	Conditions	
<b>ON-STATE</b>					
$V_{TM}$	Peak on-state voltage, max	V	1.45	$T_j = 25$ $^{\circ}$ C; $I_{TM} = 628$ A	
$V_{T(TO)}$	On-state threshold voltage, max	V	1.027	$T_j = T_{j\max}$ ;	
$r_T$	On-state slope resistance, max	m $\Omega$	0.641	$0.5 \pi I_{TAV} < I_T < 1.5 \pi I_{TAV}$	
$I_L$	Latching current, max	mA	700	$T_j = 25$ $^{\circ}$ C; $V_D = 12$ V; Gate pulse: $I_G = 2$ A; $t_{GP} = 50$ $\mu$ s; $di_G/dt \geq 1$ A/ $\mu$ s	
$I_H$	Holding current, max	mA	300	$T_j = 25$ $^{\circ}$ C; $V_D = 12$ V; Gate open	
<b>BLOCKING</b>					
$I_{DRM}, I_{RRM}$	Repetitive peak off-state and Repetitive peak reverse currents, max	mA	70	$T_j = T_{j\max}$ ; $V_D = V_{DRM}$ ; $V_R = V_{RRM}$	
$(dv_D/dt)_{crit}$	Critical rate of rise of off-state voltage <sup>1)</sup> , min	V/ $\mu$ s	200, 320, 500, 1000	$T_j = T_{j\max}$ ; $V_D = 0.67 \cdot V_{DRM}$ ; Gate open	
<b>TRIGGERING</b>					
$V_{GT}$	Gate trigger direct voltage, max	V	3.00	$T_j = T_{j\min}$	$V_D = 12$ V; $I_D = 3$ A; Direct gate current
			2.50	$T_j = 25$ $^{\circ}$ C	
1.50	$T_j = T_{j\max}$				
$I_{GT}$	Gate trigger direct current, max	mA	400	$T_j = T_{j\min}$	
			250	$T_j = 25$ $^{\circ}$ C	
			150	$T_j = T_{j\max}$	
$V_{GD}$	Gate non-trigger direct voltage, min	V	0.60	$T_j = T_{j\max}$ ; $V_D = 0.67 \cdot V_{DRM}$ ;	
$I_{GD}$	Gate non-trigger direct current, min	mA	35.00	Direct gate current	
<b>SWITCHING</b>					
$t_{gd}$	Delay time, max	$\mu$ s	1.25	$T_j = 25$ $^{\circ}$ C; $V_D = 1000$ V; $I_{TM} = I_{TAV}$ ; $di/dt = 200$ A/ $\mu$ s;	
$t_{gt}$	Turn-on time, max	$\mu$ s	4.00	Gate pulse: $I_G = 2$ A; $V_G = 20$ V; $t_{GP} = 50$ $\mu$ s; $di_G/dt = 2$ A/ $\mu$ s	
$t_q$	Turn-off time <sup>2)</sup> , max	$\mu$ s	125, 160, 200, 250, 320, 400, 500	$dv_D/dt = 50$ V/ $\mu$ s; $T_j = T_{j\max}$ ; $I_{TM} = I_{TAV}$ ; $di_R/dt = -10$ A/ $\mu$ s; $V_R = 100$ V; $V_D = 0.67 \cdot V_{DRM}$	
$Q_{rr}$	Total recovered charge, max	$\mu$ C	1100	$T_j = T_{j\max}$ ; $I_{TM} = 200$ A;	
$t_{rr}$	Reverse recovery time, max	$\mu$ s	20	$di_R/dt = -10$ A/ $\mu$ s;	
$I_{rrM}$	Peak reverse recovery current, max	A	110	$V_R = 100$ V	

<b>THERMAL</b>				
$R_{thjc}$	Thermal resistance, junction to case, max	$^{\circ}\text{C}/\text{W}$	0.0850	Direct current
<b>MECHANICAL</b>				
w	Weight, max	g	440	
$D_s$	Surface creepage distance	mm (inch)	12.40 (4.882)	
$D_a$	Air strike distance	mm (inch)	12.40 (4.882)	

<b>PART NUMBERING GUIDE</b>							<b>NOTES</b>																						
T	171	200	18	A2	E2	N	1) Critical rate of rise of off-state voltage																						
1	2	3	4	5	6	7	<table border="1"> <thead> <tr> <th>Symbol of Group</th> <th>P2</th> <th>K2</th> <th>E2</th> <th>A2</th> </tr> </thead> <tbody> <tr> <td><math>(dv_D/dt)_{crit}, \text{V}/\mu\text{s}</math></td> <td>200</td> <td>320</td> <td>500</td> <td>1000</td> </tr> </tbody> </table>							Symbol of Group	P2	K2	E2	A2	$(dv_D/dt)_{crit}, \text{V}/\mu\text{s}$	200	320	500	1000						
Symbol of Group	P2	K2	E2	A2																									
$(dv_D/dt)_{crit}, \text{V}/\mu\text{s}$	200	320	500	1000																									
1. Phase Control Thyristor 2. Design version 3. Mean on-state current, A 4. Voltage code 5. Critical rate of rise of off-state voltage, $\text{V}/\mu\text{s}$ 6. Turn-off time ( $dv_D/dt=50 \text{ V}/\mu\text{s}$ ) 7. Ambient conditions: N – normal; T – tropical							2) Turn-off time ( $dv_D/dt=50 \text{ V}/\mu\text{s}$ )																						
							<table border="1"> <thead> <tr> <th>Symbol of Group</th> <th>X2</th> <th>T2</th> <th>P2</th> <th>M2</th> <th>K2</th> <th>H2</th> <th>E2</th> </tr> </thead> <tbody> <tr> <td><math>t_q, \mu\text{s}</math></td> <td>125</td> <td>160</td> <td>200</td> <td>250</td> <td>320</td> <td>400</td> <td>500</td> </tr> </tbody> </table>							Symbol of Group	X2	T2	P2	M2	K2	H2	E2	$t_q, \mu\text{s}$	125	160	200	250	320	400	500
Symbol of Group	X2	T2	P2	M2	K2	H2	E2																						
$t_q, \mu\text{s}$	125	160	200	250	320	400	500																						

**OVERALL DIMENSIONS**

**Package type: T.SB1**

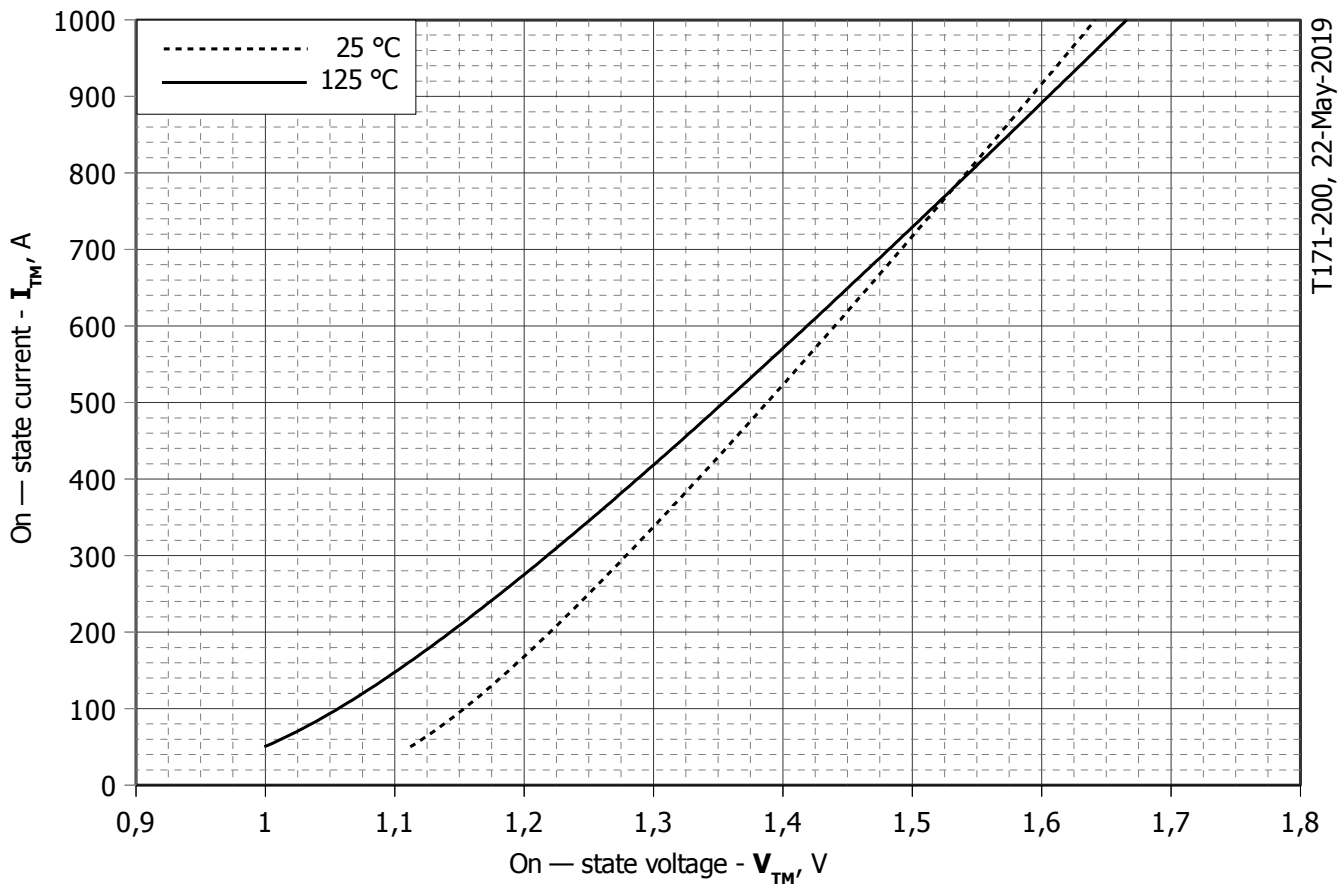


Type of screw	W	H
Metric Screw Type C	M24x1,5 – 8g	19
Metric Screw Type B (upon request)	M20x1,5 – 8g	15

Polarity	Example of code designation	Reference designation	Colors		
			Anode	Cathode	Gate
Anode to stud	T171-200-18		-	Red tube	White

All dimensions in millimeters (inches)

The information contained herein is confidential and protected by Copyright. In the interest of product improvement, Proton-Electrotex reserves the right to change data sheet without notice.



T171-200, 22-May-2019

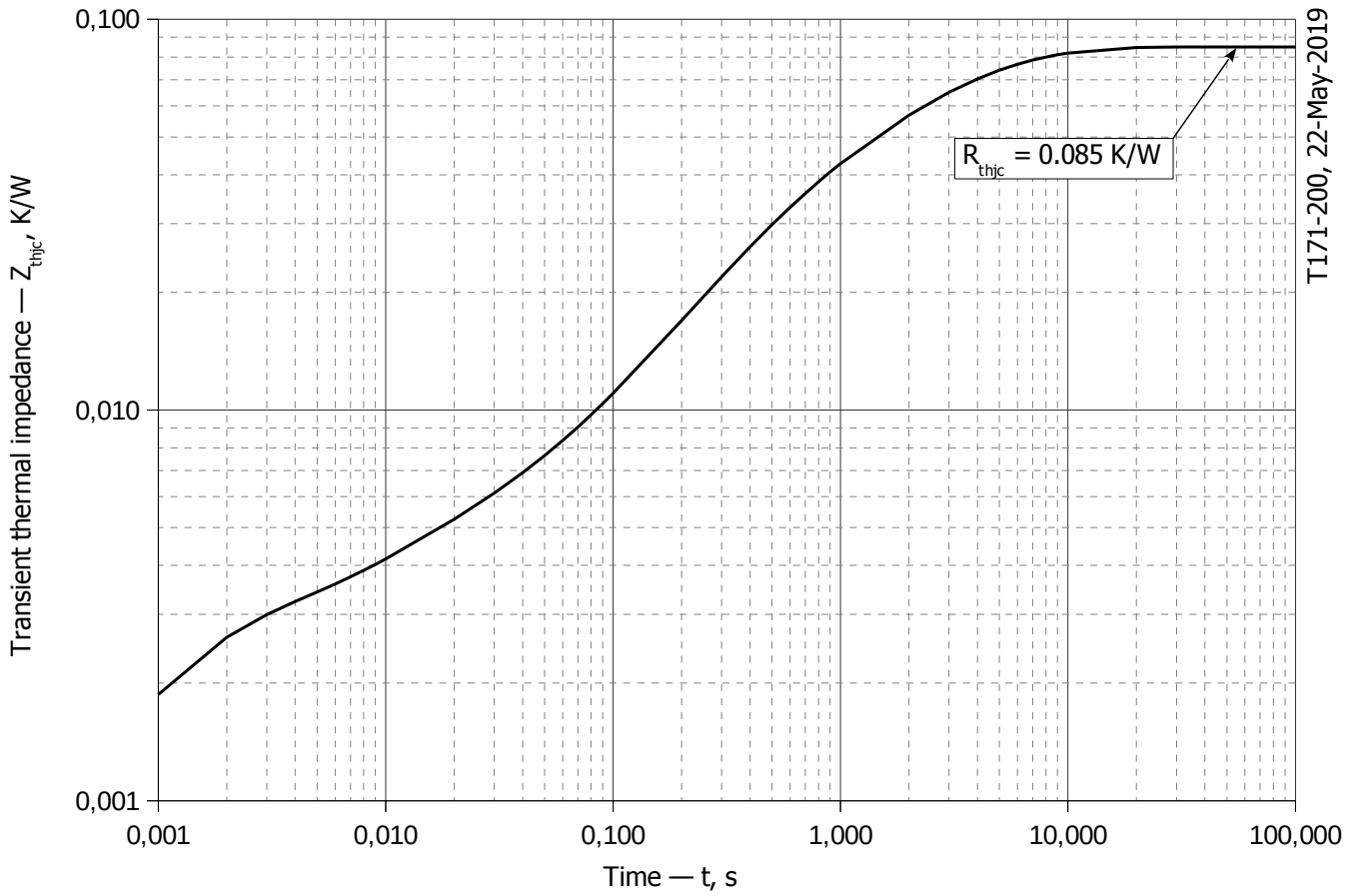
**Fig 1 – On-state characteristics of Limit device**

Analytical function for On-state characteristic:

$$V_T = A + B \cdot i_T + C \cdot \ln(i_T + 1) + D \cdot \sqrt{i_T}$$

	Coefficients for max curves	
	$T_j = 25^\circ\text{C}$	$T_j = T_{j\text{max}}$
<b>A</b>	0.99949000	0.82478000
<b>B</b>	0.00043774	0.00052351
<b>C</b>	0.01880300	0.03237500
<b>D</b>	0.00235370	0.00296790

**On-state characteristic model (see Fig. 1)**



**Fig 2 – Transient thermal impedance  $Z_{thjc}$  vs. time  $t$**

Analytical function for Transient thermal impedance junction to case  $Z_{thjc}$  for DC:

$$Z_{thjc} = \sum_{i=1}^n R_i \left( 1 - e^{-\frac{t}{\tau_i}} \right)$$

Where  $i = 1$  to  $n$ ,  $n$  is the number of terms in the series.

$t$  = Duration of heating pulse in seconds.

$Z_{thjc}$  = Thermal resistance at time  $t$ .

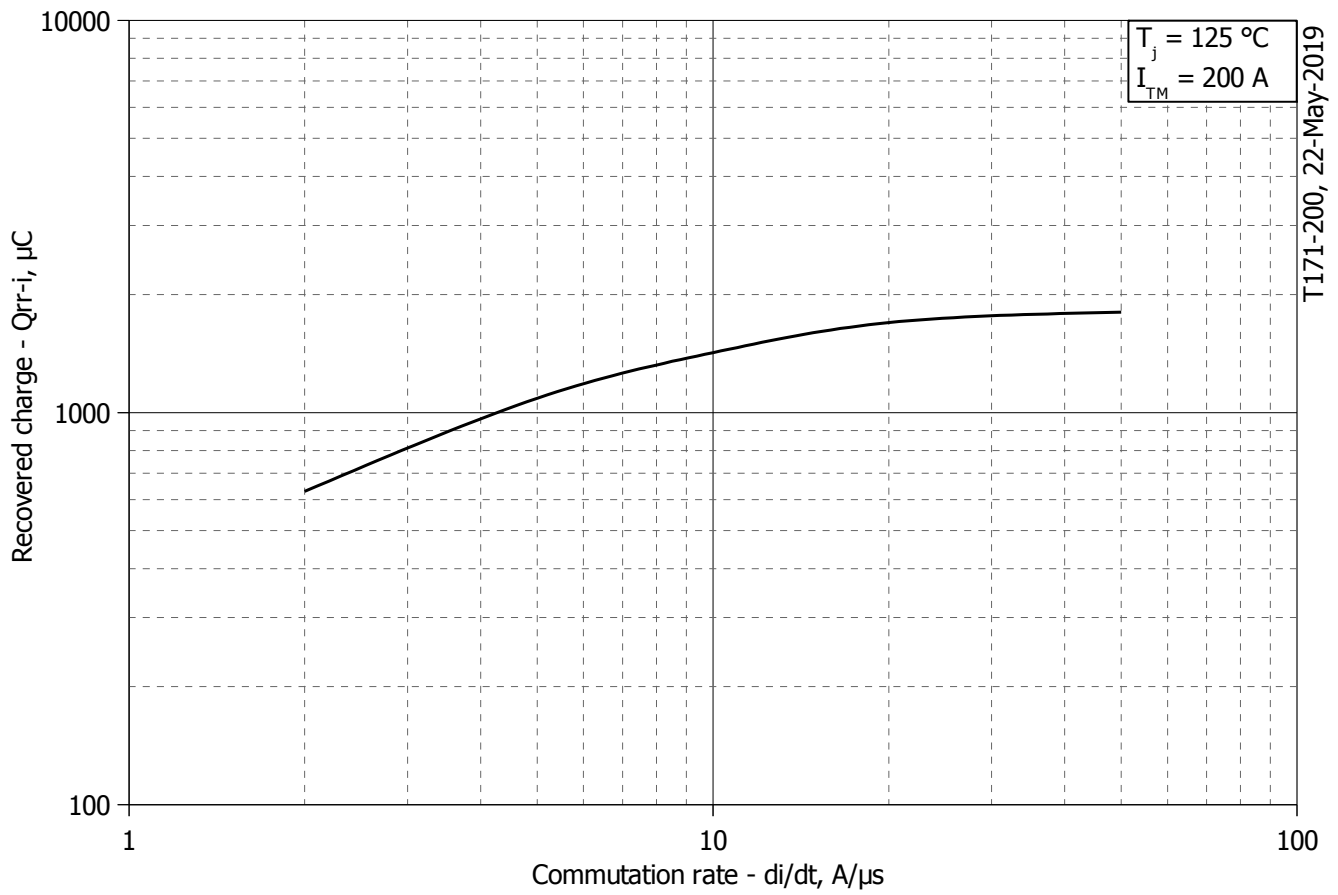
$R_i$  = Amplitude of  $p_{th}$  term.

$\tau_i$  = Time constant of  $r_{th}$  term.

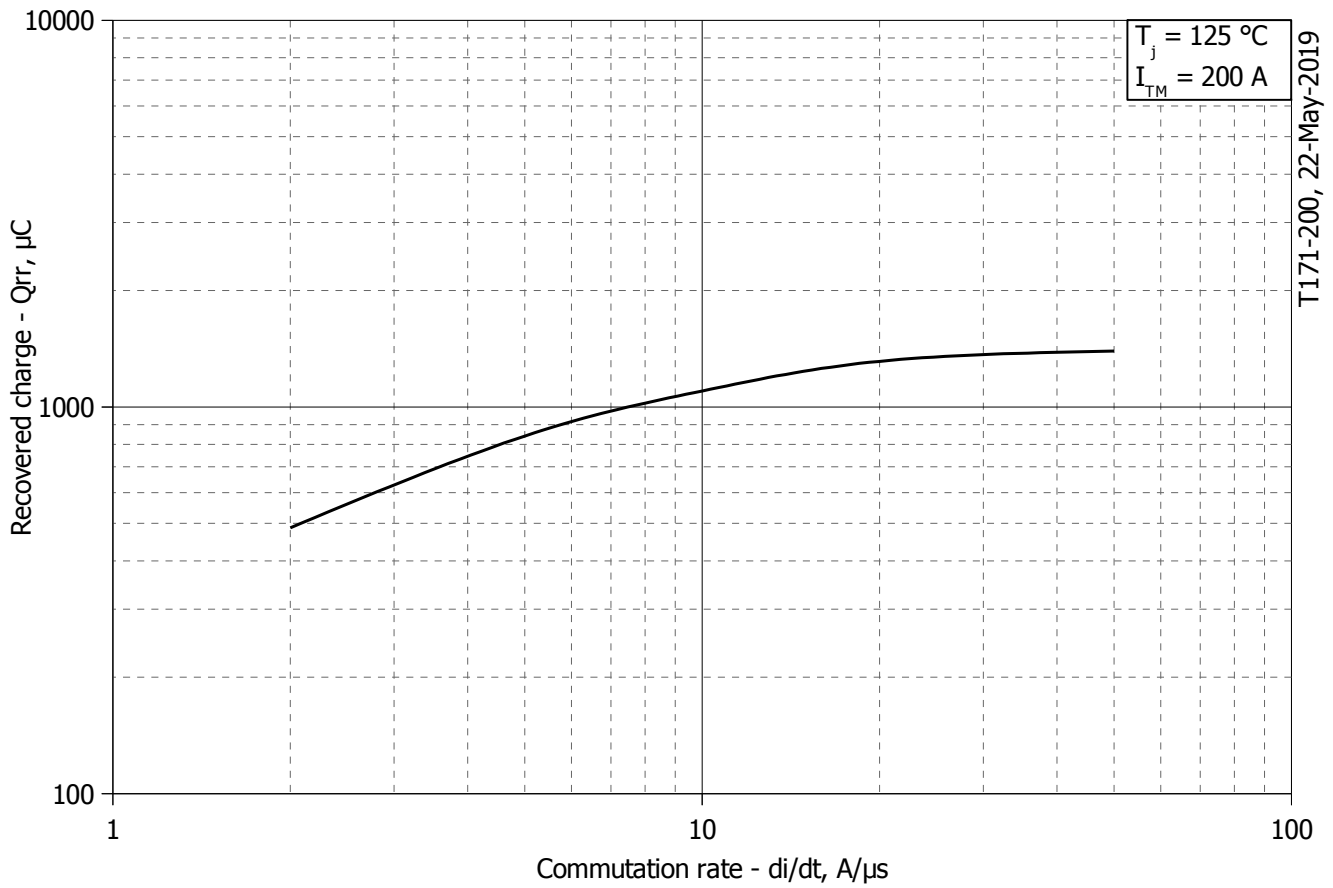
DC

<b>i</b>	<b>1</b>	<b>2</b>	<b>3</b>	<b>4</b>	<b>5</b>	<b>6</b>
<b><math>R_i</math>, K/W</b>	0.023357	0.02733	0.01495	0.001445	0.002488	0.01543
<b><math>\tau_i</math>, s</b>	4.627	2.249	0.3406	0.01043	0.0009112	0.9081

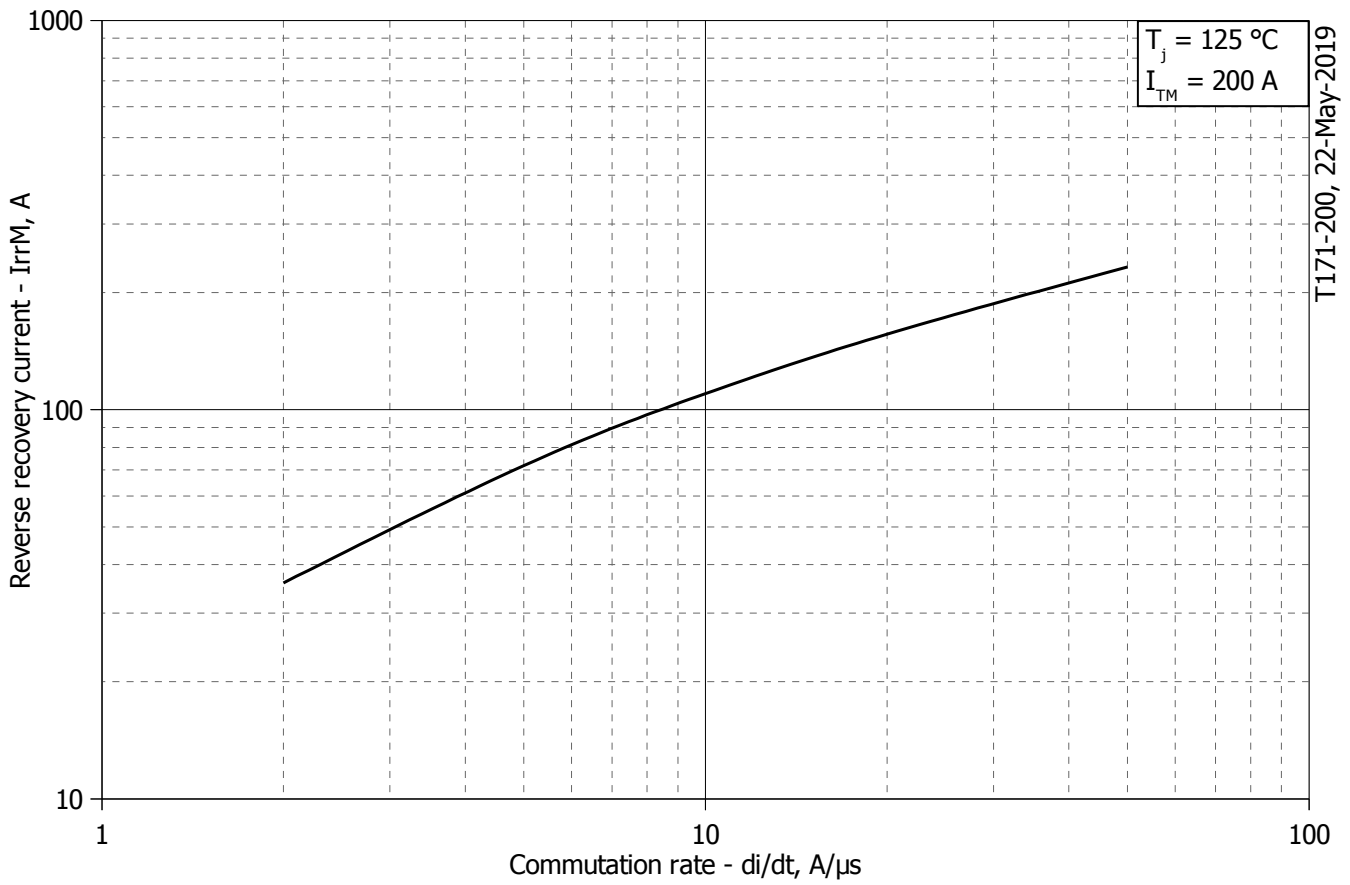
**Transient thermal impedance junction to case  $Z_{thjc}$  model (see Fig. 2)**



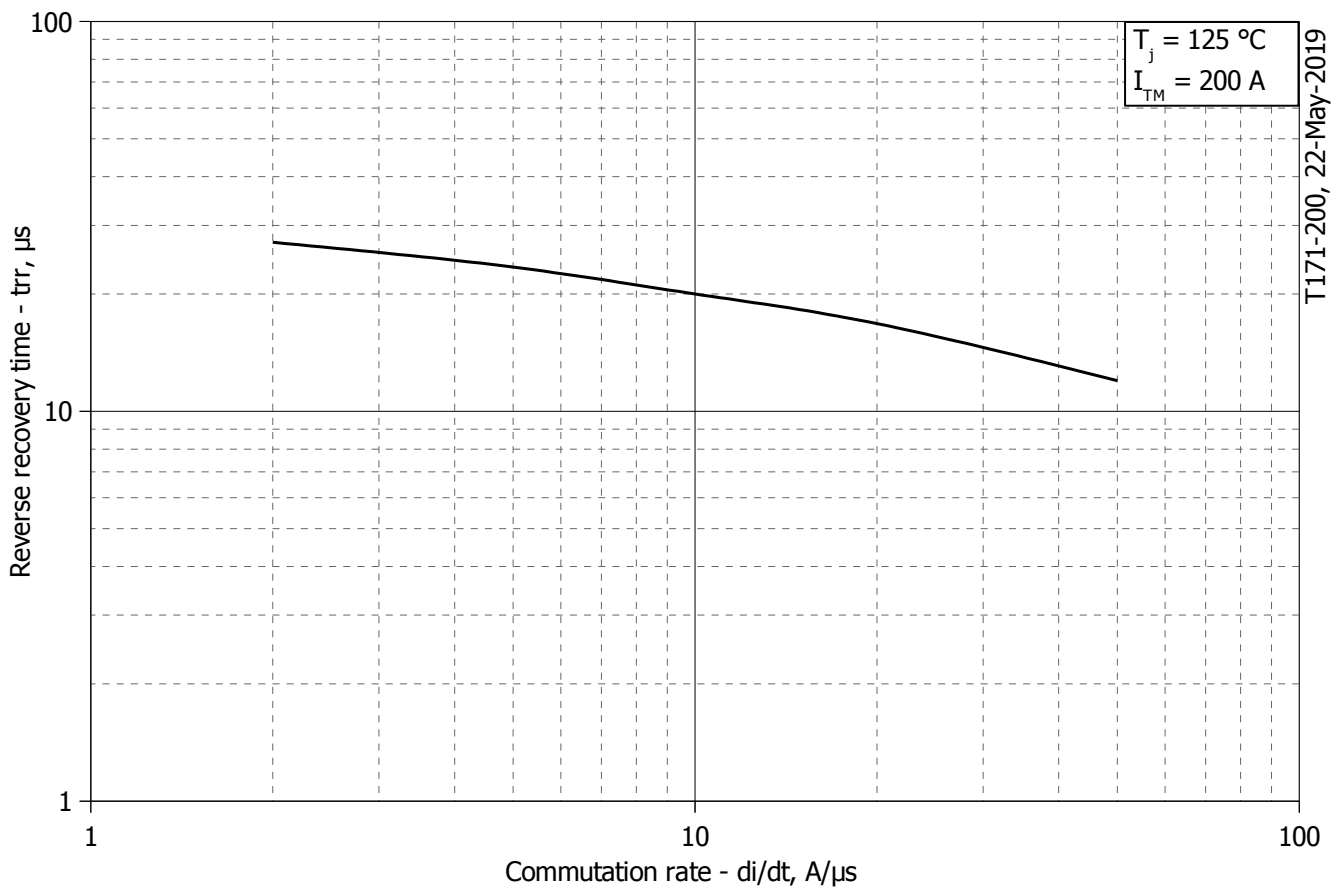
**Fig 3 – Maximum recovered charge  $Q_{rr-i}$  (integral) vs. commutation rate  $di_R/dt$**



**Fig 4 – Maximum recovered charge  $Q_{rr}$  vs. commutation rate  $di_R/dt$  (25% chord)**

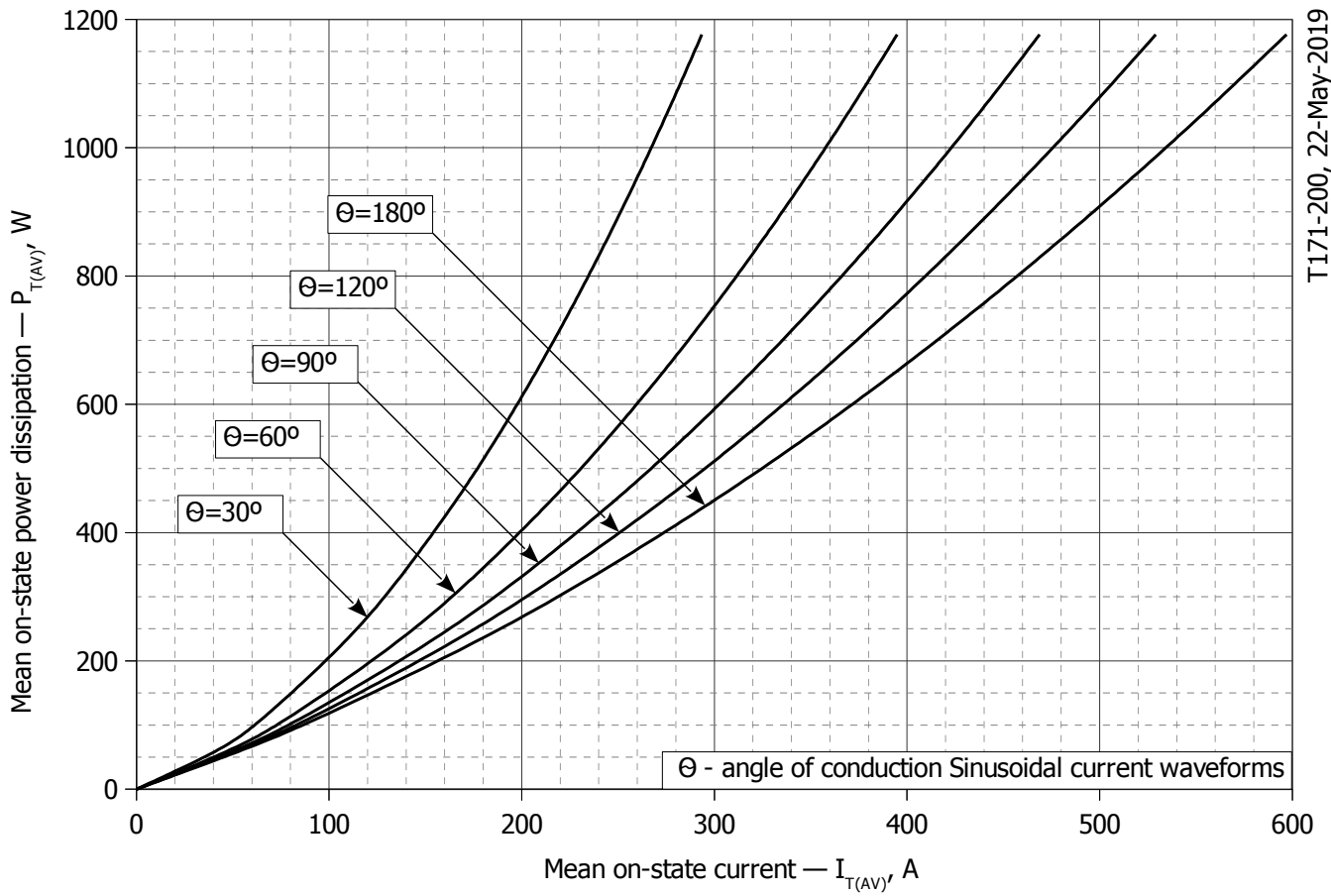


**Fig 5 – Maximum reverse recovery current  $I_{rrM}$  vs. commutation rate  $di_R/dt$**



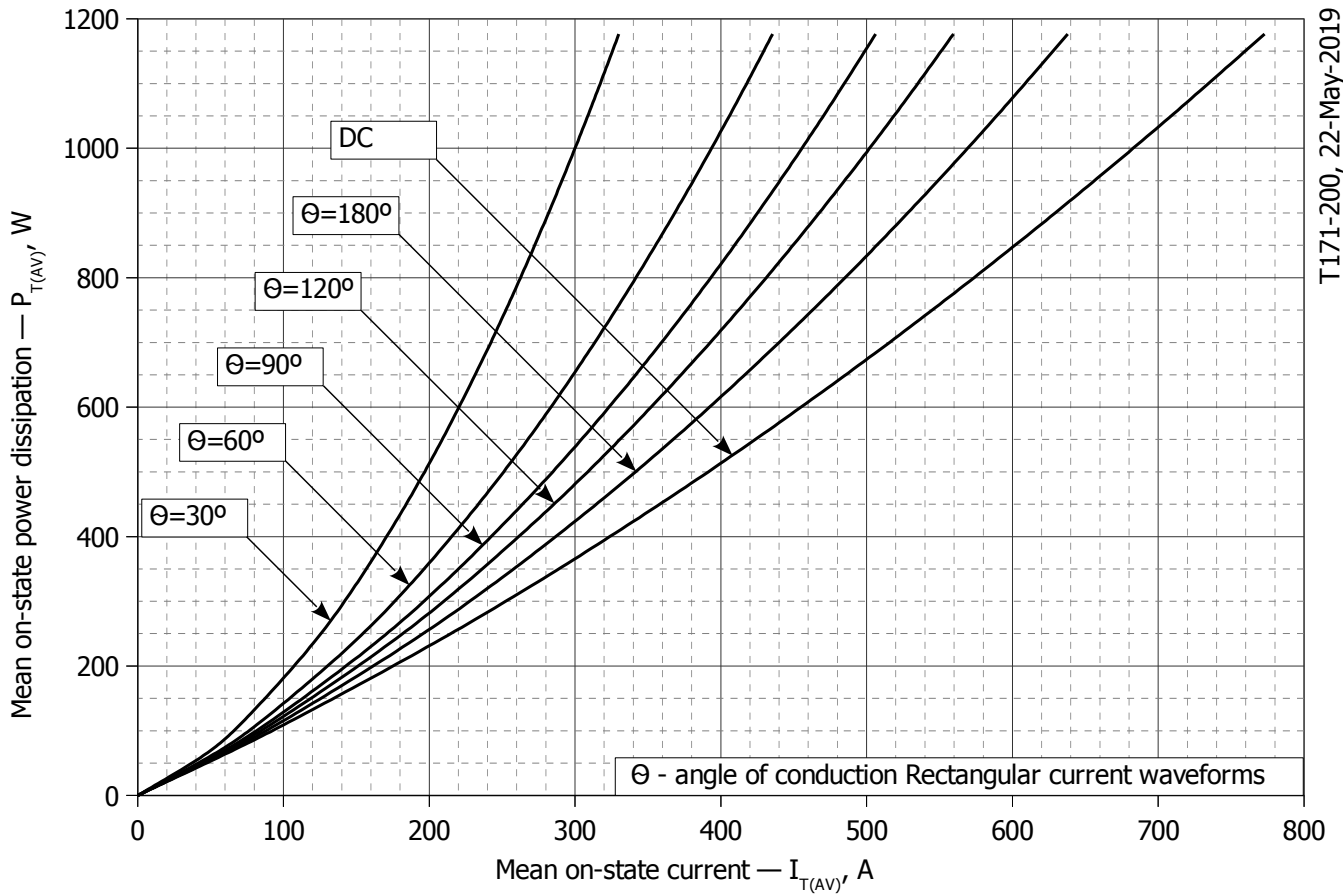
**Fig 6 – Maximum recovery time  $t_{rr}$  vs. commutation rate  $di_R/dt$  (25% chord)**





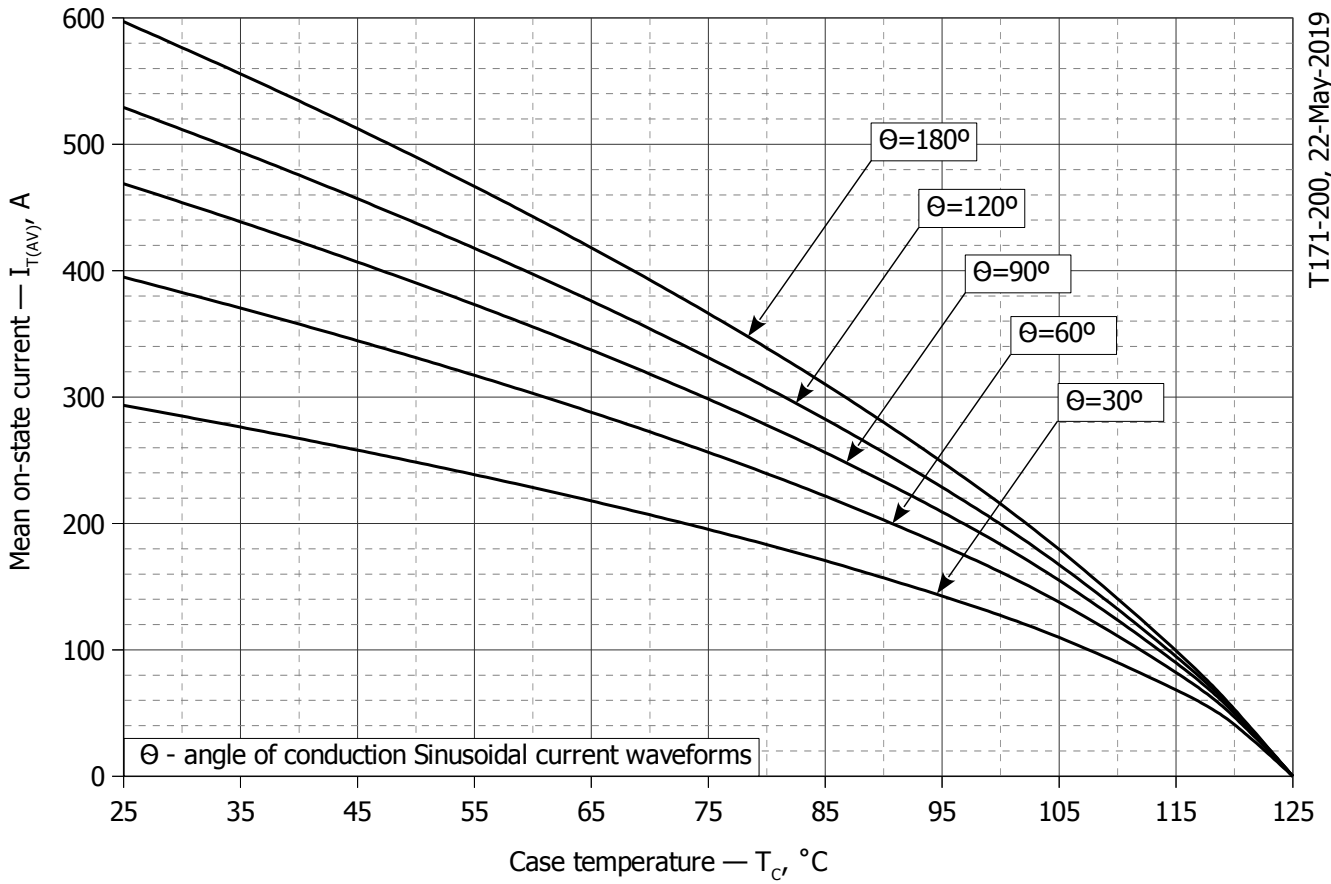
T171-200, 22-May-2019

**Fig. 7 - Mean on-state power dissipation  $P_{TAV}$  vs. mean on-state current  $I_{TAV}$  for sinusoidal current waveforms at different conduction angles ( $f=50\text{Hz}$ , DSC)**

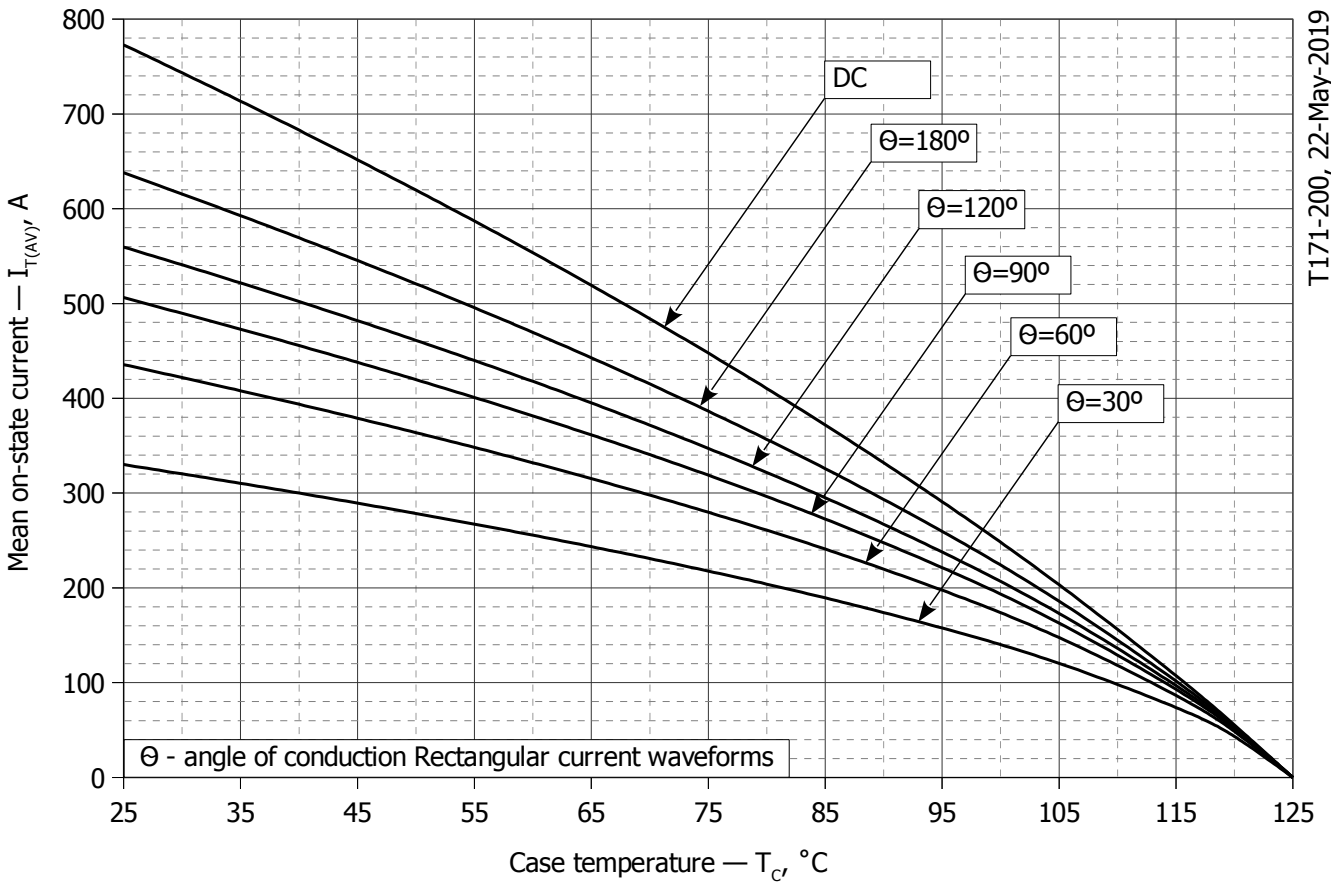


T171-200, 22-May-2019

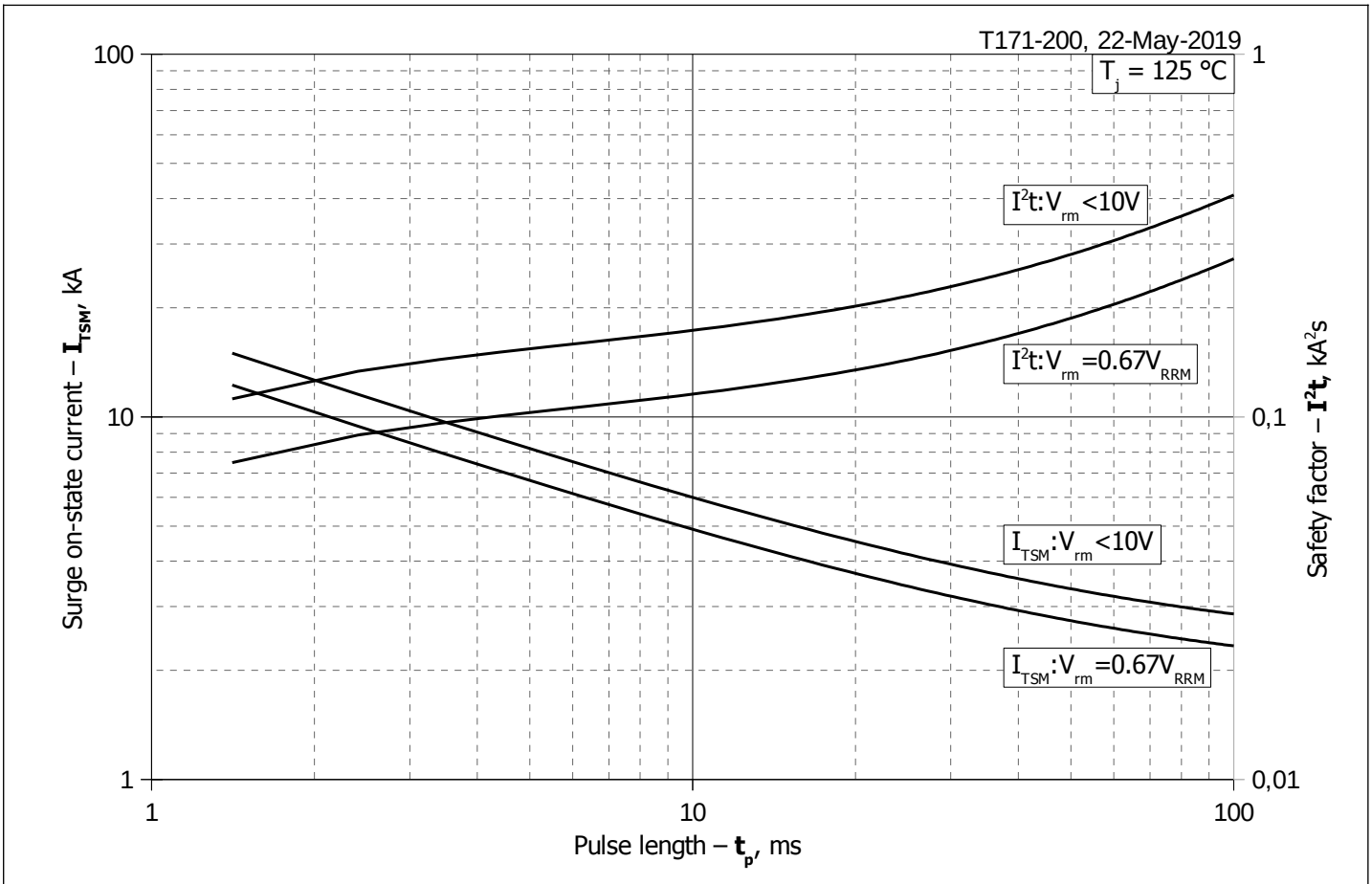
**Fig. 8 – Mean on-state power dissipation  $P_{TAV}$  vs. mean on-state current  $I_{TAV}$  for rectangular current waveforms at different conduction angles and for DC ( $f=50\text{Hz}$ , DSC)**



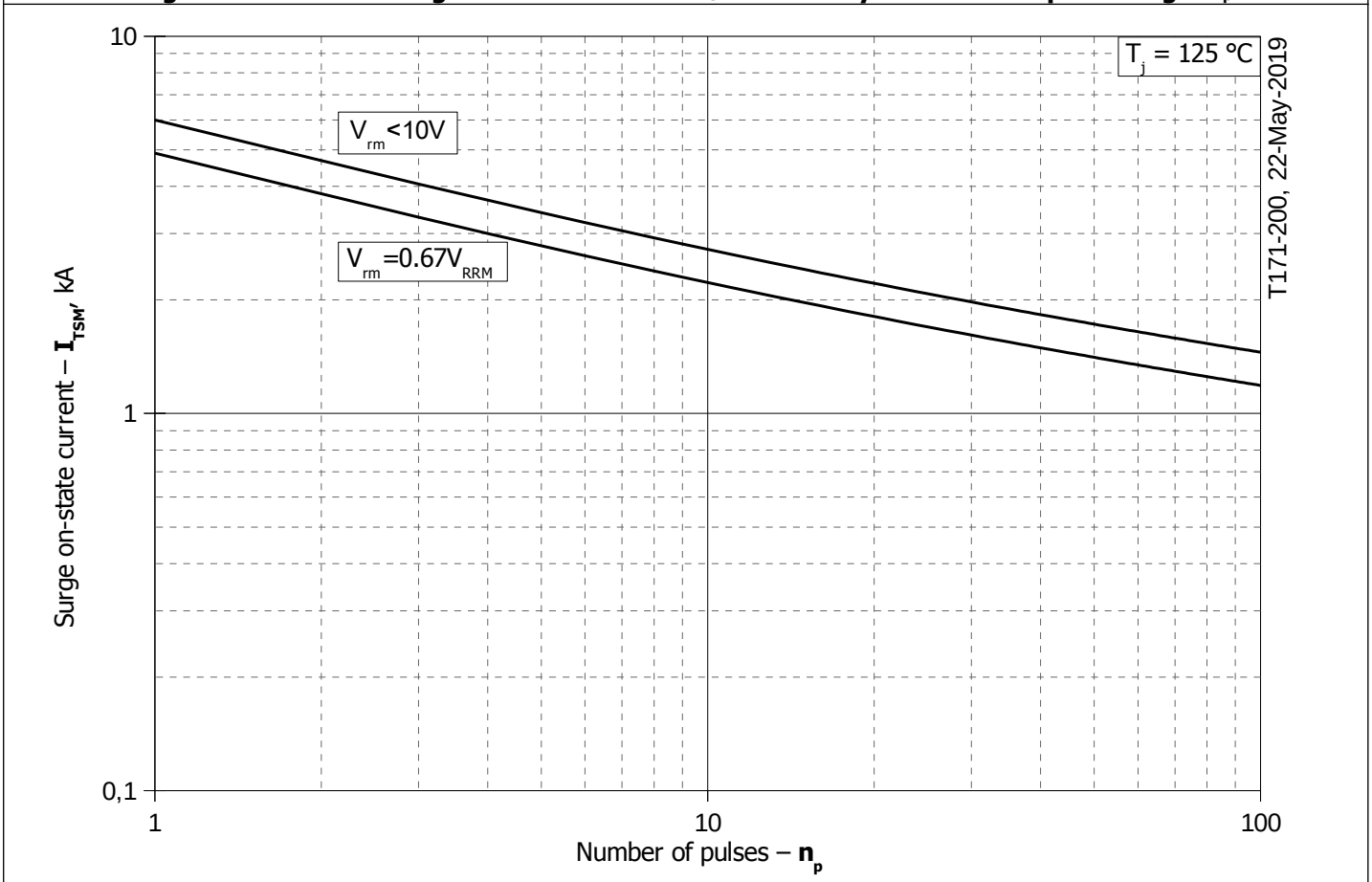
**Fig. 9 – Mean on-state current  $I_{TAV}$  vs. case temperature  $T_c$  for sinusoidal current waveforms at different conduction angles ( $f=50\text{Hz}$ , DSC)**



**Fig. 10 - Mean on-state current  $I_{TAV}$  vs. case temperature  $T_c$  for rectangular current waveforms at different conduction angles and for DC ( $f=50\text{Hz}$ , DSC)**



**Fig. 11 – Maximum surge on-state current  $I_{TSM}$  and safety factor  $I^2t$  vs. pulse length  $t_p$**



**Fig. 12 - Maximum surge on-state current  $I_{TSM}$  vs. number of pulses  $n_p$**