



High power cycling capability
Low on-state and switching losses
Designed for traction and industrial applications

Phase Control Thyristor Type T153-630-24

Mean on-state current	I_{TAV}	630 A	
Repetitive peak off-state voltage	V_{DRM}	2000 ÷ 2400 V	
Repetitive peak reverse voltage	V_{RRM}		
Turn-off time	t_q	320, 400, 500 μ s	
V_{DRM}, V_{RRM}, V	2000	2200	2400
Voltage code	20	22	24
$T_j, ^\circ C$	-60 ÷ 125		

MAXIMUM ALLOWABLE RATINGS

Symbols and parameters		Units	Values	Test conditions
ON-STATE				
I_{TAV}	Mean on-state current	A	630 1226	$T_c=109^\circ C$, Double side cooled $T_c=85^\circ C$, Double side cooled 180° half-sine wave; 50 Hz
I_{TRMS}	RMS on-state current	A	989	$T_c=109^\circ C$, Double side cooled 180° half-sine wave; 50 Hz
I_{TSM}	Surge on-state current	kA	28.0 32.0	$T_j=T_{j\ max}$ $T_j=25^\circ C$ 180° half-sine wave; $t_p=10\ ms$; single pulse; $V_D=V_R=0\ V$; Gate pulse: $I_G=2\ A$; $t_{GP}=50\ \mu s$; $di_G/dt \geq 1\ A/\mu s$
			29.0 33.0	$T_j=T_{j\ max}$ $T_j=25^\circ C$ 180° half-sine wave; $t_p=8.3\ ms$; single pulse; $V_D=V_R=0\ V$; Gate pulse: $I_G=2\ A$; $t_{GP}=50\ \mu s$; $di_G/dt \geq 1\ A/\mu s$
I^2t	Safety factor	$A^2s \cdot 10^3$	3900 5100	$T_j=T_{j\ max}$ $T_j=25^\circ C$ 180° half-sine wave; $t_p=10\ ms$; single pulse; $V_D=V_R=0\ V$; Gate pulse: $I_G=2\ A$; $t_{GP}=50\ \mu s$; $di_G/dt \geq 1\ A/\mu s$
			3400 4500	$T_j=T_{j\ max}$ $T_j=25^\circ C$ 180° half-sine wave; $t_p=8.3\ ms$; single pulse; $V_D=V_R=0\ V$; Gate pulse: $I_G=2\ A$; $t_{GP}=50\ \mu s$; $di_G/dt \geq 1\ A/\mu s$
BLOCKING				
V_{DRM}, V_{RRM}	Repetitive peak off-state and Repetitive peak reverse voltages	V	2000 ÷ 2400	$T_{j\ min} < T_j < T_{j\ max}$; 180° half-sine wave; 50 Hz; Gate open
V_{DSM}, V_{RSM}	Non-repetitive peak off-state and Non-repetitive peak reverse voltages	V	2100 ÷ 2500	$T_{j\ min} < T_j < T_{j\ max}$; 180° half-sine wave; single pulse; Gate open
V_D, V_R	Direct off-state and Direct reverse voltages	V	$0.6 \cdot V_{DRM}$ $0.6 \cdot V_{RRM}$	$T_j=T_{j\ max}$; Gate open

TRIGGERING				
I_{FGM}	Peak forward gate current	A	8	$T_j = T_{j\ max}$
V_{RGM}	Peak reverse gate voltage	V	5	
P_G	Gate power dissipation	W	4	$T_j = T_{j\ max}$ for DC gate current
SWITCHING				
$(di_T/dt)_{crit}$	Critical rate of rise of on-state current non-repetitive ($f=1\ Hz$)	A/ μs	2000	$T_j = T_{j\ max}$; $V_D = 0.67 \cdot V_{DRM}$; $I_{TM} = 2500\ A$; Gate pulse: $I_G = 2\ A$; $t_{GP} = 50\ \mu s$; $di_G/dt \geq 2\ A/\mu s$
THERMAL				
T_{stg}	Storage temperature	$^{\circ}C$	-60÷50	
T_j	Operating junction temperature	$^{\circ}C$	-60÷125	
MECHANICAL				
F	Mounting force	kN	24.0÷28.0	
a	Acceleration	m/s ²	50	Device clamped

CHARACTERISTICS

Symbols and parameters		Units	Values	Conditions	
ON-STATE					
V_{TM}	Peak on-state voltage, max	V	1.50	$T_j = 25\ ^{\circ}C$; $I_{TM} = 1978\ A$	
$V_{T(TO)}$	On-state threshold voltage, max	V	0.933	$T_j = T_{j\ max}$;	
r_T	On-state slope resistance, max	m Ω	0.292	$0.5\ \pi\ I_{TAV} < I_T < 1.5\ \pi\ I_{TAV}$	
I_L	Latching current, max	mA	1500	$T_j = 25\ ^{\circ}C$; $V_D = 12\ V$; Gate pulse: $I_G = 2\ A$; $t_{GP} = 50\ \mu s$; $di_G/dt \geq 1\ A/\mu s$	
I_H	Holding current, max	mA	300	$T_j = 25\ ^{\circ}C$; $V_D = 12\ V$; Gate open	
BLOCKING					
I_{DRM}, I_{RRM}	Repetitive peak off-state and Repetitive peak reverse currents, max	mA	150	$T_j = T_{j\ max}$; $V_D = V_{DRM}$; $V_R = V_{RRM}$	
$(dv_D/dt)_{crit}$	Critical rate of rise of off-state voltage ¹⁾ , min	V/ μs	200, 320, 500, 1000, 1600, 2000, 2500	$T_j = T_{j\ max}$; $V_D = 0.67 \cdot V_{DRM}$; Gate open	
TRIGGERING					
V_{GT}	Gate trigger direct voltage, max	V	3.00 2.50 1.50	$T_j = T_{j\ min}$ $T_j = 25\ ^{\circ}C$ $T_j = T_{j\ max}$	$V_D = 12\ V$; $I_D = 3\ A$; Direct gate current
I_{GT}	Gate trigger direct current, max	mA	400 250 150	$T_j = T_{j\ min}$ $T_j = 25\ ^{\circ}C$ $T_j = T_{j\ max}$	
V_{GD}	Gate non-trigger direct voltage, min	V	0.40	$T_j = T_{j\ max}$;	
I_{GD}	Gate non-trigger direct current, min	mA	40.00	$V_D = 0.67 \cdot V_{DRM}$; Direct gate current	
SWITCHING					
t_{gd}	Delay time	μs	1.00	$T_j = 25\ ^{\circ}C$; $V_D = 1000\ V$; $I_{TM} = I_{TAV}$; $di/dt = 200\ A/\mu s$;	
t_{gt}	Turn-on time, max	μs	5.00	Gate pulse: $I_G = 2\ A$; $V_G = 20\ V$; $t_{GP} = 50\ \mu s$; $di_G/dt = 2\ A/\mu s$	
t_q	Turn-off time ²⁾ , max	μs	320, 400, 500	$dv_D/dt = 50\ V/\mu s$; $T_j = T_{j\ max}$; $I_{TM} = I_{TAV}$; $di_R/dt = -10\ A/\mu s$; $V_R = 100V$; $V_D = 0.67 \cdot V_{DRM}$	
Q_{rr}	Total recovered charge, max	μC	3150	$T_j = T_{j\ max}$; $I_{TM} = I_{TAV}$;	
t_{rr}	Reverse recovery time, typ	μs	35	$di_R/dt = -10\ A/\mu s$;	
I_{rrM}	Peak reverse recovery current, max	A	180	$V_R = 100\ V$;	

THERMAL					
R_{thjc}	Thermal resistance, junction to case, max	°C/W	0.0180	Direct current	Double side cooled
R_{thjc-A}			0.0396		Anode side cooled
R_{thjc-K}			0.0324		Cathode side cooled
R_{thck}	Thermal resistance, case to heatsink, max	°C/W	0.0040	Direct current	
MECHANICAL					
w	Weight, max	g	510		
D_s	Surface creepage distance	mm (inch)	30.38 (1.196)		
D_a	Air strike distance	mm (inch)	18.05 (0.710)		

PART NUMBERING GUIDE							NOTES							
T	153	630	24	A2	E2	N	¹⁾ Critical rate of rise of off-state voltage							
1	2	3	4	5	6	7	Symbol of Group	P2	K2	E2	A2	T1	P1	M1
1. Phase Control Thyristor 2. Design version 3. Mean on-state current, A 4. Voltage code 5. Critical rate of rise of off-state voltage, V/μs 6. Turn-off time ($dv_D/dt=50$ V/μs) 7. Ambient conditions: N – normal; T – tropical							$(dv_D/dt)_{crit}$, V/μs	200	320	500	1000	1600	2000	2500
							²⁾ Turn-off time ($dv_D/dt=50$ V/μs)							
							Symbol of Group	K2		H2		E2		
							t_q , μs	320		400		500		

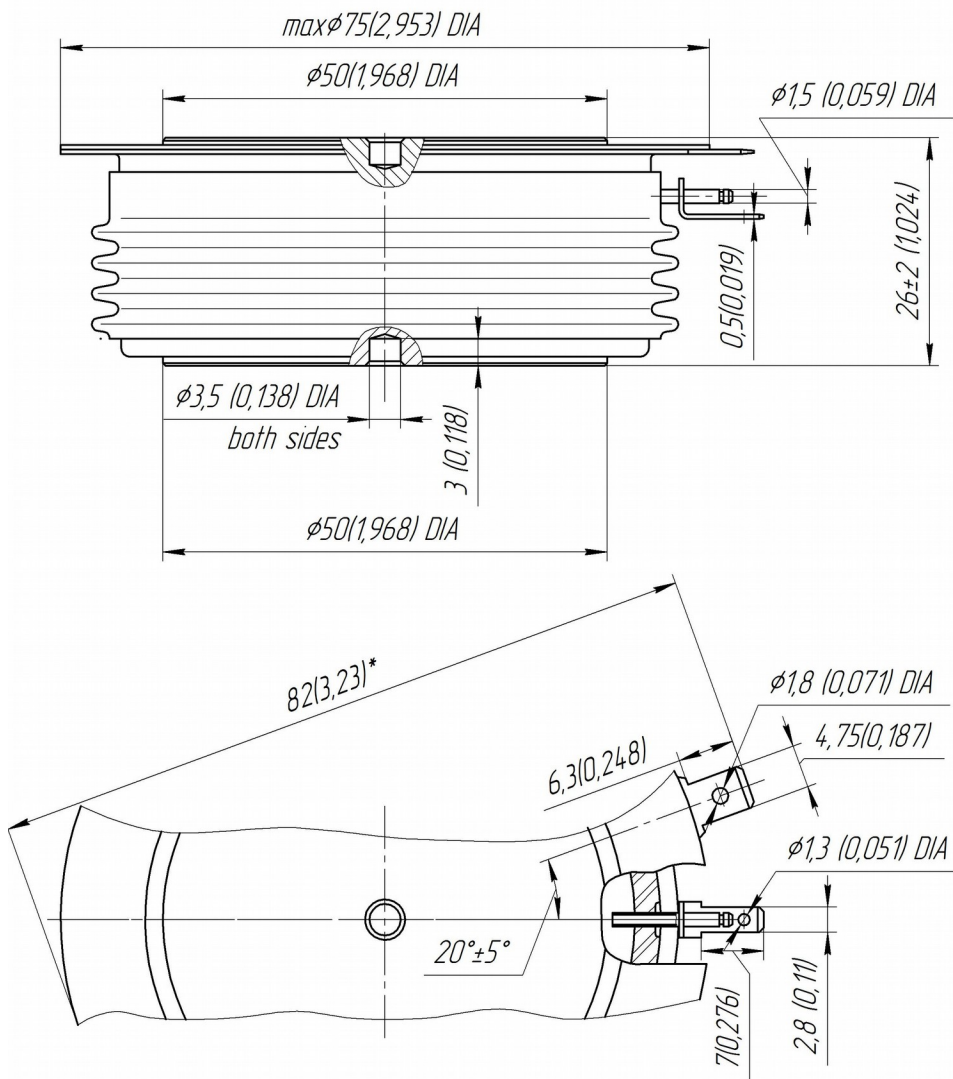

All dimensions in millimeters (inches)

The information contained herein is confidential and protected by Copyright. In the interest of product improvement, Proton-Electrotex reserves the right to change data sheet without notice.

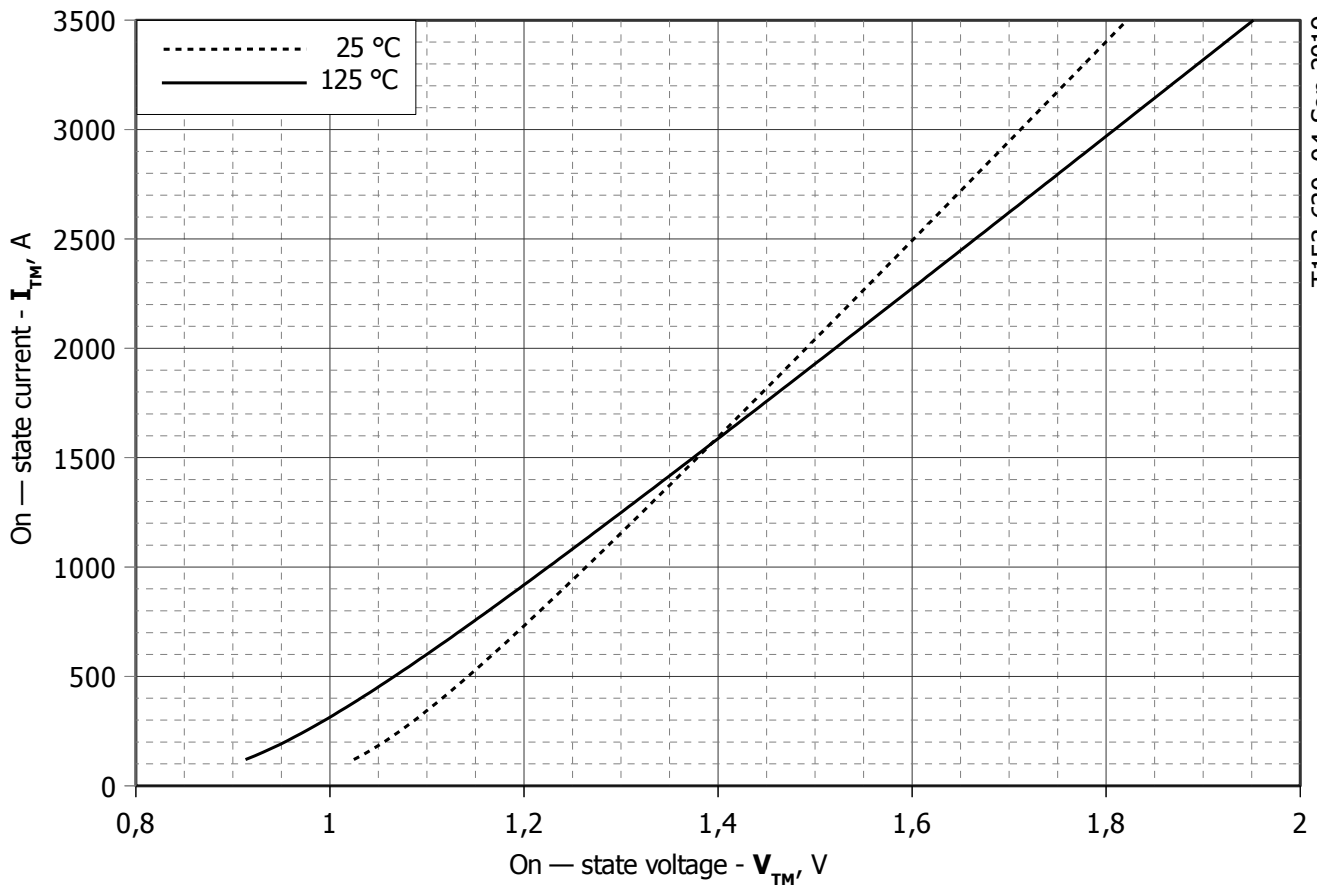

Fig 1 – On-state characteristics of Limit device

Analytical function for On-state characteristic:

$$V_T = A + B \cdot i_T + C \cdot \ln(i_T + 1) + D \cdot \sqrt{i_T}$$

	Coefficients for max curves	
	$T_j = 25^\circ\text{C}$	$T_j = T_{j,max}$
A	0.84625000	0.68019000
B	0.00022082	0.00028804
C	0.03484300	0.04553000
D	-0.00138500	-0.00182710

On-state characteristic model (see Fig. 1)

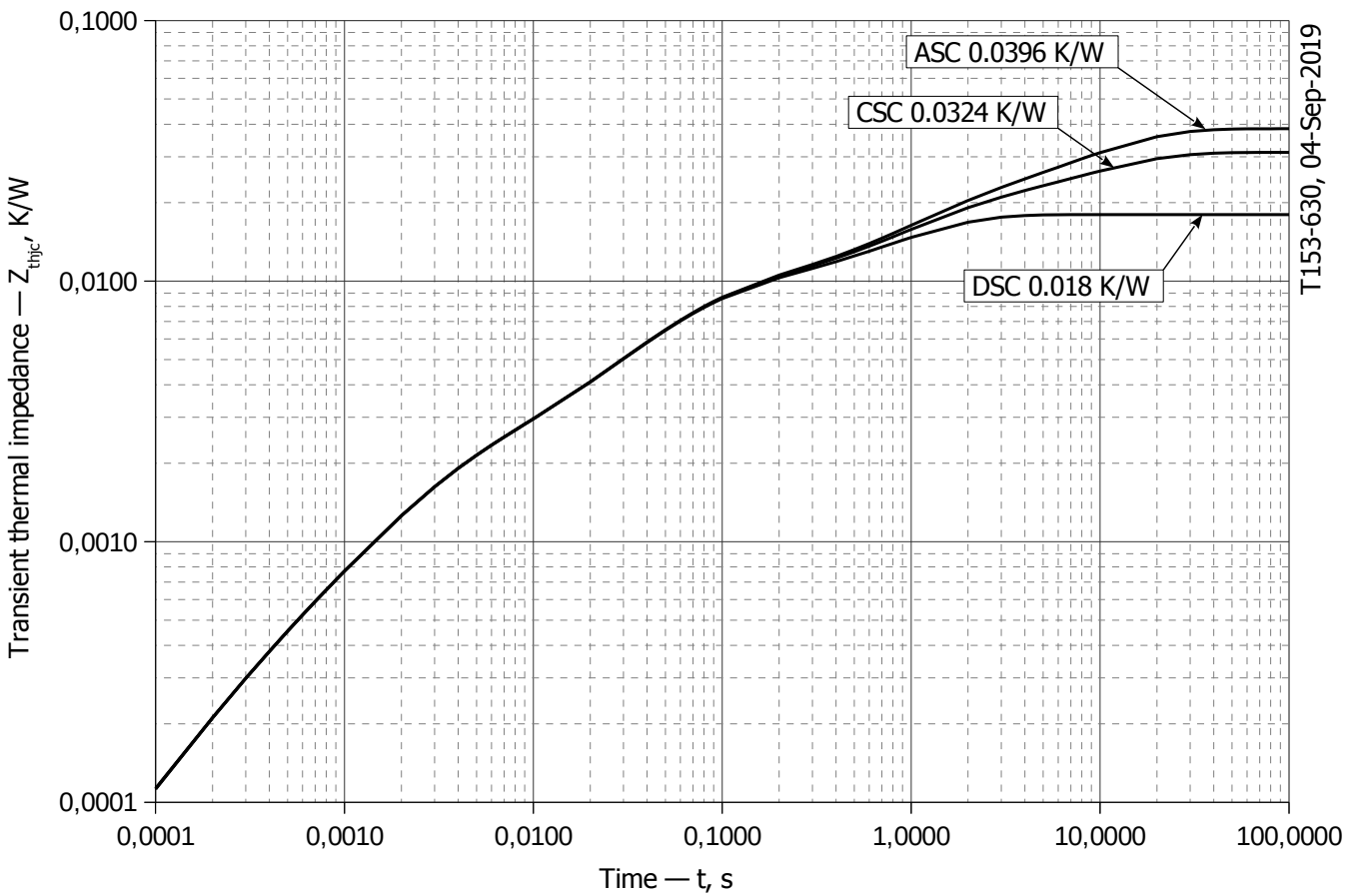

T153-630, 04-Sep-2019

Fig 2 – Transient thermal impedance Z_{thjc} vs. time t

Analytical function for Transient thermal impedance junction to case Z_{thjc} for DC:

$$Z_{thjc} = \sum_{i=1}^n R_i \left(1 - e^{-\frac{t}{\tau_i}} \right)$$

Where $i = 1$ to n , n is the number of terms in the series.

t = Duration of heating pulse in seconds.

Z_{thjc} = Thermal resistance at time t .

R_i = Amplitude of p_{th} term.

τ_i = Time constant of r_{th} term.

DC Double side cooled

i	1	2	3	4	5	6
R_i , K/W	0.009241	0.006037	0.001231	0.001054	0.0003396	0.00009575
τ_i , s	0.9673	0.04967	0.002733	0.07734	0.001638	0.0002248

DC Anode side cooled

i	1	2	3	4	5	6
R_i , K/W	0.01318	0.009281	0.006055	0.001018	0.001535	0.0001182
τ_i , s	9.745	1.028	0.05591	0.03732	0.002468	0.0002687

DC Cathode side cooled

i	1	2	3	4	5	6
R_i , K/W	0.02041	0.009325	0.006949	0.0001252	0.001516	0.0001119
τ_i , s	9.752	1.065	0.05344	0.01407	0.002421	0.0002554

Transient thermal impedance junction to case Z_{thjc} model (see Fig. 2)

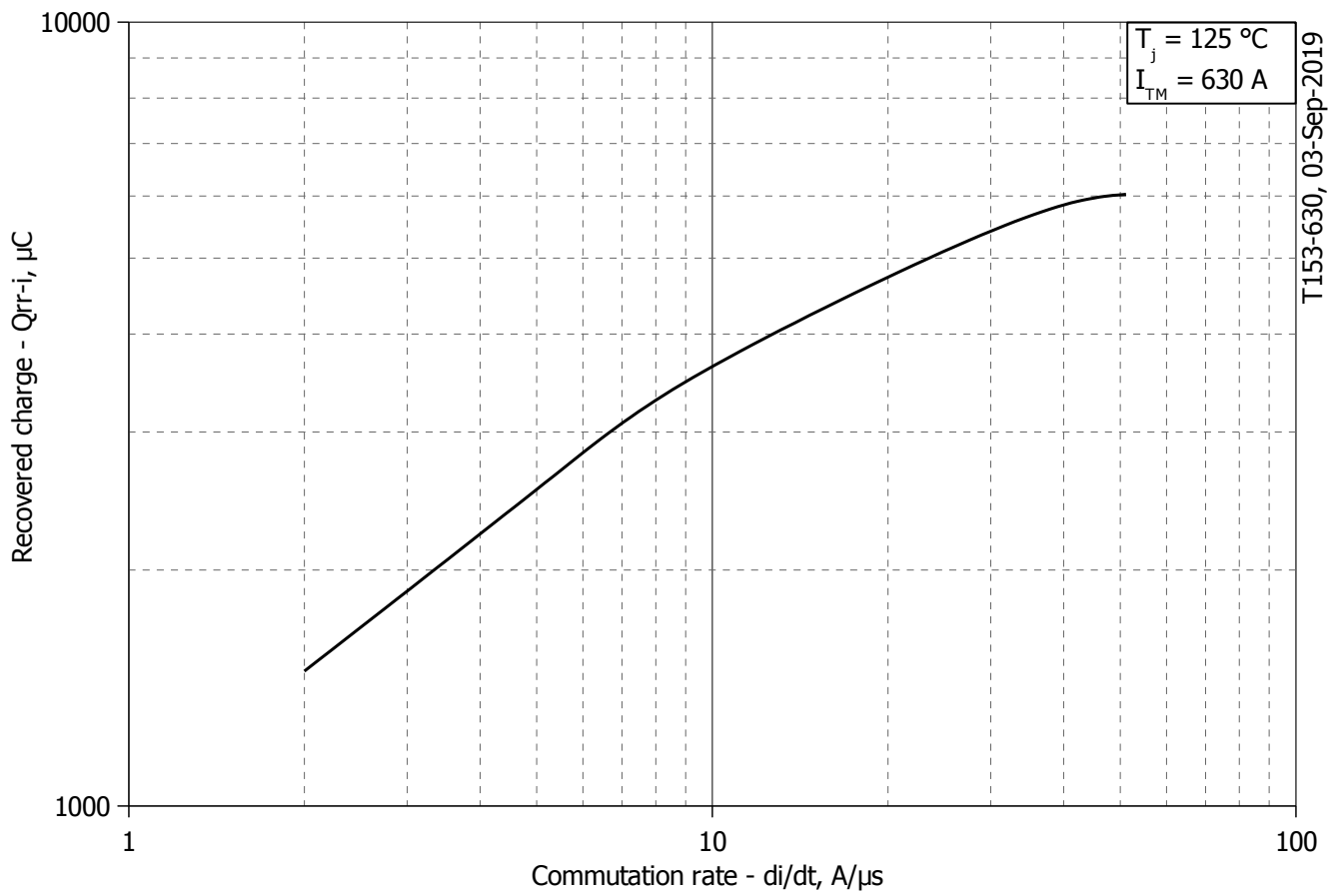

Fig 3 – Maximum recovered charge Q_{rr-i} (integral) vs. commutation rate di_R/dt

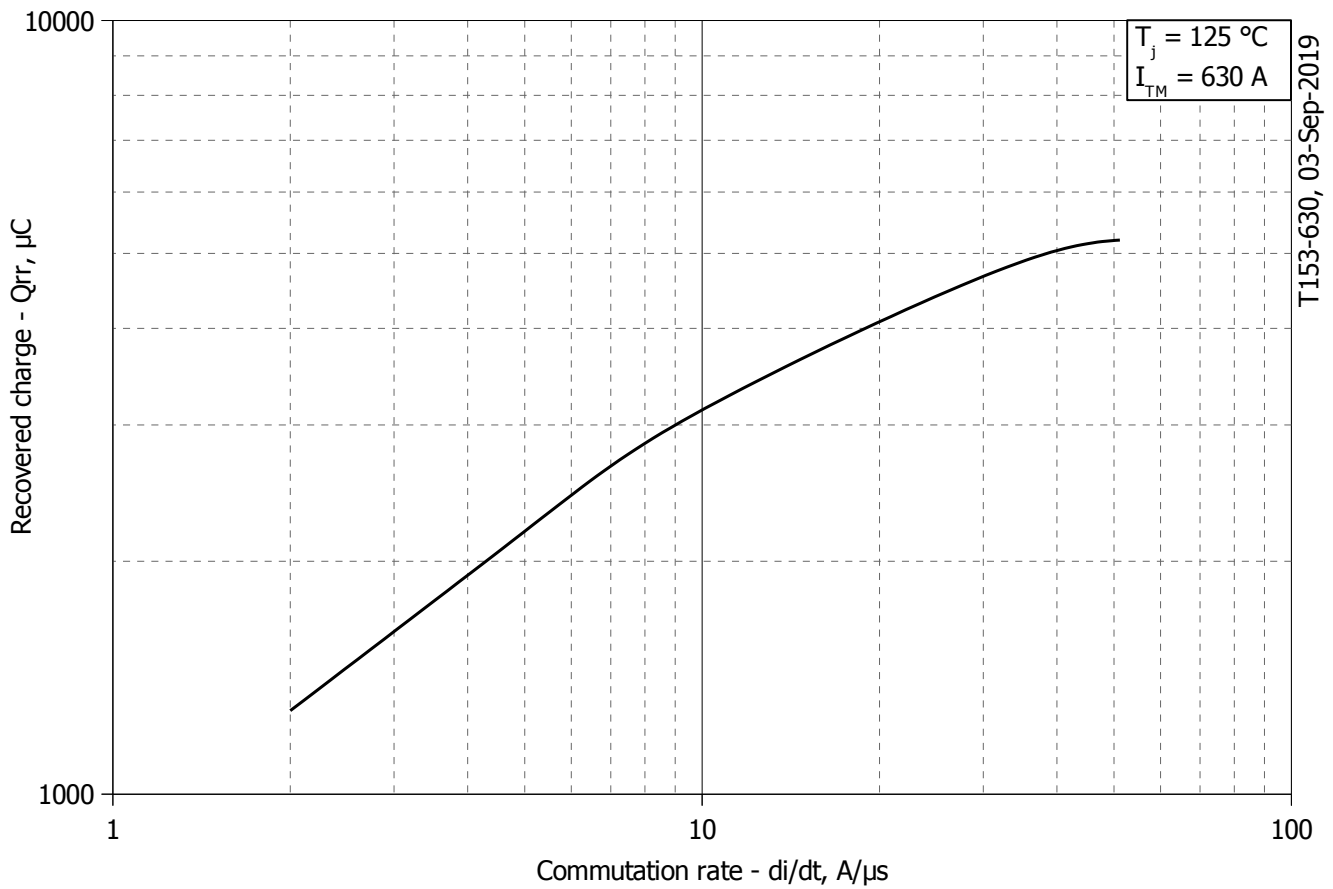

Fig 4 – Maximum recovered charge Q_{rr} vs. commutation rate di_R/dt (25% chord)

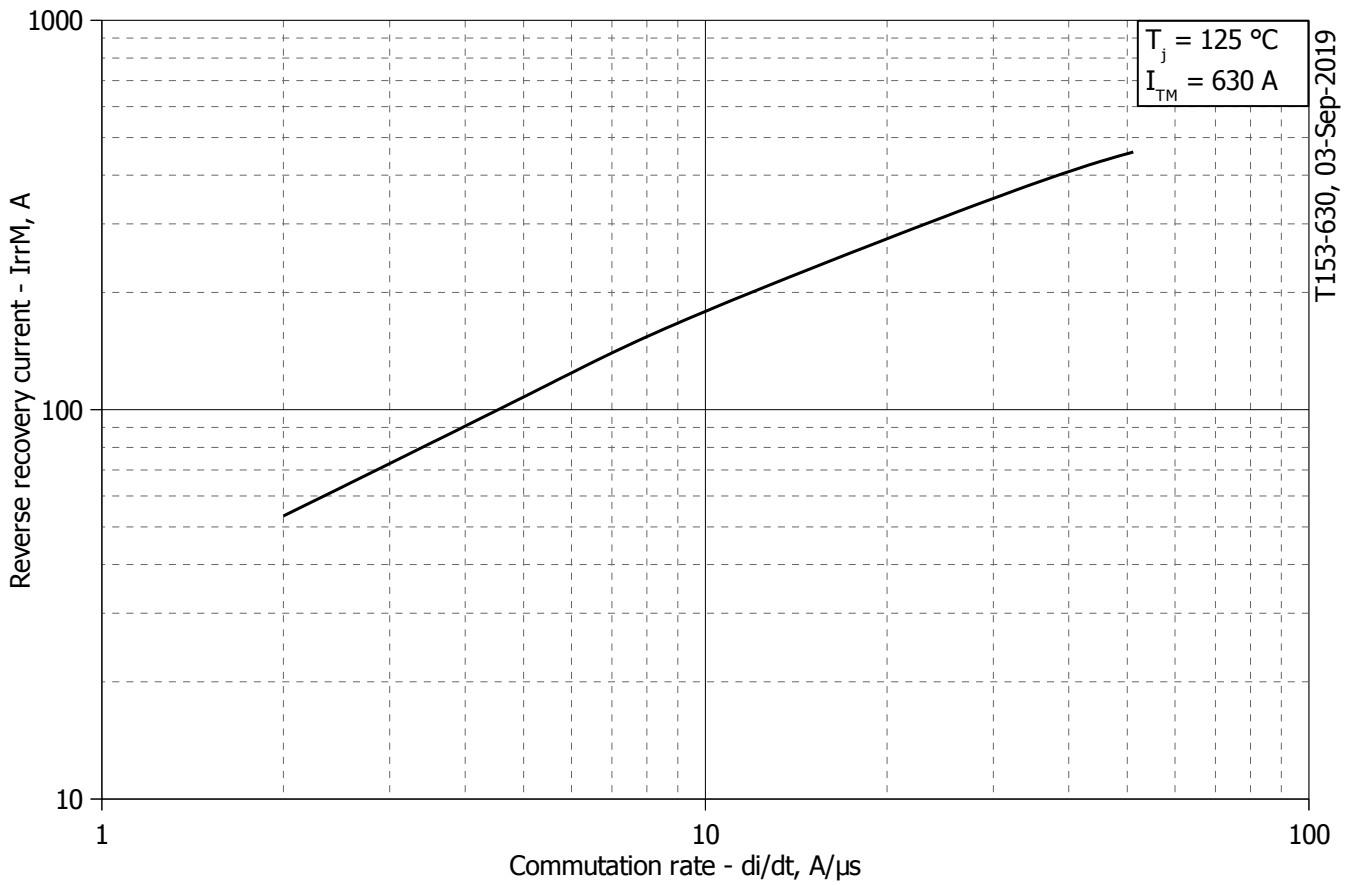

Fig 5 – Maximum reverse recovery current I_{rrM} vs. commutation rate di_R/dt

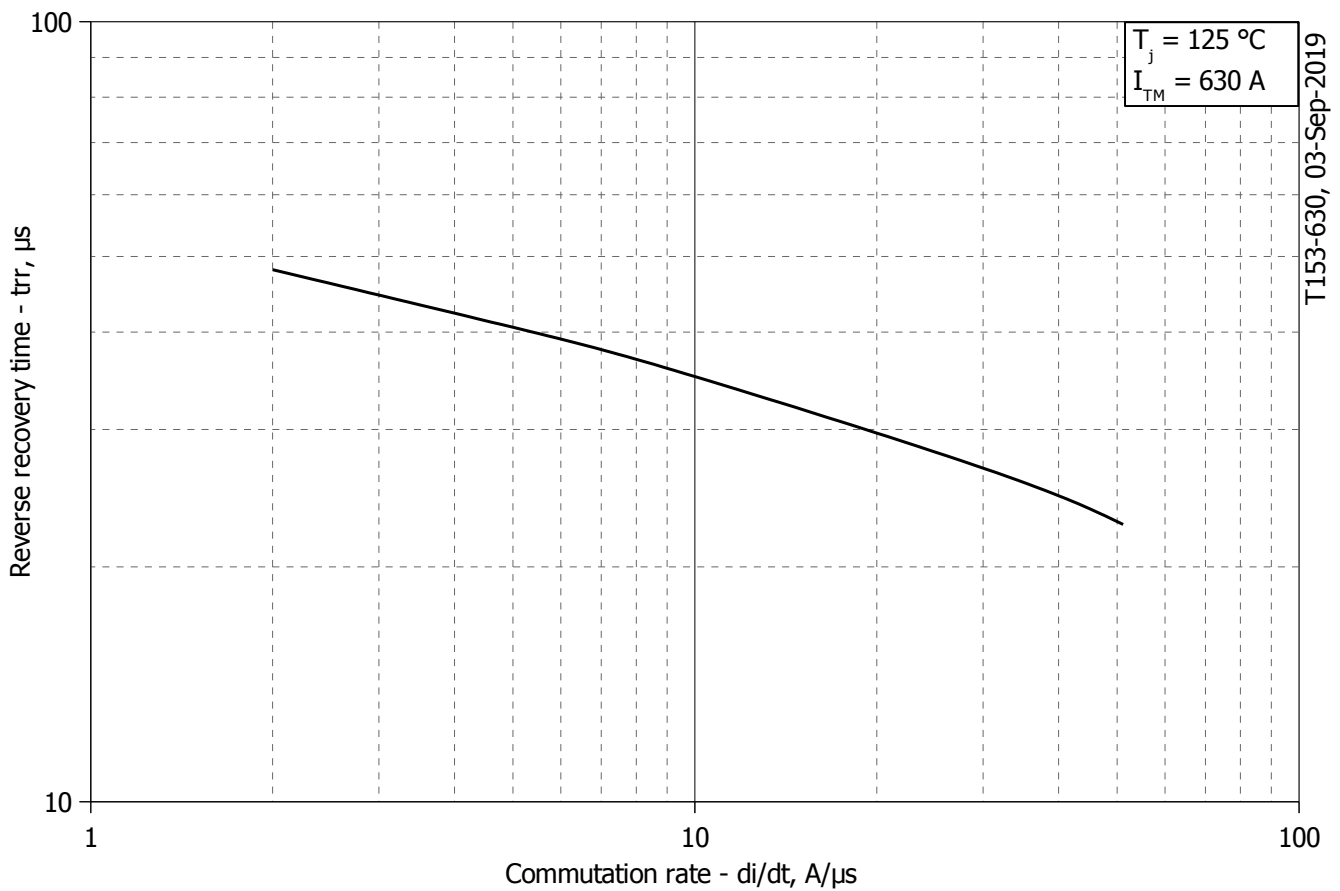
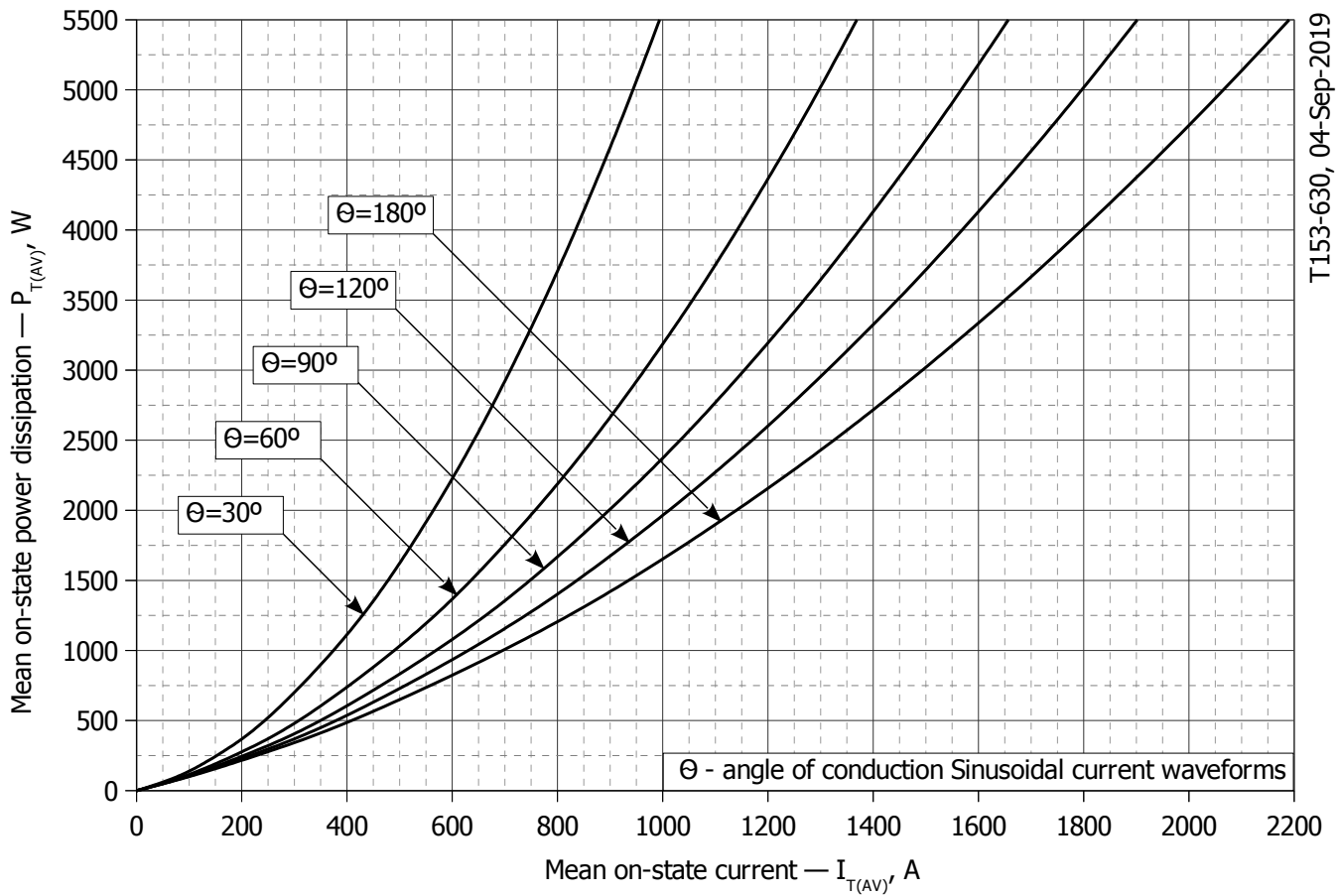
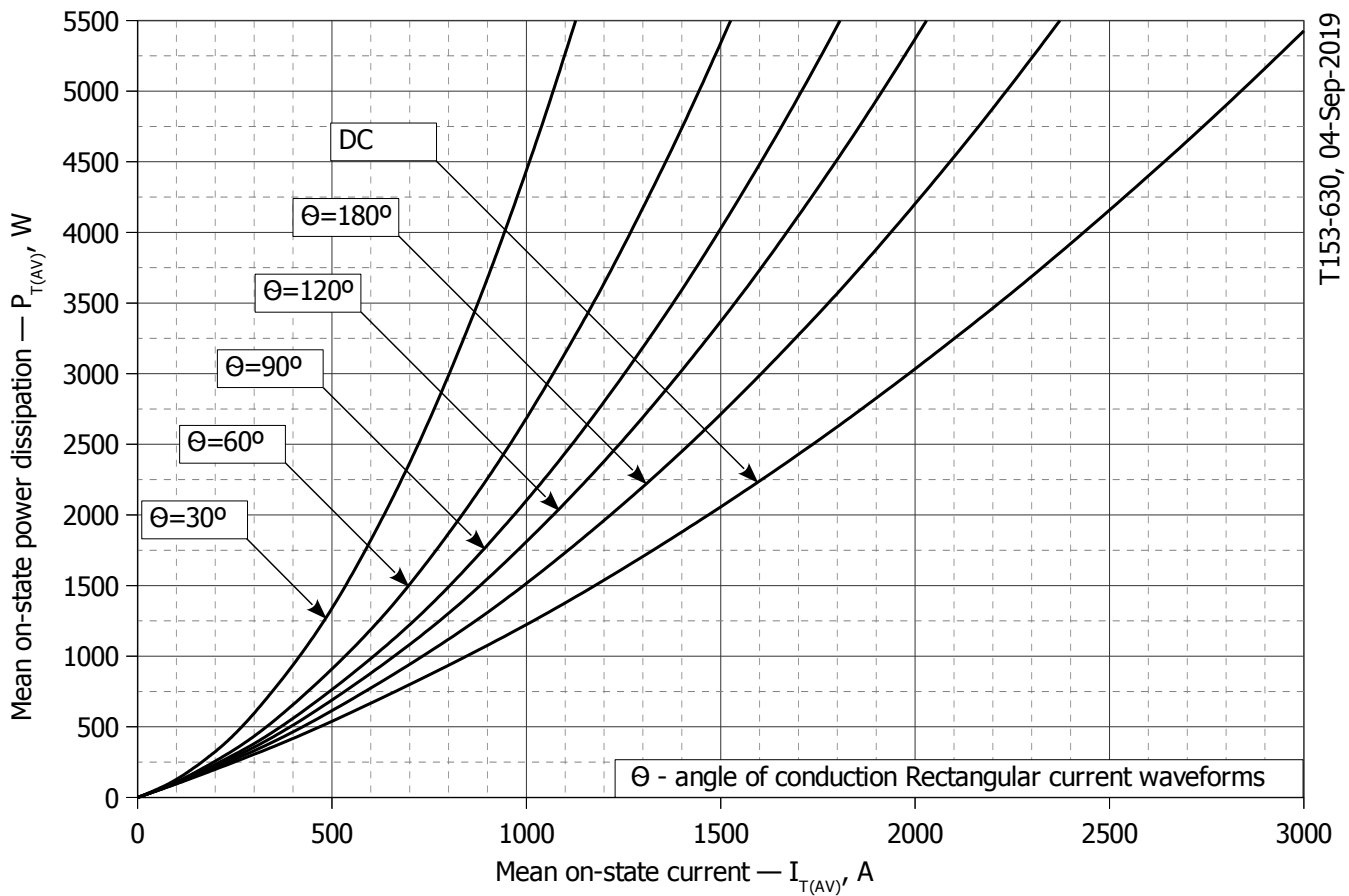

Fig 6 – Maximum recovery time t_{rr} vs. commutation rate di_R/dt (25% chord)



T153-630, 04-Sep-2019

Fig. 7 - Mean on-state power dissipation P_{TAV} vs. mean on-state current I_{TAV} for sinusoidal current waveforms at different conduction angles ($f=50\text{Hz}$, DSC)



T153-630, 04-Sep-2019

Fig. 8 - Mean on-state power dissipation P_{TAV} vs. mean on-state current I_{TAV} for rectangular current waveforms at different conduction angles and for DC ($f=50\text{Hz}$, DSC)

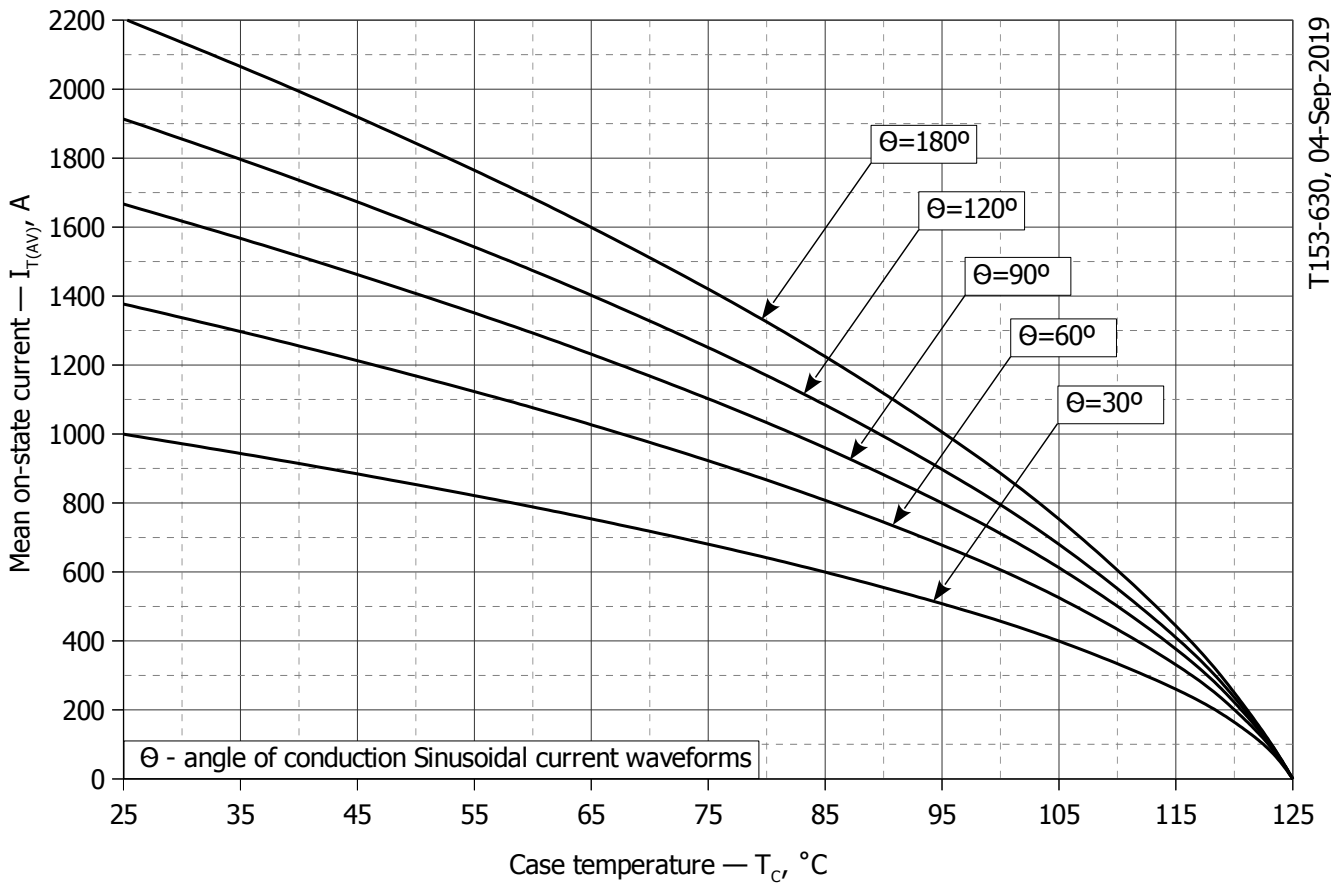

Fig. 9 – Mean on-state current I_{TAV} vs. case temperature T_c for sinusoidal current waveforms at different conduction angles ($f=50\text{Hz}$, DSC)

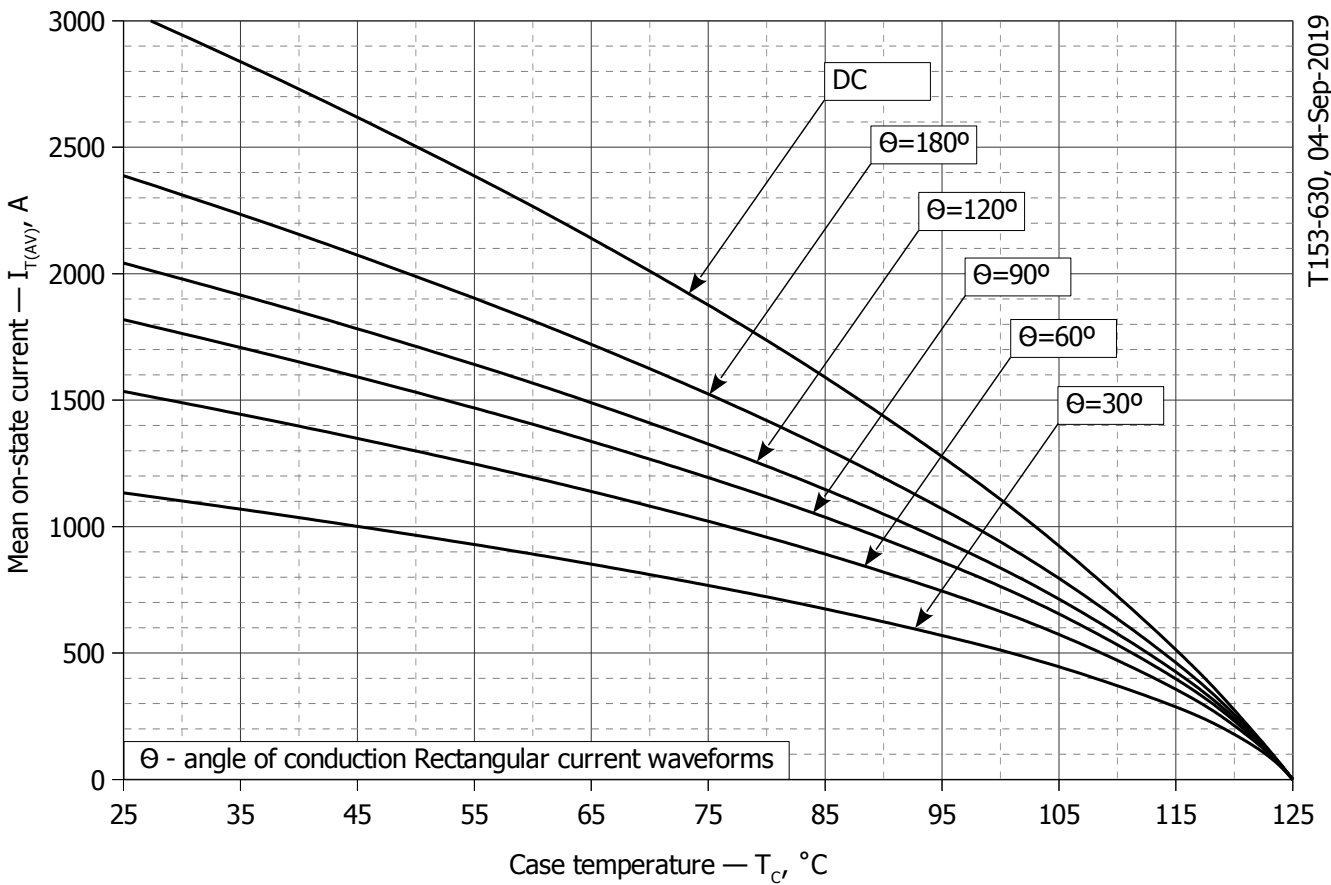

Fig. 10 - Mean on-state current I_{TAV} vs. case temperature T_c for rectangular current waveforms at different conduction angles and for DC ($f=50\text{Hz}$, DSC)

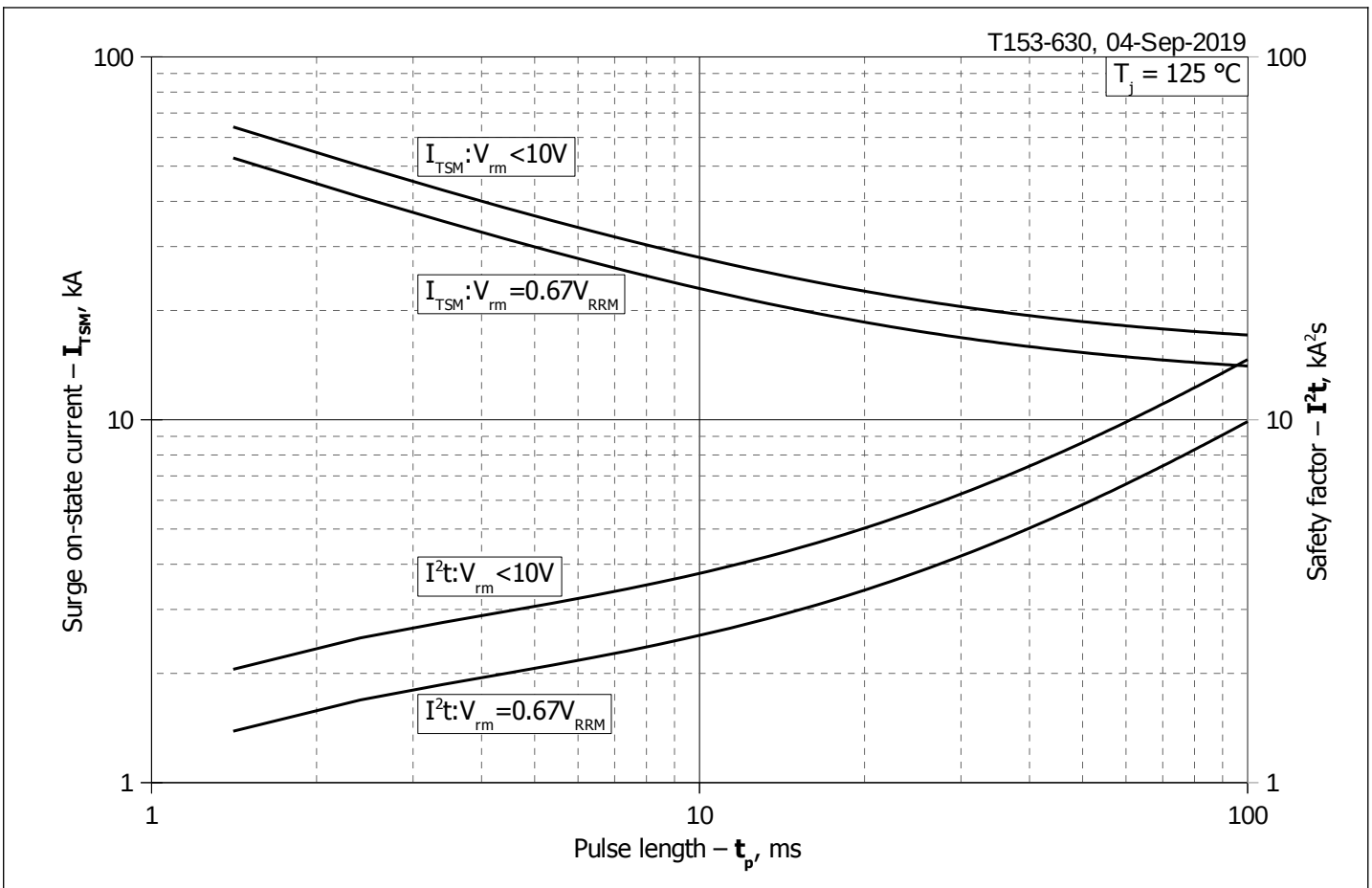

Fig. 11 – Maximum surge on-state current I_{TSM} and safety factor I^2t vs. pulse length t_p

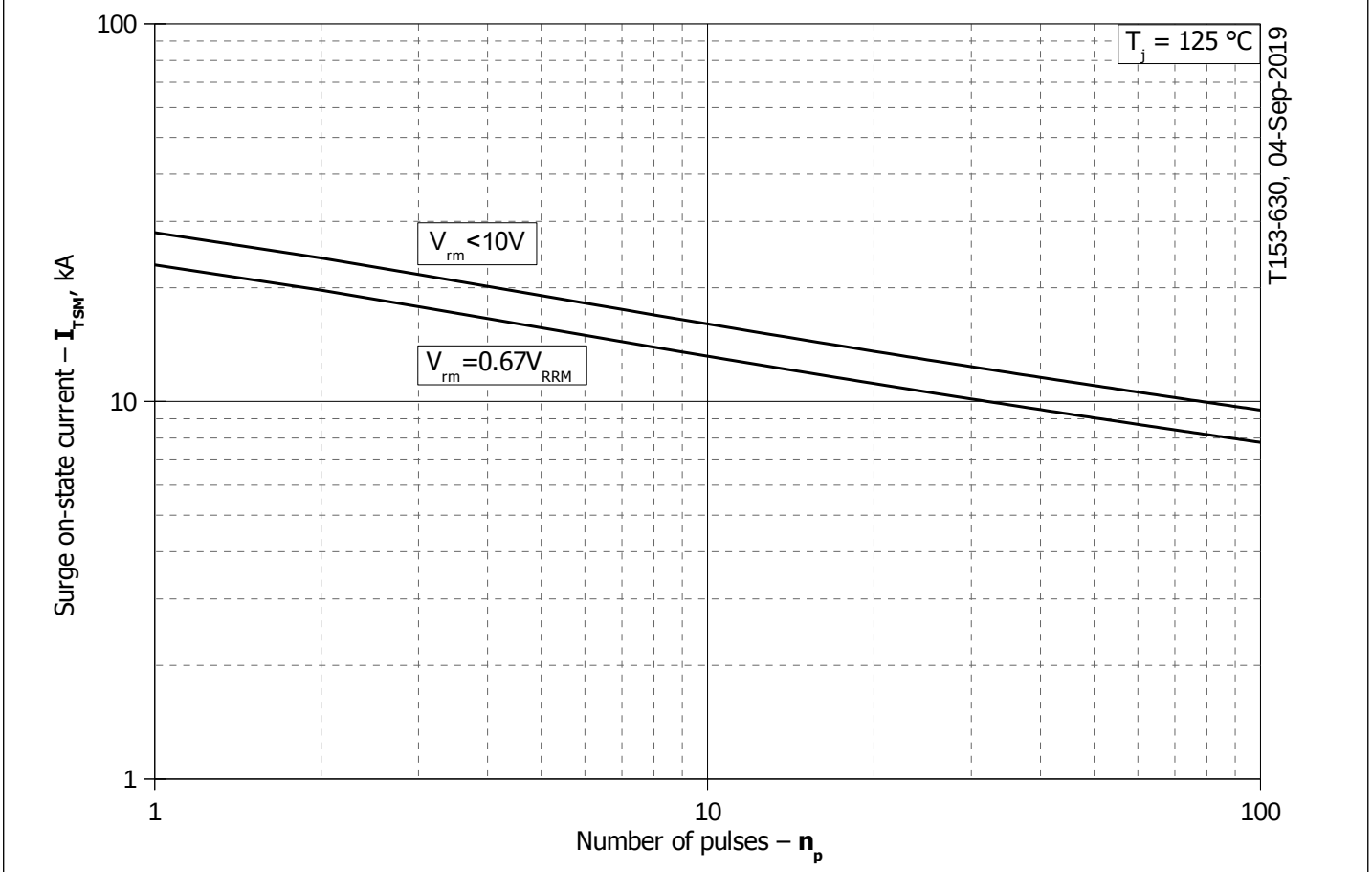

Fig. 12 - Maximum surge on-state current I_{TSM} vs. number of pulses n_p