



High power cycling capability  
Low on-state and switching losses  
Designed for traction and industrial applications

## Phase Control Thyristor Type T123-200-16

Mean on-state current							$I_{TAV}$		200 A					
Repetitive peak off-state voltage							$V_{DRM}$		400 ÷ 1600 V					
Repetitive peak reverse voltage							$V_{RRM}$							
Turn-off time							$t_q$		125, 160, 200, 250, 320, 400, 500 $\mu$ s					
$V_{DRM}, V_{RRM}, V$	400	500	600	700	800	900	1000	1100	1200	1300	1400	1500	1600	
Voltage code	4	5	6	7	8	9	10	11	12	13	14	15	16	
$T_j, ^\circ C$	-60 ÷ 125													

### MAXIMUM ALLOWABLE RATINGS

Symbols and parameters		Units	Values	Test conditions
<b>ON-STATE</b>				
$I_{TAV}$	Mean on-state current	A	200 322	$T_c=104^\circ C$ , Double side cooled $T_c=85^\circ C$ , Double side cooled 180° half-sine wave; 50 Hz
$I_{TRMS}$	RMS on-state current	A	314	$T_c=104^\circ C$ , Double side cooled 180° half-sine wave; 50 Hz
$I_{TSM}$	Surge on-state current	kA	4.0 4.5	$T_j=T_{j\ max}$ $T_j=25^\circ C$ 180° half-sine wave; $t_p=10\ ms$ ; single pulse; $V_D=V_R=0\ V$ ; Gate pulse: $I_G=2\ A$ ; $t_{GP}=50\ \mu s$ ; $di_G/dt \geq 1\ A/\mu s$
			4.0 4.5	$T_j=T_{j\ max}$ $T_j=25^\circ C$ 180° half-sine wave; $t_p=8.3\ ms$ ; single pulse; $V_D=V_R=0\ V$ ; Gate pulse: $I_G=2\ A$ ; $t_{GP}=50\ \mu s$ ; $di_G/dt \geq 1\ A/\mu s$
$I^2t$	Safety factor	$A^2s \cdot 10^3$	80 100	$T_j=T_{j\ max}$ $T_j=25^\circ C$ 180° half-sine wave; $t_p=10\ ms$ ; single pulse; $V_D=V_R=0\ V$ ; Gate pulse: $I_G=2\ A$ ; $t_{GP}=50\ \mu s$ ; $di_G/dt \geq 1\ A/\mu s$
			60 80	$T_j=T_{j\ max}$ $T_j=25^\circ C$ 180° half-sine wave; $t_p=8.3\ ms$ ; single pulse; $V_D=V_R=0\ V$ ; Gate pulse: $I_G=2\ A$ ; $t_{GP}=50\ \mu s$ ; $di_G/dt \geq 1\ A/\mu s$
<b>BLOCKING</b>				
$V_{DRM}, V_{RRM}$	Repetitive peak off-state and Repetitive peak reverse voltages	V	400 ÷ 1600	$T_{j\ min} < T_j < T_{j\ max}$ ; 180° half-sine wave; 50 Hz; Gate open
$V_{DSM}, V_{RSM}$	Non-repetitive peak off-state and Non-repetitive peak reverse voltages	V	500 ÷ 1700	$T_{j\ min} < T_j < T_{j\ max}$ ; 180° half-sine wave; single pulse; Gate open
$V_D, V_R$	Direct off-state and Direct reverse voltages	V	0.6 $V_{DRM}$ 0.6 $V_{RRM}$	$T_j=T_{j\ max}$ ; Gate open

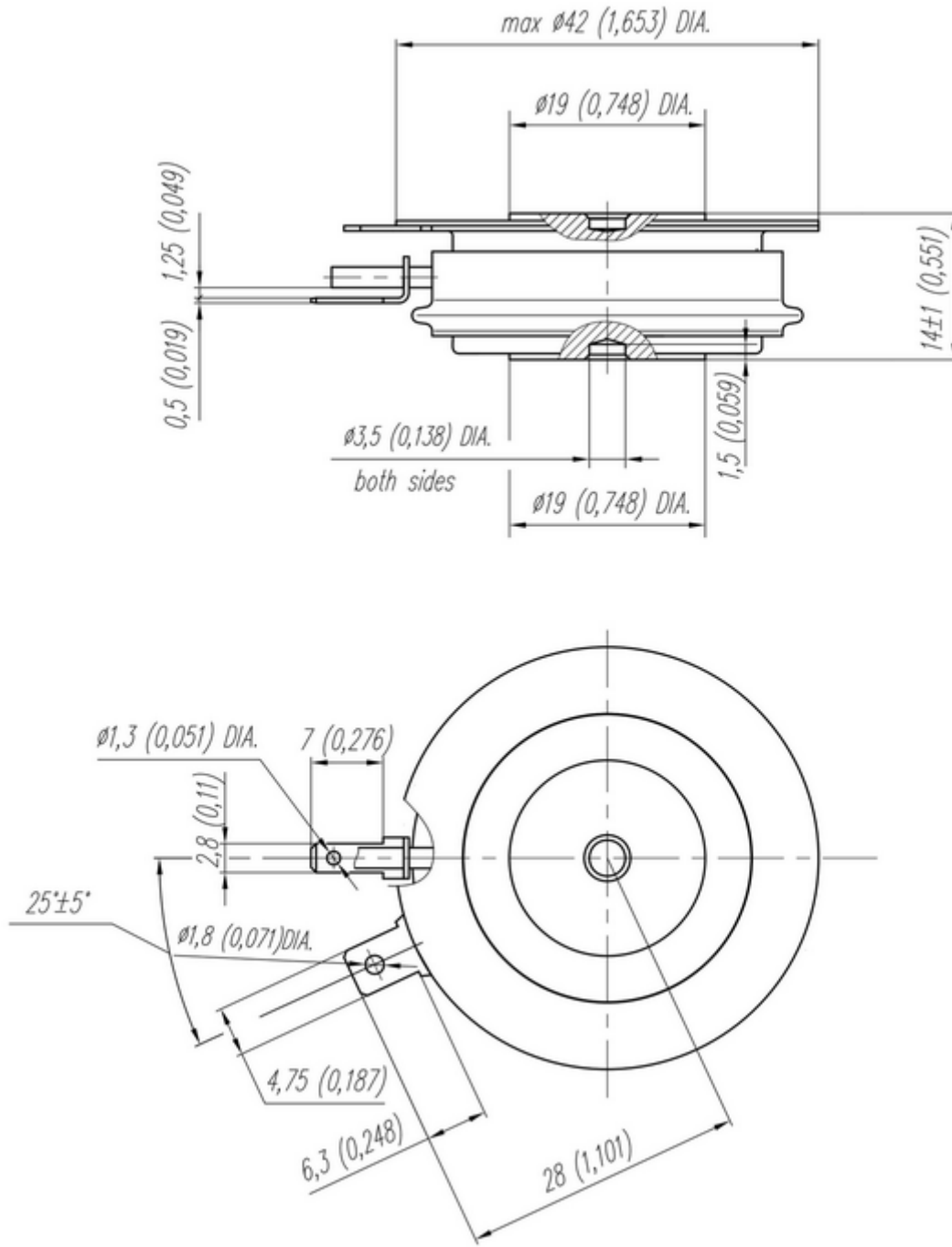
<b>TRIGGERING</b>				
$I_{FGM}$	Peak forward gate current	A	5	$T_j = T_{j\ max}$
$V_{RGM}$	Peak reverse gate voltage	V	5	
$P_G$	Gate power dissipation	W	3	$T_j = T_{j\ max}$ for DC gate current
<b>SWITCHING</b>				
$(di_T/dt)_{crit}$	Critical rate of rise of on-state current non-repetitive (f=1 Hz)	A/ $\mu$ s	800	$T_j = T_{j\ max}$ ; $V_D = 0.67 \cdot V_{DRM}$ ; $I_{TM} = 640$ A; Gate pulse: $I_G = 2$ A; $t_{GP} = 50$ $\mu$ s; $di_G/dt \geq 2$ A/ $\mu$ s
<b>THERMAL</b>				
$T_{stg}$	Storage temperature	$^{\circ}$ C	-60÷50	
$T_j$	Operating junction temperature	$^{\circ}$ C	-60÷125	
<b>MECHANICAL</b>				
F	Mounting force	kN	5.0÷7.0	
a	Acceleration	m/s <sup>2</sup>	50	Device clamped

## CHARACTERISTICS

Symbols and parameters		Units	Values	Conditions	
<b>ON-STATE</b>					
$V_{TM}$	Peak on-state voltage, max	V	1.60	$T_j = 25$ $^{\circ}$ C; $I_{TM} = 628$ A	
$V_{T(TO)}$	On-state threshold voltage, max	V	1.034	$T_j = T_{j\ max}$ ;	
$r_T$	On-state slope resistance, max	m $\Omega$	0.937	$0.5 \pi I_{TAV} < I_T < 1.5 \pi I_{TAV}$	
$I_L$	Latching current, max	mA	500	$T_j = 25$ $^{\circ}$ C; $V_D = 12$ V; Gate pulse: $I_G = 2$ A; $t_{GP} = 50$ $\mu$ s; $di_G/dt \geq 1$ A/ $\mu$ s	
$I_H$	Holding current, max	mA	250	$T_j = 25$ $^{\circ}$ C; $V_D = 12$ V; Gate open	
<b>BLOCKING</b>					
$I_{DRM}, I_{RRM}$	Repetitive peak off-state and Repetitive peak reverse currents, max	mA	50	$T_j = T_{j\ max}$ ; $V_D = V_{DRM}$ ; $V_R = V_{RRM}$	
$(dv_D/dt)_{crit}$	Critical rate of rise of off-state voltage <sup>1)</sup> , min	V/ $\mu$ s	200, 320, 500, 1000, 1600, 2000, 2500	$T_j = T_{j\ max}$ ; $V_D = 0.67 \cdot V_{DRM}$ ; Gate open	
<b>TRIGGERING</b>					
$V_{GT}$	Gate trigger direct voltage, max	V	3.00 2.50 1.50	$T_j = T_{j\ min}$ $T_j = 25$ $^{\circ}$ C $T_j = T_{j\ max}$	$V_D = 12$ V; $I_D = 3$ A; Direct gate current
$I_{GT}$	Gate trigger direct current, max	mA	400 250 150	$T_j = T_{j\ min}$ $T_j = 25$ $^{\circ}$ C $T_j = T_{j\ max}$	
$V_{GD}$	Gate non-trigger direct voltage, min	V	0.70	$T_j = T_{j\ max}$ ;	
$I_{GD}$	Gate non-trigger direct current, min	mA	65.00	$V_D = 0.67 \cdot V_{DRM}$ ; Direct gate current	
<b>SWITCHING</b>					
$t_{gd}$	Delay time, max	$\mu$ s	1.10	$T_j = 25$ $^{\circ}$ C; $V_D = 1000$ V; $I_{TM} = I_{TAV}$ ; $di/dt = 200$ A/ $\mu$ s;	
$t_{gt}$	Turn-on time, max	$\mu$ s	3.00	Gate pulse: $I_G = 2$ A; $V_G = 20$ V; $t_{GP} = 50$ $\mu$ s; $di_G/dt = 2$ A/ $\mu$ s	
$t_q$	Turn-off time <sup>2)</sup> , max	$\mu$ s	125, 160, 200, 250, 320, 400, 500	$dv_D/dt = 50$ V/ $\mu$ s; $T_j = T_{j\ max}$ ; $I_{TM} = I_{TAV}$ ; $di_R/dt = -10$ A/ $\mu$ s; $V_R = 100$ V; $V_D = 0.67 \cdot V_{DRM}$	
$Q_{rr}$	Total recovered charge, max	$\mu$ C	700	$T_j = T_{j\ max}$ ; $I_{TM} = 200$ A;	
$t_{rr}$	Reverse recovery time, max	$\mu$ s	16	$di_R/dt = -10$ A/ $\mu$ s;	
$I_{rrM}$	Peak reverse recovery current, max	A	88	$V_R = 100$ V	

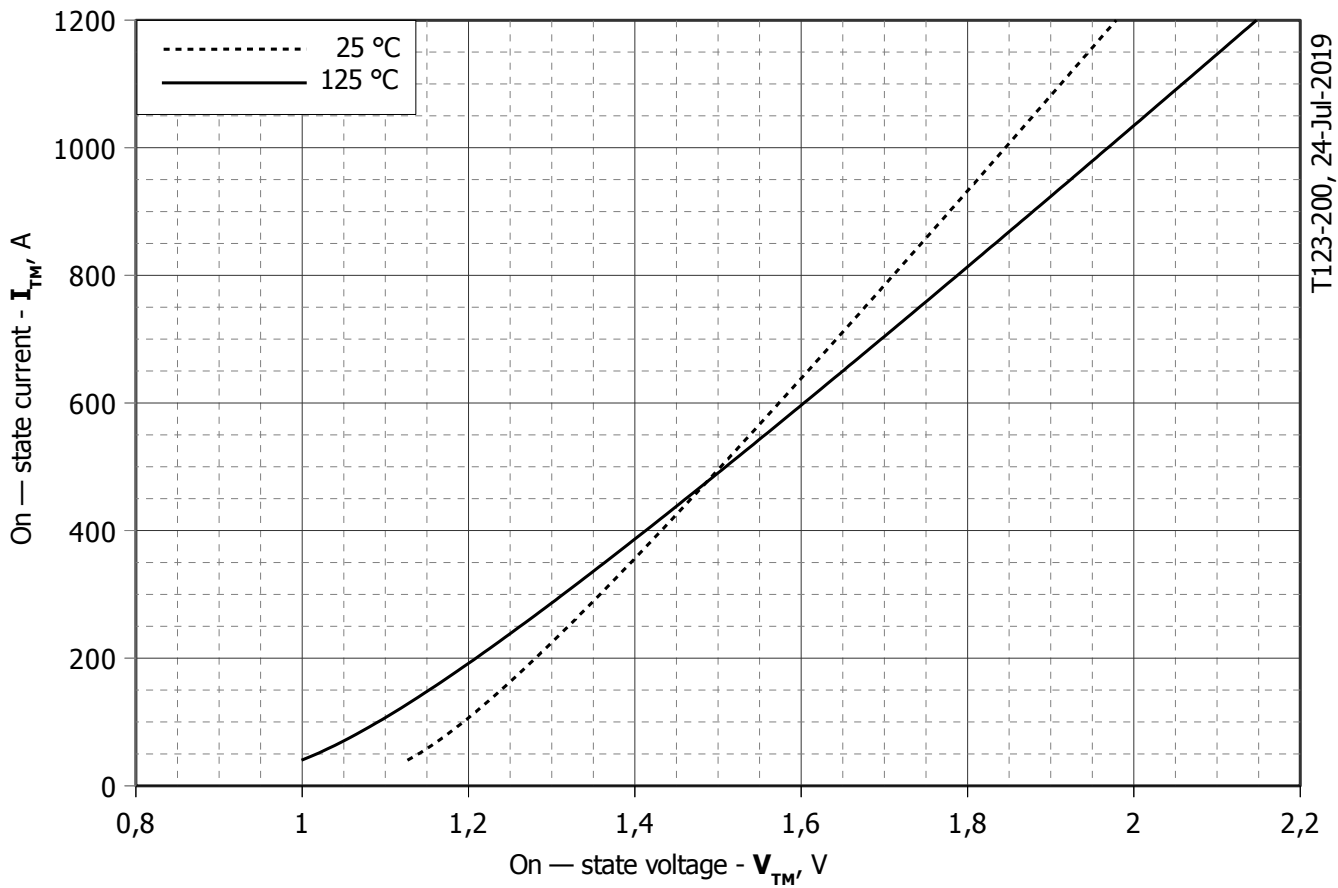
THERMAL					
$R_{thjc}$	Thermal resistance, junction to case, max	°C/W	0.070	Direct current	Double side cooled
$R_{thjc-A}$			0.154		Anode side cooled
$R_{thjc-K}$			0.126		Cathode side cooled
$R_{thck}$	Thermal resistance, case to heatsink, max	°C/W	0.010	Direct current	
MECHANICAL					
w	Weight, max	g	70		
$D_s$	Surface creepage distance	mm (inch)	7.94 (0.313)		
$D_a$	Air strike distance	mm (inch)	5.00 (0.197)		

PART NUMBERING GUIDE							NOTES																																						
T	123	200	16	A2	E2	N																																							
1	2	3	4	5	6	7																																							
1. Phase Control Thyristor 2. Design version 3. Mean on-state current, A 4. Voltage code 5. Critical rate of rise of off-state voltage, V/μs 6. Turn-off time ( $dv_o/dt=50$ V/μs) 7. Ambient conditions: N – normal; T – tropical							1) Critical rate of rise of off-state voltage <table border="1"> <thead> <tr> <th>Symbol of Group</th> <th>P2</th> <th>K2</th> <th>E2</th> <th>A2</th> <th>T1</th> <th>P1</th> <th>M1</th> </tr> </thead> <tbody> <tr> <td><math>(dv_o/dt)_{crit}</math>, V/μs</td> <td>200</td> <td>320</td> <td>500</td> <td>1000</td> <td>1600</td> <td>2000</td> <td>2500</td> </tr> </tbody> </table> 2) Turn-off time ( $dv_o/dt=50$ V/μs) <table border="1"> <thead> <tr> <th>Symbol of Group</th> <th>X2</th> <th>T2</th> <th>P2</th> <th>M2</th> <th>K2</th> <th>H2</th> <th>E2</th> </tr> </thead> <tbody> <tr> <td><math>t_q</math>, μs</td> <td>125</td> <td>160</td> <td>200</td> <td>250</td> <td>320</td> <td>400</td> <td>500</td> </tr> </tbody> </table>							Symbol of Group	P2	K2	E2	A2	T1	P1	M1	$(dv_o/dt)_{crit}$ , V/μs	200	320	500	1000	1600	2000	2500	Symbol of Group	X2	T2	P2	M2	K2	H2	E2	$t_q$ , μs	125	160	200	250	320	400	500
Symbol of Group	P2	K2	E2	A2	T1	P1	M1																																						
$(dv_o/dt)_{crit}$ , V/μs	200	320	500	1000	1600	2000	2500																																						
Symbol of Group	X2	T2	P2	M2	K2	H2	E2																																						
$t_q$ , μs	125	160	200	250	320	400	500																																						



All dimensions in millimeters (inches)

The information contained herein is confidential and protected by Copyright. In the interest of product improvement, Proton-Electrotex reserves the right to change data sheet without notice.



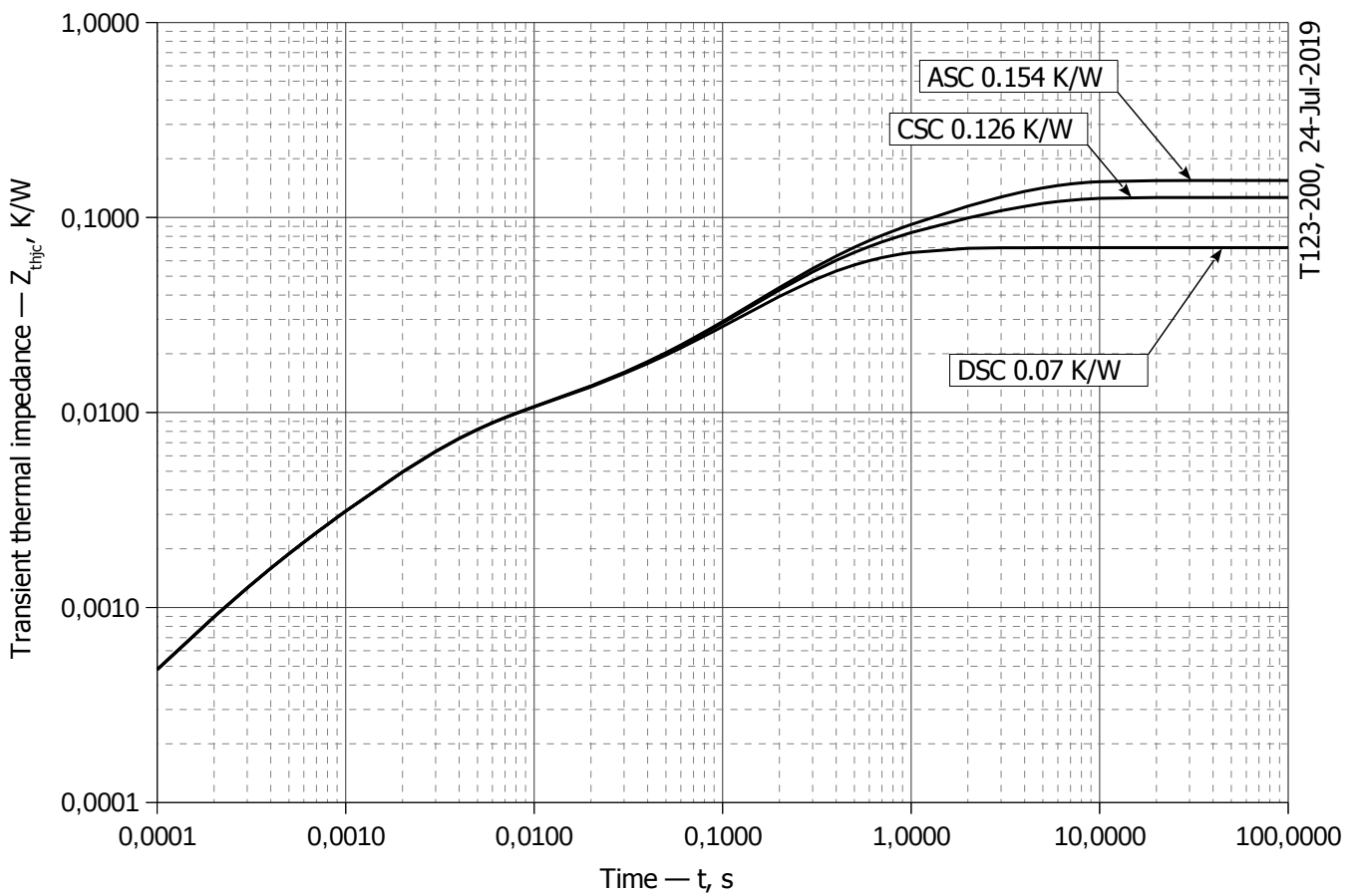
**Fig 1 – On-state characteristics of Limit device**

Analytical function for On-state characteristic:

$$V_T = A + B \cdot i_T + C \cdot \ln(i_T + 1) + D \cdot \sqrt{i_T}$$

	Coefficients for max curves	
	$T_j = 25^\circ\text{C}$	$T_j = T_{j\text{max}}$
<b>A</b>	0.9910900	0.8108200
<b>B</b>	0.0006196	0.0008273
<b>C</b>	0.0273400	0.0382730
<b>D</b>	0.0014502	0.0020951

**On-state characteristic model (see Fig. 1)**



T123-200, 24-Jul-2019

**Fig 2 – Transient thermal impedance  $Z_{thjc}$  vs. time  $t$**

Analytical function for Transient thermal impedance junction to case  $Z_{thjc}$  for DC:

$$Z_{thjc} = \sum_{i=1}^n R_i \left( 1 - e^{-\frac{t}{\tau_i}} \right)$$

Where  $i = 1$  to  $n$ ,  $n$  is the number of terms in the series.

$t$  = Duration of heating pulse in seconds.

$Z_{thjc}$  = Thermal resistance at time  $t$ .

$R_i$  = Amplitude of  $p_{th}$  term.

$\tau_i$  = Time constant of  $r_{th}$  term.

DC Double side cooled

$i$	1	2	3	4	5	6
$R_i$ , K/W	0.03233	0.02226	0.005231	0.002739	0.006738	0.0006988
$\tau_i$ , s	0.2392	0.533	0.1478	0.01499	0.002749	0.0002969

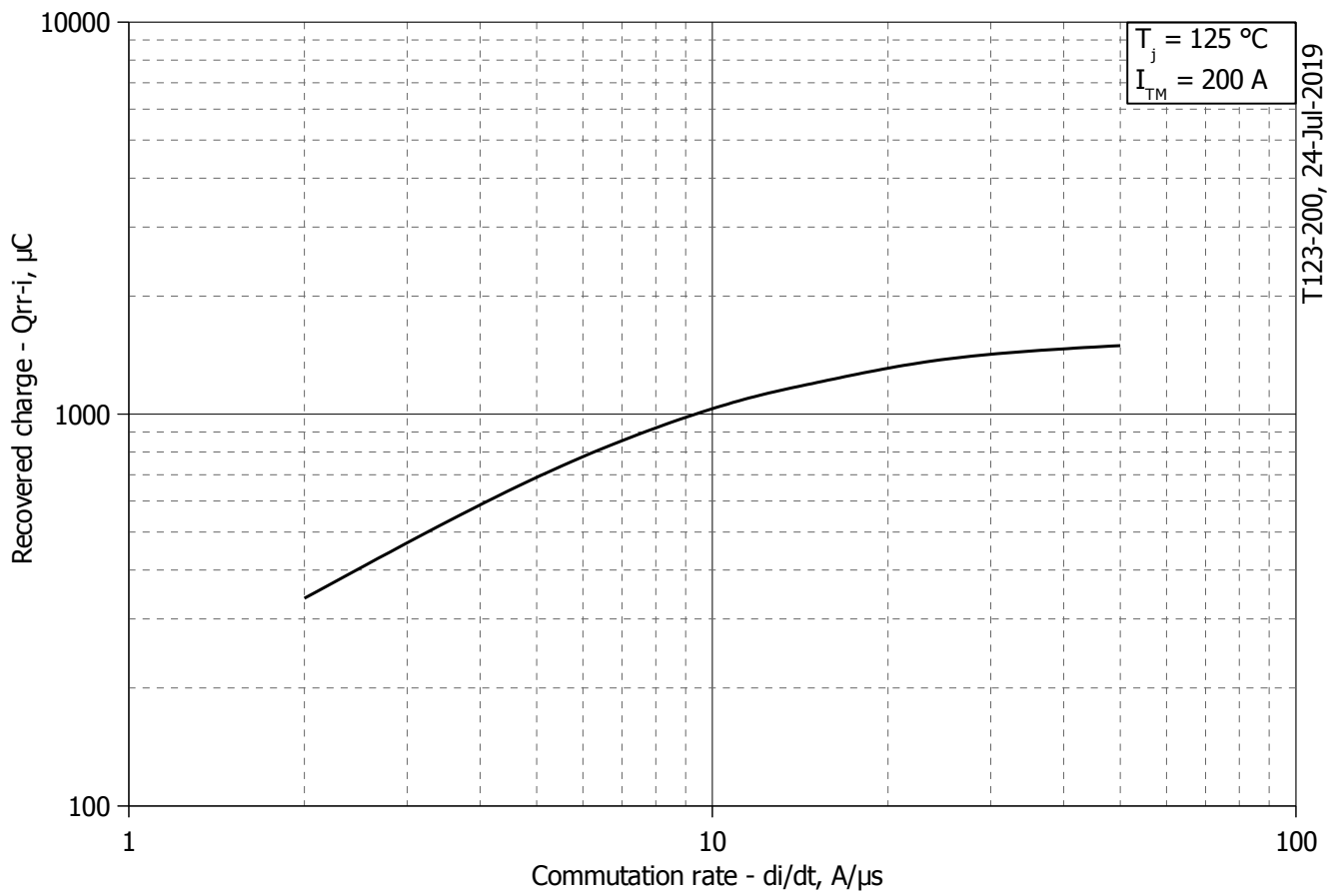
DC Anode side cooled

$i$	1	2	3	4	5	6
$R_i$ , K/W	0.08459	0.02327	0.002598	0.006598	0.0006736	0.03694
$\tau_i$ , s	2.653	0.5669	0.01311	0.00269	0.0002871	0.2416

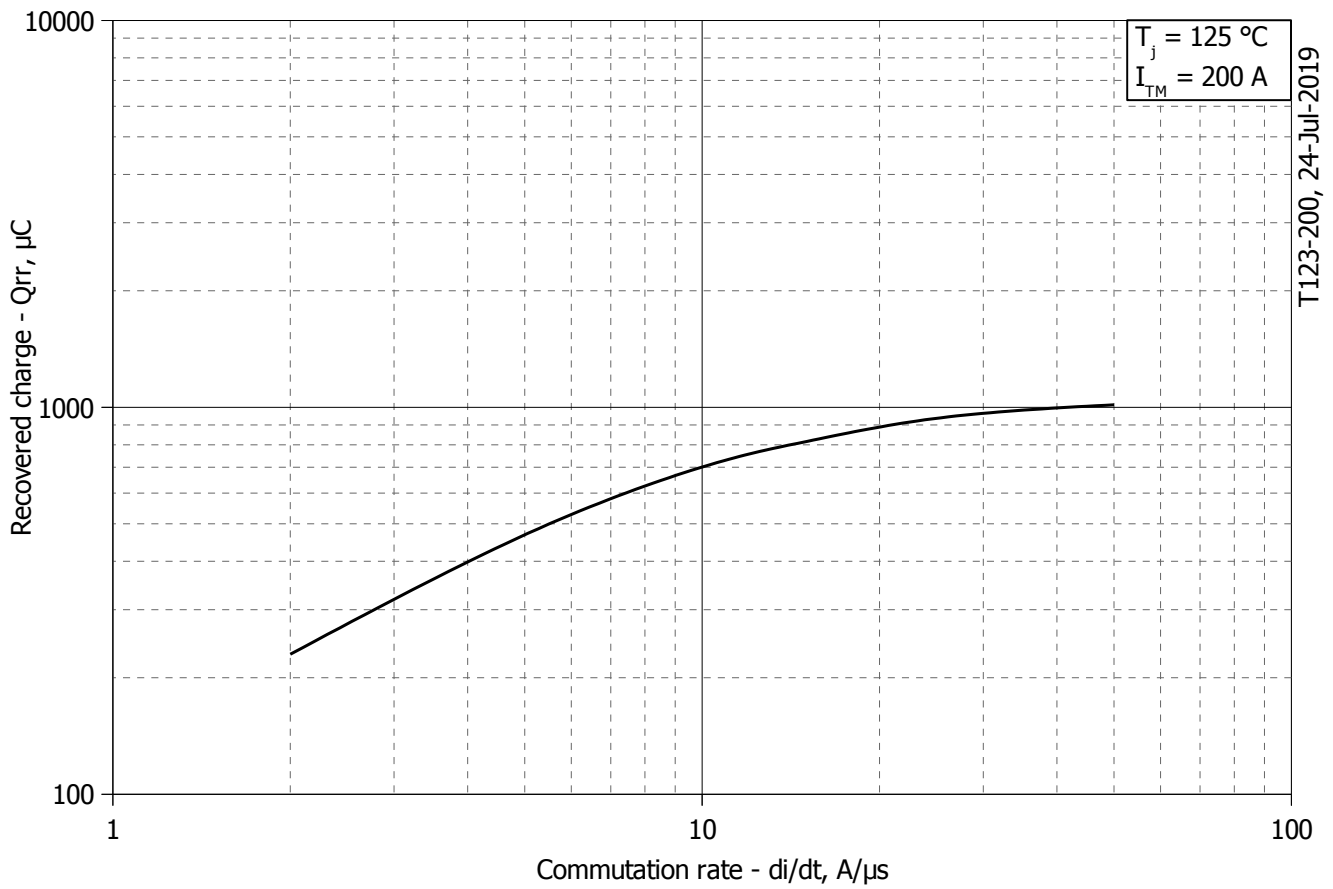
DC Cathode side cooled

$i$	1	2	3	4	5	6
$R_i$ , K/W	0.05654	0.03706	0.002638	0.006637	0.0006786	0.02303
$\tau_i$ , s	2.653	0.2338	0.01361	0.002704	0.000289	0.5476

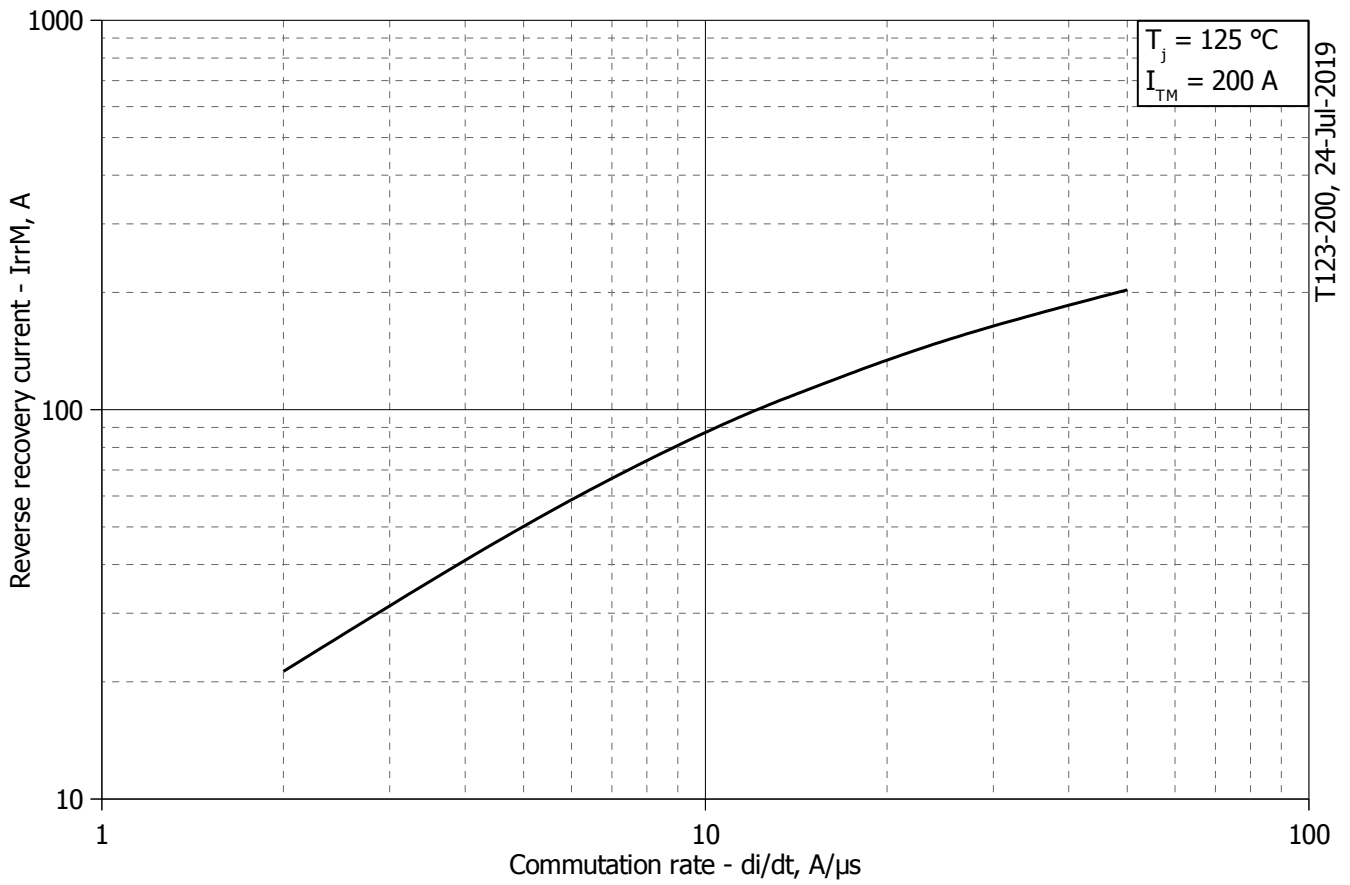
**Transient thermal impedance junction to case  $Z_{thjc}$  model (see Fig. 2)**



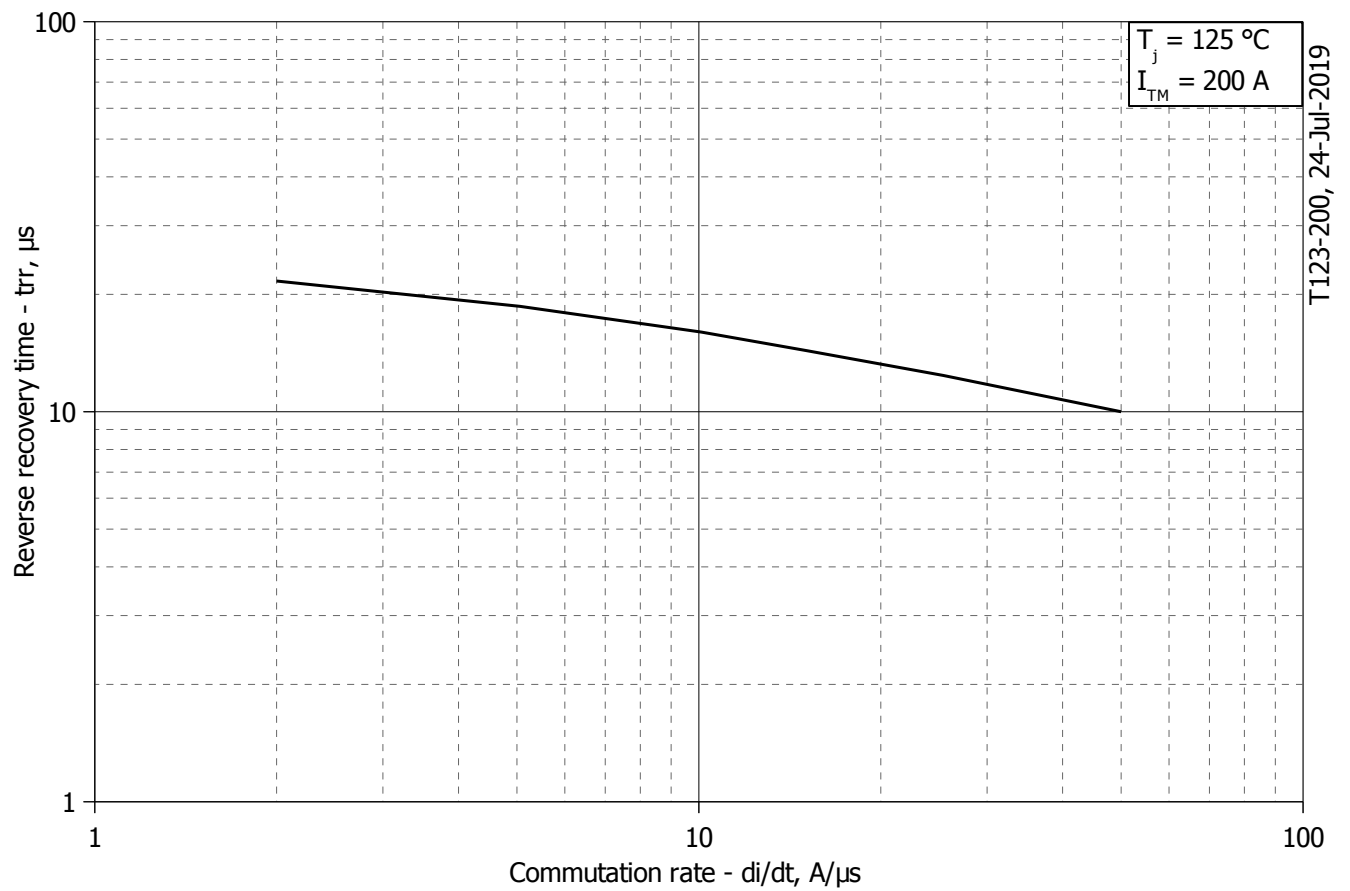
**Fig 3 – Maximum recovered charge  $Q_{rr-i}$  (integral) vs. commutation rate  $di_R/dt$**



**Fig 4 – Maximum recovered charge  $Q_{rr}$  vs. commutation rate  $di_R/dt$  (25% chord)**

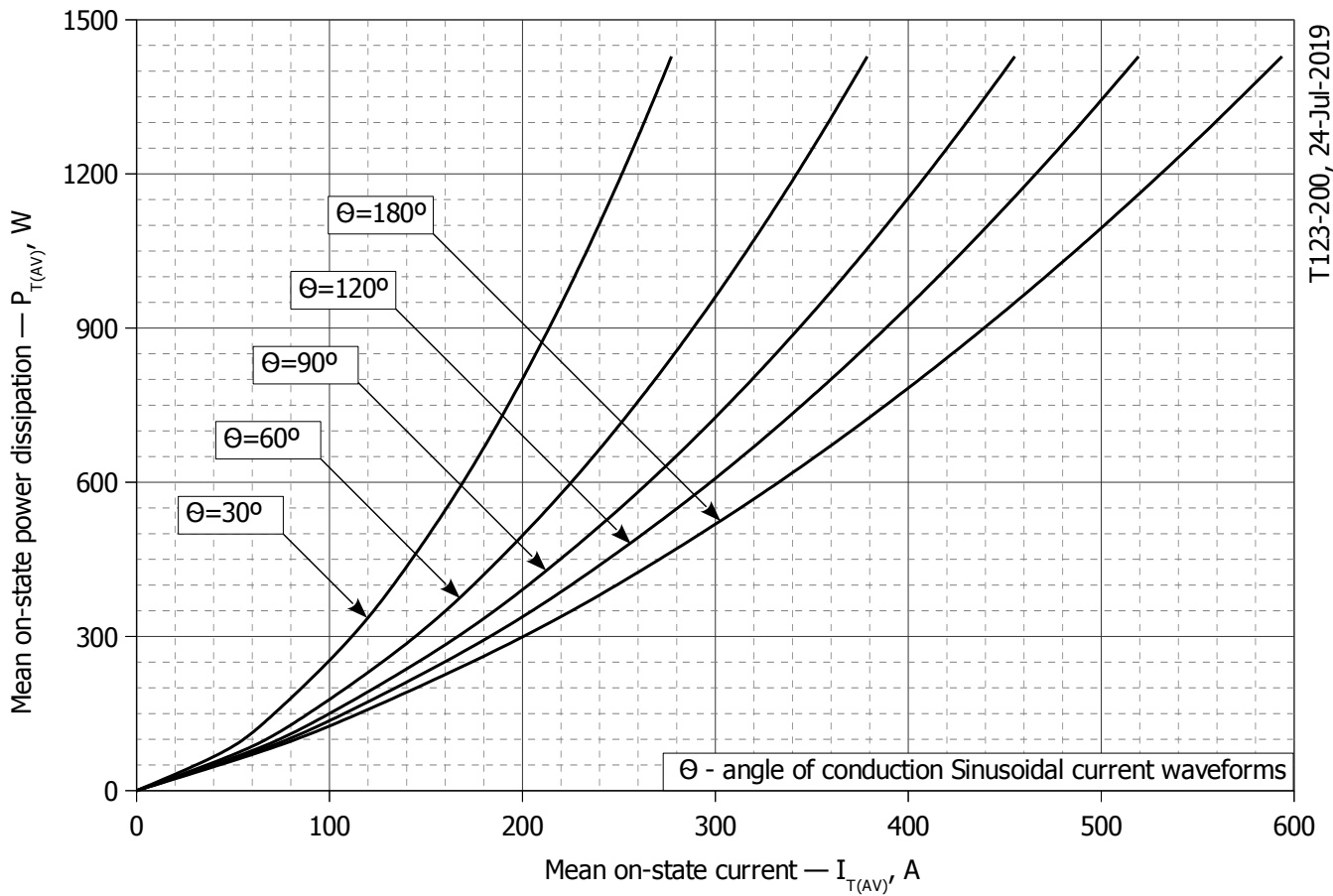


**Fig 5 – Maximum reverse recovery current  $I_{rrM}$  vs. commutation rate  $di_R/dt$**



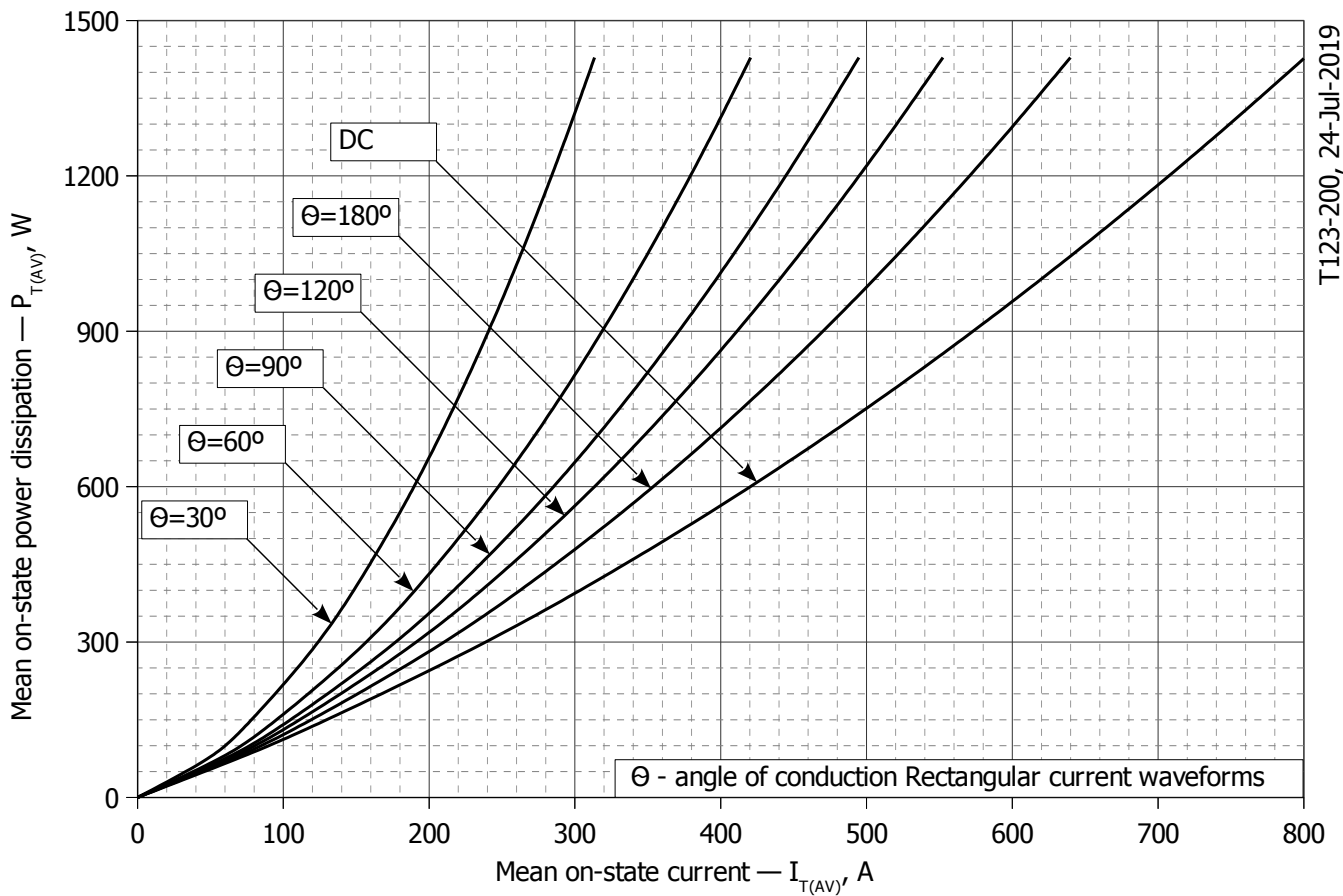
**Fig 6 – Maximum recovery time  $t_{rr}$  vs. commutation rate  $di_R/dt$  (25% chord)**





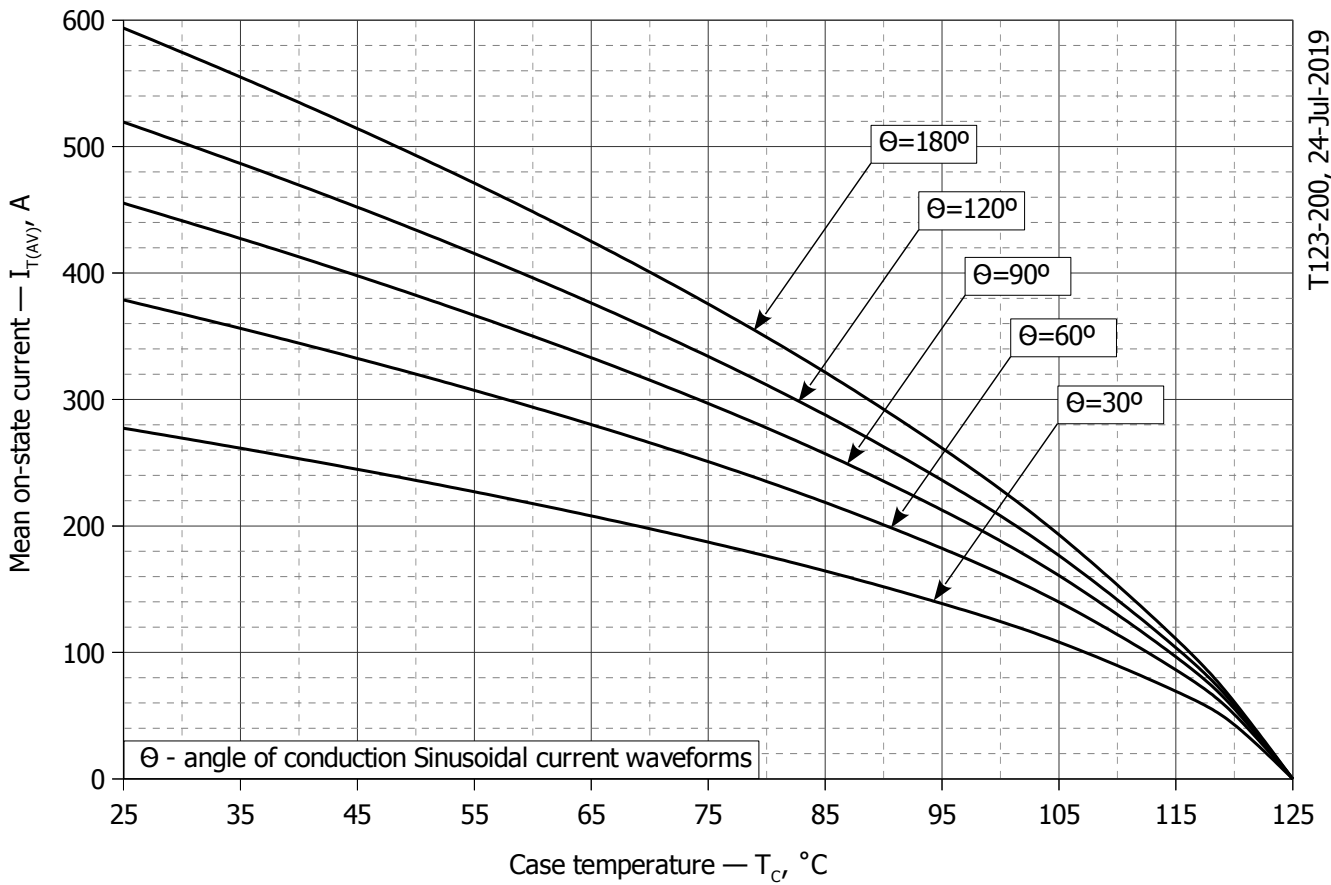
T123-200, 24-Jul-2019

**Fig. 7 - Mean on-state power dissipation  $P_{TAV}$  vs. mean on-state current  $I_{TAV}$  for sinusoidal current waveforms at different conduction angles ( $f=50\text{Hz}$ , DSC)**

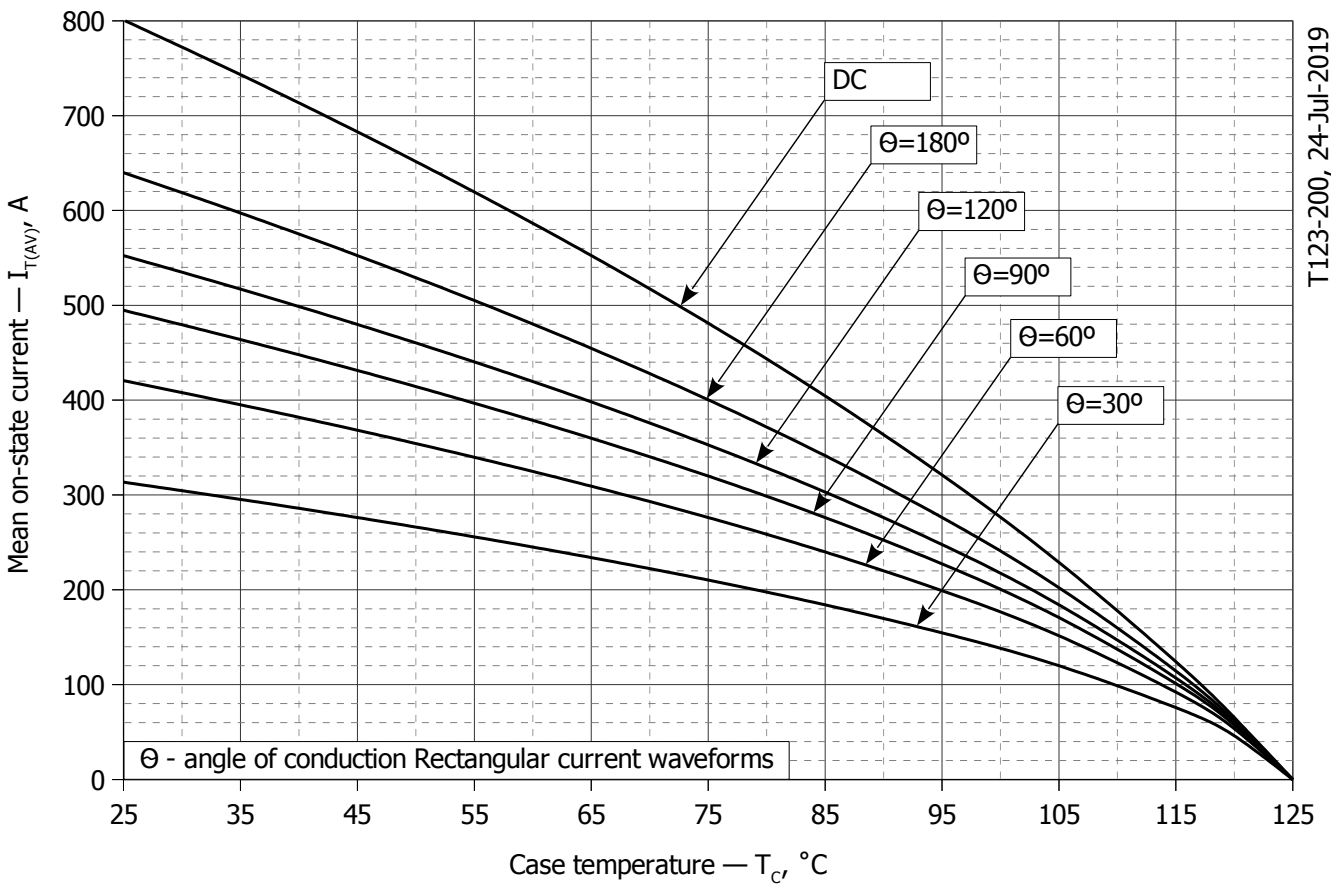


T123-200, 24-Jul-2019

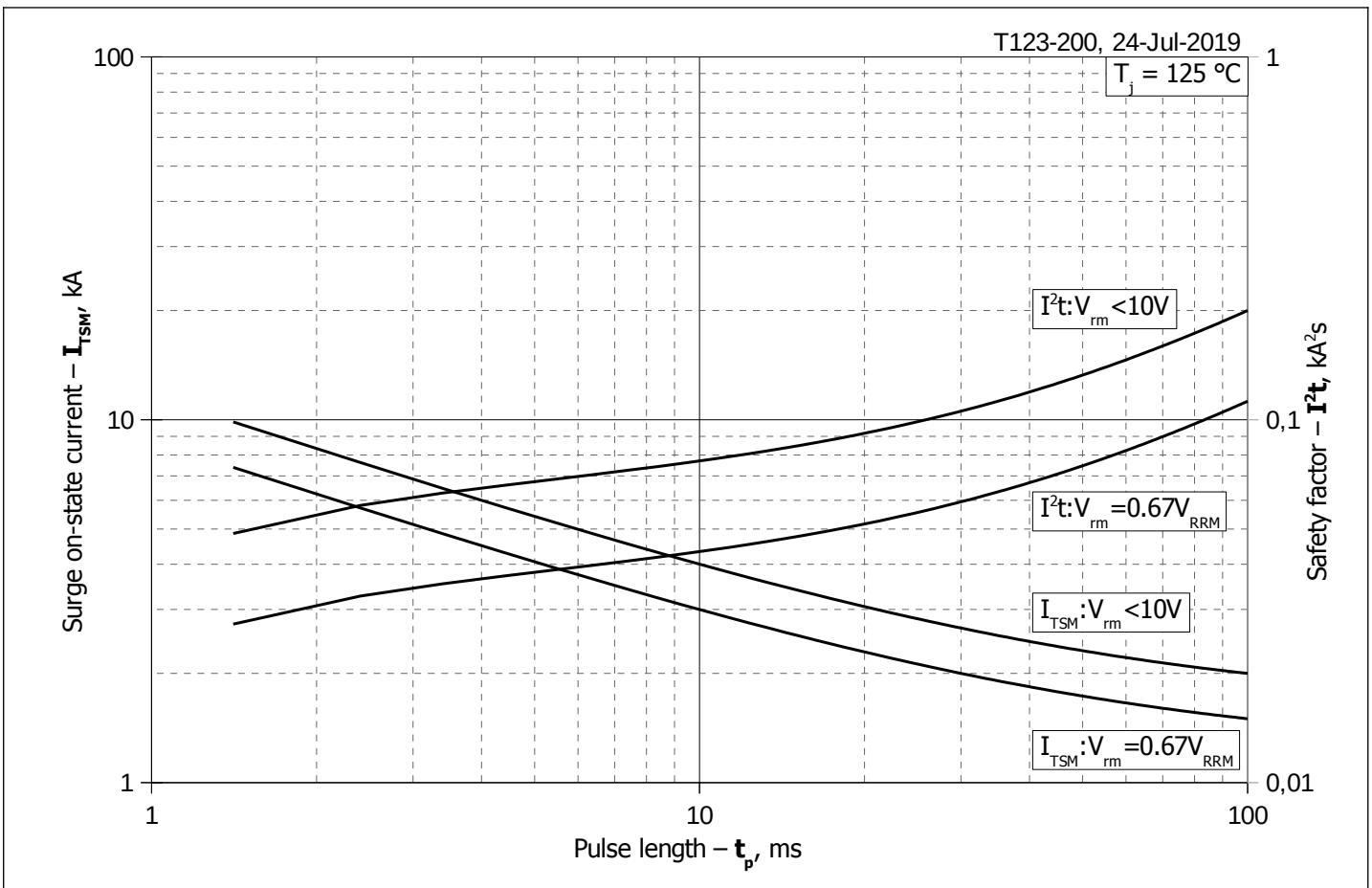
**Fig. 8 - Mean on-state power dissipation  $P_{TAV}$  vs. mean on-state current  $I_{TAV}$  for rectangular current waveforms at different conduction angles and for DC ( $f=50\text{Hz}$ , DSC)**



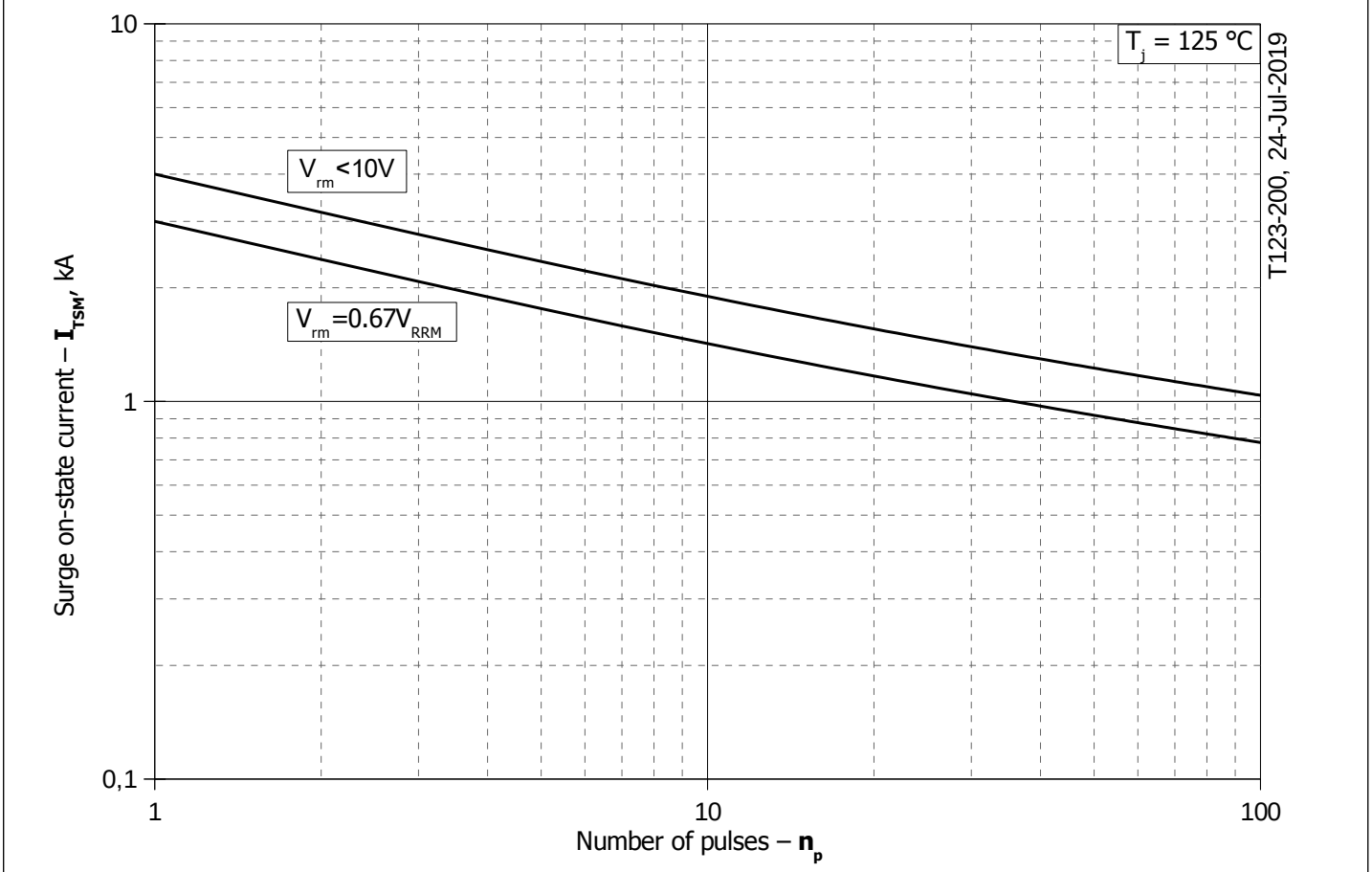
**Fig. 9 – Mean on-state current  $I_{TAV}$  vs. case temperature  $T_c$  for sinusoidal current waveforms at different conduction angles ( $f=50\text{Hz}$ , DSC)**



**Fig. 10 - Mean on-state current  $I_{TAV}$  vs. case temperature  $T_c$  for rectangular current waveforms at different conduction angles and for DC ( $f=50\text{Hz}$ , DSC)**



**Fig. 11 – Maximum surge on-state current  $I_{TSM}$  and safety factor  $I^2t$  vs. pulse length  $t_p$**



**Fig. 12 - Maximum surge on-state current  $I_{TSM}$  vs. number of pulses  $n_p$**