

Low Inductance IGBT Module with 17 mm Height Housing
1700 V 450 A
Chip features

- IGBT chip
 - Trench FS
 - low $V_{CE(sat)}$ value
 - 10 μ s short circuit duration at 150°C
 - square RBSOA of 2xlc
 - low EMI
- FRD chip
 - fast and soft reverse recovery
 - low voltage drop

Design features

- copper baseplate
- Al_2O_3 DBC substrate
- ultrasonic welded power terminals
- improved thermal cycling
- RoHS compliant

Typical application

- AC motor drives
- solar inverters
- air conditioning
- high power converters and UPS
- Inverters for wind energy converters

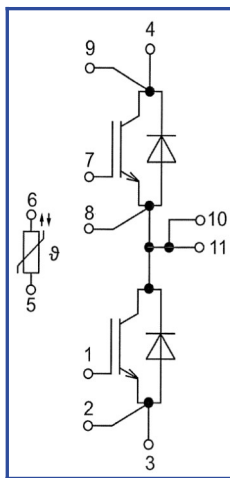
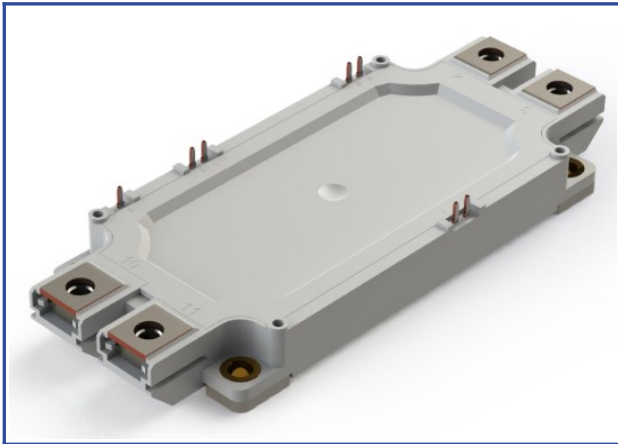
Maximum rated values

Definition	Symbol	Conditions	Value	Unit
IGBT				
Collector-Emitter voltage	V_{CES}	$V_{GE} = 0$.	1700	V
Maximum allowable collector current (continuous)	$I_{C 25}$	$T_{vj (max)} = 175^{\circ}C$; $T_c = 25^{\circ}C$.	655	A
	$I_{C 80}$	$T_{vj (max)} = 175^{\circ}C$; $T_c = 80^{\circ}C$.	450	A
Repetitive peak collector current*1	I_{CRM}	$I_{CRM} = 2 \times I_{C nom}$; $t_p = 1$ ms.	900	A
Short-circuit duration	t_{psc}	$T_{vj} = 25^{\circ}C$; $V_{GE} = \pm 15$ V; $V_{CE} = 700$ V; $R_{G on} = R_{G off} = 3 \Omega$; $I_{C max} < 2590$ A.	10	μ s
		$T_{vj} = 150^{\circ}C$; $V_{GE} = \pm 15$ V; $V_{CE} = 700$ V; $R_{G on} = R_{G off} = 3 \Omega$; $I_{C max} < 2053$ A.	10	
Gate-Emitter voltage	V_{GES}		± 20	V
Junction operating temperature	$T_{vj (op)}$		-40...+150	$^{\circ}C$
Inverse diode				
Repetitive peak reverse voltage	V_{RRM}	$V_{GE} = 0$ V.	1700	V
Maximum allowable forward current (continuous)	$I_{F 25}$	$T_{vj (max)} = 175^{\circ}C$; $T_c = 25^{\circ}C$.	489	A
	$I_{F 80}$	$T_{vj (max)} = 175^{\circ}C$; $T_c = 80^{\circ}C$.	371	A
Repetitive peak forward current*1	I_{FRM}	$I_{FRM} = 2 \times I_{F nom}$; $t_p = 1$ ms.	900	A
Junction operating temperature	$T_{vj (op)}$		-40...+150	$^{\circ}C$
Module				
Storage temperature	T_{stg}		-40...+50	$^{\circ}C$
Isolation voltage	V_{isol}	AC sin 50 Hz; $t = 1$ min.	4000	V

*1 Pulse width and repetition rate should be such that device junction temperature does not exceed maximum T_{vj} rating

Characteristics

Definition	Symbol	Conditions	Value			Unit.		
			min.	typ.	max.			
IGBT								
Collector-Emitter saturation voltage	V_{CEsat}	$V_{GE} = +15\text{ V}; I_C = 450\text{ A}; t_u = 1000\text{ }\mu\text{s}.$	$T_{vj} = 25^\circ\text{C}$ $T_{vj} = 150^\circ\text{C}$	1.85 2.35	2.20 2.80	2.55 3.25	V V	
Gate-Emitter threshold voltage	$V_{GE(th)}$	$I_C = 18\text{ mA}; V_{CE} = V_{GE}; T_{vj} = 25^\circ\text{C}; t_u = 2\text{ ms}.$		4.90	5.50	6.10	V	
Collector-Emitter cut-off current	I_{CES}	$V_{CE} = 1700\text{ V}; t_u = 50\text{ ms}; V_{GE} = 0.$	$T_{vj} = 25^\circ\text{C}$ $T_{vj} = 150^\circ\text{C}$	- -	19 13	100 20	μA mA	
Gate-Emitter leakage current	I_{GES}	$V_{CE} = 0; V_{GE} = \pm 20\text{ V}; T_{vj} = 25^\circ\text{C}; t_u = 30\text{ ms}.$		-	20	100	nA	
Input capacitance	C_{ies}	$V_{CE} = 10\text{ V}; V_{GE} = 0\text{ V}; f = 1\text{ MHz}; T_{vj} = 25^\circ\text{C}.$		-	44.00	-	nF	
Reverse transfer capacitance	C_{res}			-	1.30	-	nF	
Total gate charge	Q_G	$I_C = 450\text{ A}; V_{CE} = 920\text{ V}; V_{GE} = -15\dots+15\text{ V}.$		-	2450	2650	nC	
Internal gate resistance	R_{Gint}	$T_{vj} = 25^\circ\text{C}.$		-	1.60	-	Ω	
Turn-on delay time	$t_{d(on)}$	$V_{CE} = 920\text{ V}; V_{GE} = \pm 15\text{ V}; I_{Cmax} = 450\text{ A}; R_G = 3.0\text{ }\Omega; L_s = 56\text{ nH}.$	$T_{vj} = 25^\circ\text{C}$ $T_{vj} = 150^\circ\text{C}$	163 174	194 212	225 250	ns	
Rise time	t_{ri}		$T_{vj} = 25^\circ\text{C}$ $T_{vj} = 150^\circ\text{C}$	78 87	93 106	108 125	ns	
Turn-on energy	E_{on}		$T_{vj} = 25^\circ\text{C}$ $T_{vj} = 150^\circ\text{C}$	71.5 110.5	98.5 149.5	125.5 188.5	mJ	
Turn-off delay time	$t_{d(off)}$		$T_{vj} = 25^\circ\text{C}$ $T_{vj} = 150^\circ\text{C}$	484 601	583 710	682 819	ns	
Fall time	t_{fi}		$T_{vj} = 25^\circ\text{C}$ $T_{vj} = 150^\circ\text{C}$	332 498	394 584	456 670	ns	
Turn-off energy	E_{off}		$T_{vj} = 25^\circ\text{C}$ $T_{vj} = 150^\circ\text{C}$	82.5 119.5	99.0 143.0	115.5 166.5	mJ	
Collector-emitter threshold voltage	V_{CE0}		$V_{GE} = +15\text{ V}; T_{vj} = 150^\circ\text{C}; I_{CE1} = 125\text{ A}; I_{CE2} = 450\text{ A}; t_u = 1000\text{ }\mu\text{s}.$		0.92	0.97	1.02	V
On-State slope resistance (IGBT)	r_{CE0}				3.61	4.04	4.47	m Ω
Thermal resistance junction to case	$R_{th(j-c)}$		DC; $I_{CE} = 300\pm 50\text{ A}; I_{test} = 1.5\text{ A}; V_{GE} = +15\text{ V}.$		-	0.048	0.058	K/W
Inverse diode								
Forward voltage drop	V_F	$I_F = 450\text{ A}; V_{GE} = 0; t_u = 1000\text{ }\mu\text{s}.$	$T_{vj} = 25^\circ\text{C}$ $T_{vj} = 150^\circ\text{C}$	2.00 2.25	2.35 2.70	2.70 3.15	V V	
Reverse recovery time	t_{rr}	$V_{CE} = 920\text{ V}; V_{GE} = \pm 15\text{ V}; I_{Cmax} = 450\text{ A}; R_G = 3.0\text{ }\Omega; L_s = 56\text{ nH}.$	$T_{vj} = 25^\circ\text{C}$ $T_{vj} = 150^\circ\text{C}$	450 781	557 943	664 1105	ns ns	
Peak reverse current	I_{RM}		$T_{vj} = 25^\circ\text{C}$ $T_{vj} = 150^\circ\text{C}$	160 180	230 270	300 360	A A	
Recovered charge	Q_r		$T_{vj} = 25^\circ\text{C}$ $T_{vj} = 150^\circ\text{C}$	37.5 83.0	53.5 111.0	69.5 139.0	μC μC	
Reverse recovery energy	E_{rec}		$T_{vj} = 25^\circ\text{C}$ $T_{vj} = 150^\circ\text{C}$	23.5 48.5	33.5 66.5	43.5 84.5	mJ mJ	
Threshold voltage	$V_{(T0)}$		$T_{vj} = 150^\circ\text{C}; V_{GE} = 0; I_{CE1} = 125\text{ A}; I_{CE2} = 450\text{ A}; t_u = 1000\text{ }\mu\text{s}.$		0.92	0.94	0.96	V
Forward slope resistance	r_T				3.62	3.93	4.24	m Ω
Thermal resistance junction to case	$R_{th(jc-D)}$	DC; $I_{CE} = 300\pm 50\text{ A}; I_{test} = 1.5\text{ A}; V_{GE} = +15\text{ V}.$		-	0.096	0.101	K/W	

Module							
Pin resistance	R_{Pxy}	$T_{vj} = 25^{\circ}\text{C}$.	$R_{P10/11-3}$	-	0.92	1.00	m Ω
			$R_{P10/11-4}$	-	0.59	1.00	
Parasitic inductance between terminals	L_{Pce}			-	22	-	nH
Thermistor resistance	R_{t25}	$T_{vj} = 25^{\circ}\text{C}$	4850	-	6225	Ω	
		$T_{vj} = 100^{\circ}\text{C}$	475	-	554		
Coefficient of temperature sensitivity	$B_{25/50}$	$R_2 = R_{25} \exp [B_{25/50} (1/T_2 - 1/T_1)]$, $T_1 = 298,15 \text{ K}$	-	3375	-	κ	
Thermal resistance case to heatsink	R_{thCH}	per module	-	0.009	0.014	K/W	
Mounting torque for screws to heatsink	M_s	to heatsink M5	3	-	6	N*m	
Mounting torque for terminal screws	M_t	to terminals M6	3	-	6	N*m	
Weight	W		-	360	-	g	

" - " — data will be refined as additional tests are conducted and statistics are collected.

Notes:

- Insulating material operating temperature 125°C max;
- Case temperature 125°C max;
- The recommended operating junction temperature $T_{vj\ op} = -40\dots+150^{\circ}\text{C}$.

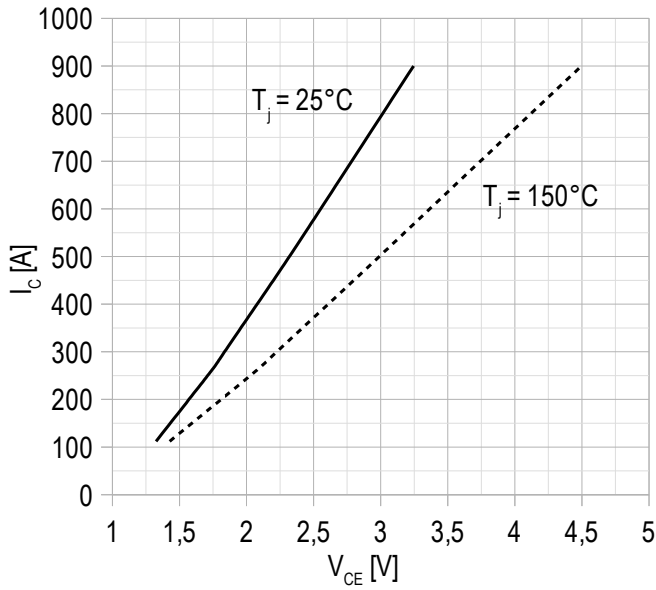
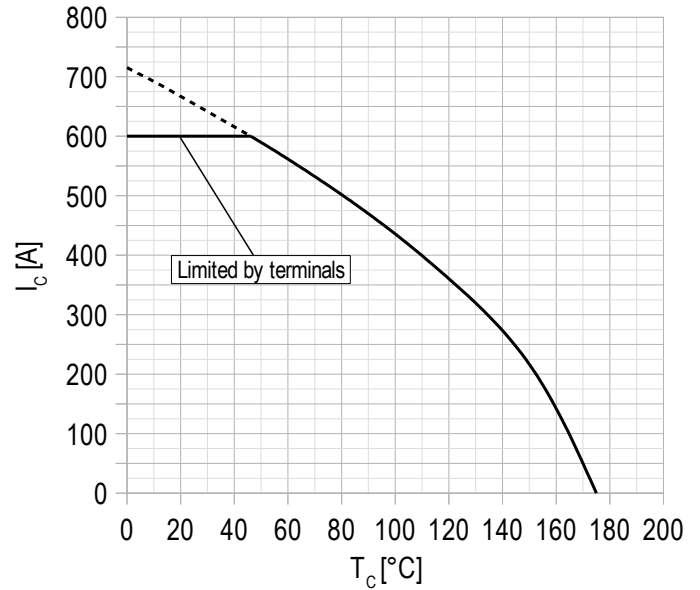
Chart 1 – typ. output characteristic, IGBT.

 $V_{GE} = +15 \text{ V.}$
Chart 2 – max. rated current vs temperature.

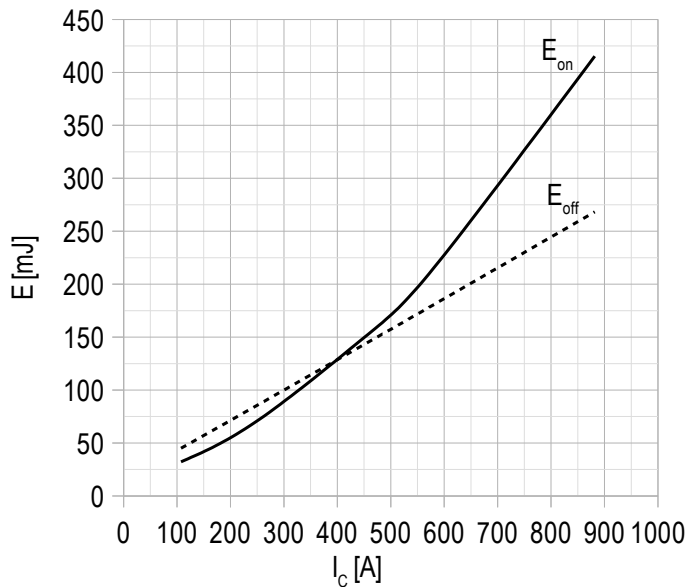
DC;
 $V_{GE} = +15 \text{ V;}$
 $T_{vj(max)} = 175^\circ\text{C.}$

Chart 3 – typ. turn-on/off energy vs rated current, IGBT.

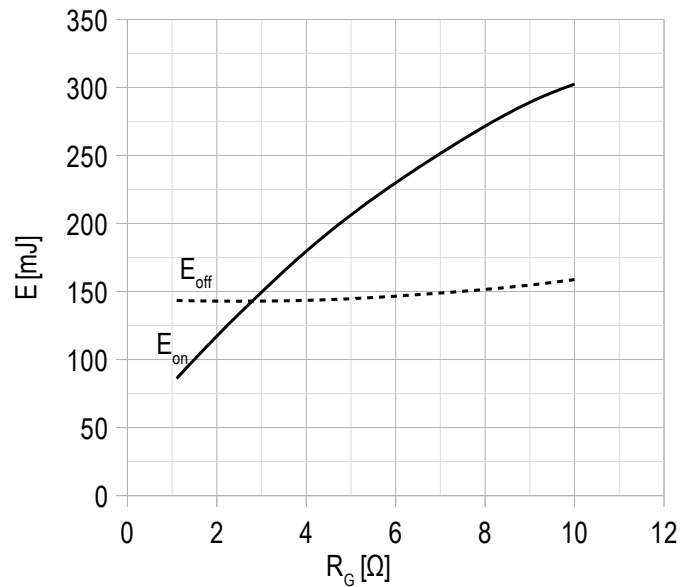
$V_{CE} = 920 \text{ V;}$
 $V_{GE} = \pm 15 \text{ V;}$
 $R_G = 3 \Omega;$
 $L_s = 56 \text{ nH;}$
 $T_{vj(max)} = 150^\circ\text{C.}$

Chart 4 – typ. turn-on/off energy vs gate resistance, IGBT.

$V_{CE} = 920 \text{ V;}$
 $V_{GE} = \pm 15 \text{ V;}$
 $I_{Cmax} = 450 \text{ A;}$
 $L_s = 56 \text{ nH;}$
 $T_{vj(max)} = 150^\circ\text{C.}$

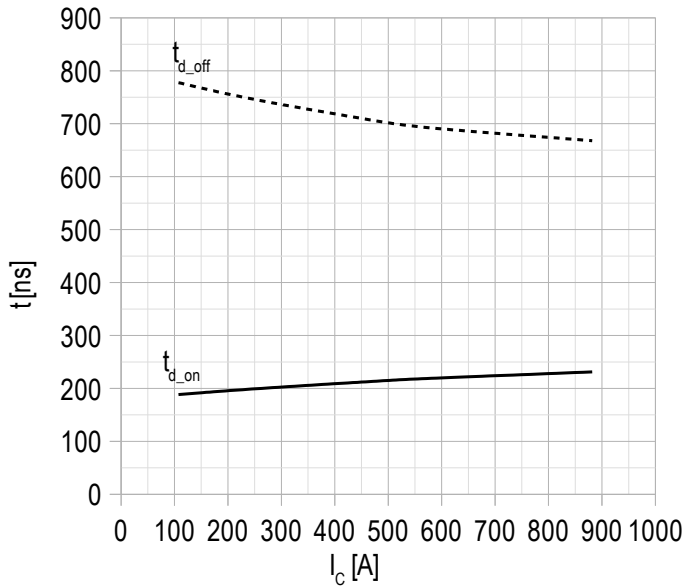
Chart 5 – typ. switching times vs rated current, IGBT.

$V_{CE} = 920 \text{ V};$
 $V_{GE} = \pm 15 \text{ V};$
 $R_G = 3 \Omega;$
 $L_s = 56 \text{ nH};$
 $T_{vj(max)} = 150^\circ\text{C}.$

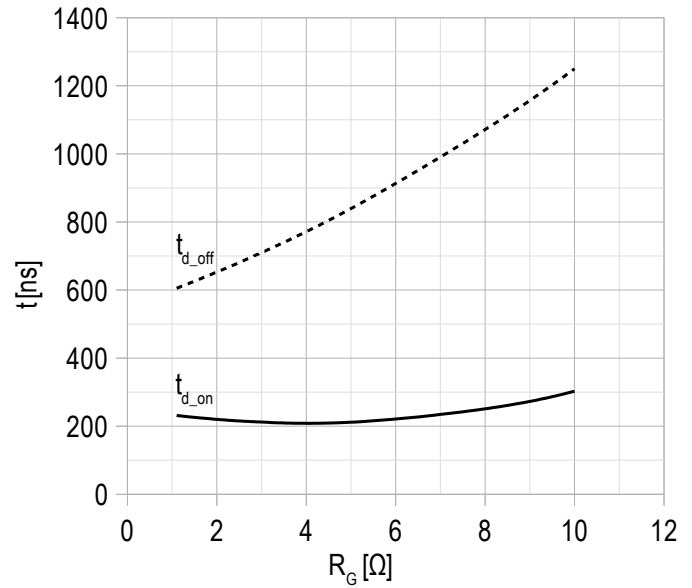
Chart 6 – typ. switching times vs gate resistance, IGBT.

$V_{CE} = 920 \text{ V};$
 $V_{GE} = \pm 15 \text{ V};$
 $I_{Cmax} = 450 \text{ A};$
 $L_s = 56 \text{ nH};$
 $T_{vj(max)} = 150^\circ\text{C}.$

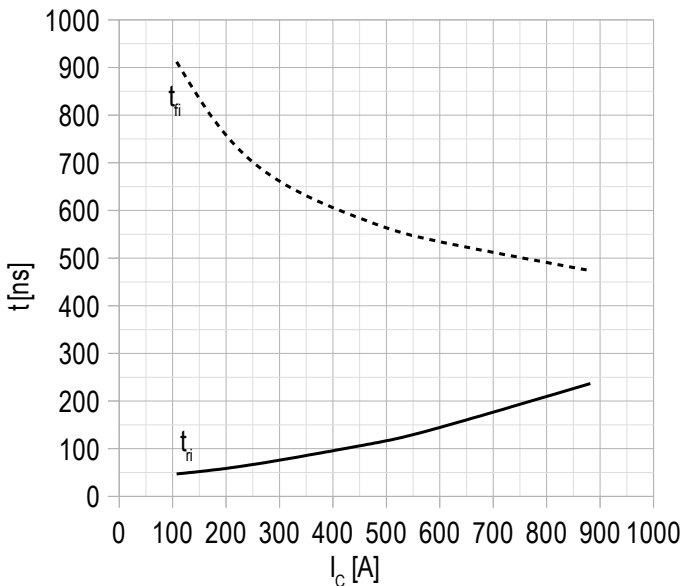
Chart 7 – typ. switching times vs rated current, IGBT.

$V_{CE} = 920 \text{ V};$
 $V_{GE} = \pm 15 \text{ V};$
 $R_G = 3 \Omega;$
 $L_s = 56 \text{ nH};$
 $T_{vj(max)} = 150^\circ\text{C}.$

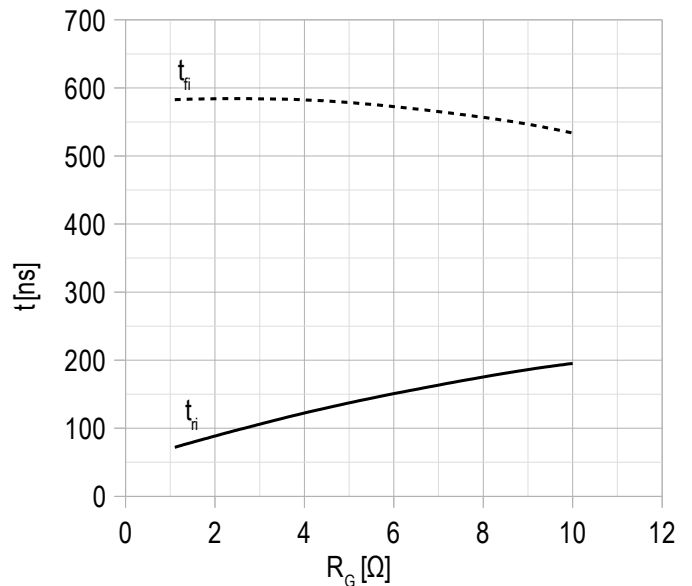
Chart 8 – typ. switching times vs gate resistance, IGBT.

$V_{CE} = 920 \text{ V};$
 $V_{GE} = \pm 15 \text{ V};$
 $I_{Cmax} = 450 \text{ A};$
 $L_s = 56 \text{ nH};$
 $T_{vj(max)} = 150^\circ\text{C}.$

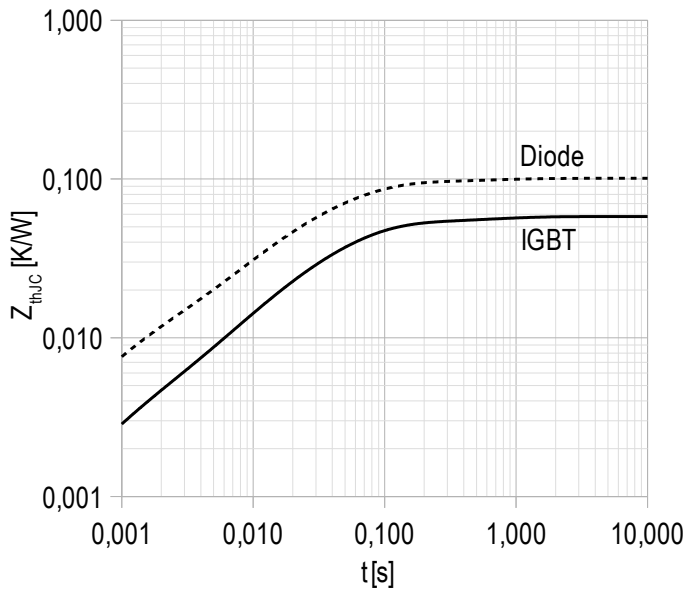
Chart 9 – max. transient thermal impedance .

Single pulse;
 $V_{GE} = +15\text{ V}$.

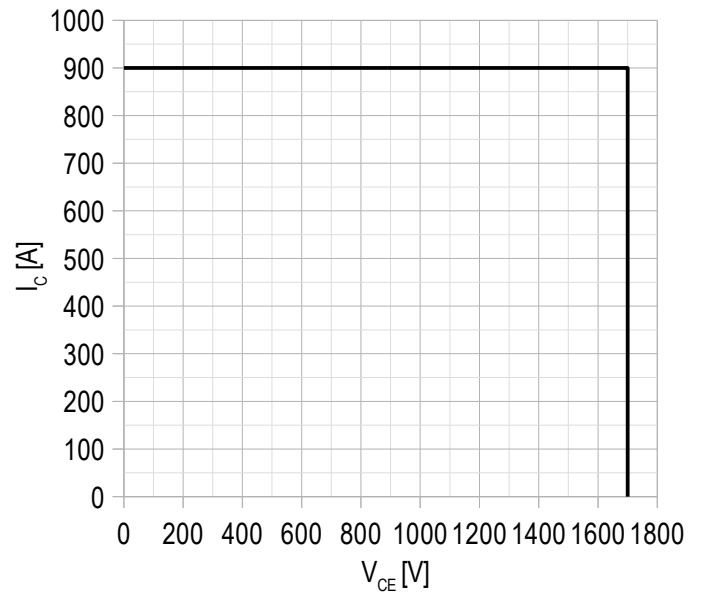
Chart 10 – RBSOA.

$V_{CE\text{ max}} = 1700\text{ V}$;
 $V_{GE} = \pm 15\text{ V}$;
 $I_{C\text{ max}} = 2 \cdot I_{C\text{ nom}}$;
 $R_G = 3\ \Omega$;
 $L_s = 56\text{ nH}$.

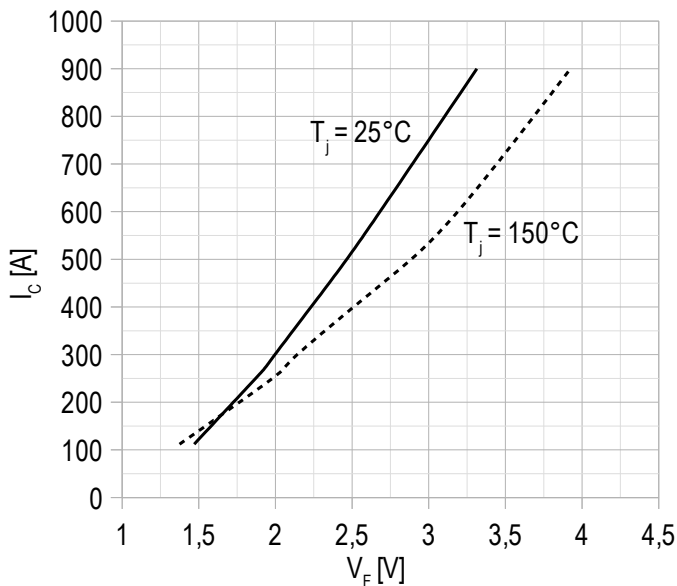
Chart 11 – typ. output characteristic, FRD.

$V_{GE} = 0\text{ V}$.

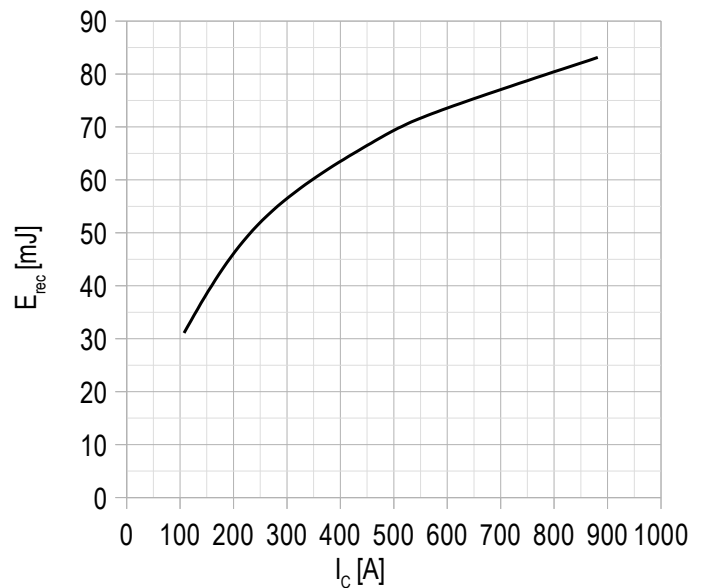
Chart 12 – typ. switching losses vs rated current, FRD.

$V_{GE} = \pm 15\text{ V}$;
 $V_{CE} = 920\text{ V}$;
 $L_s = 56\text{ nH}$;
 $R_{G\text{ on}} = 3\ \Omega$;
 $T_{vj\text{ (max)}} = 150^\circ\text{C}$.

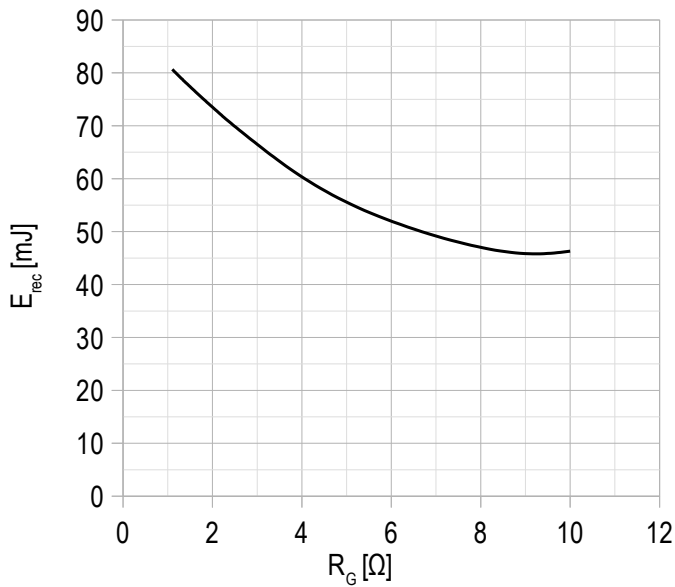
Chart 13 – typ. switching losses vs gate resistance, FRD.

$V_{GE} = \pm 15$ V;
 $V_{CE} = 920$ V;
 $I_{Cmax} = 450$ A;
 $L_s = 56$ nH;
 $T_{vj(max)} = 150^\circ\text{C}$.

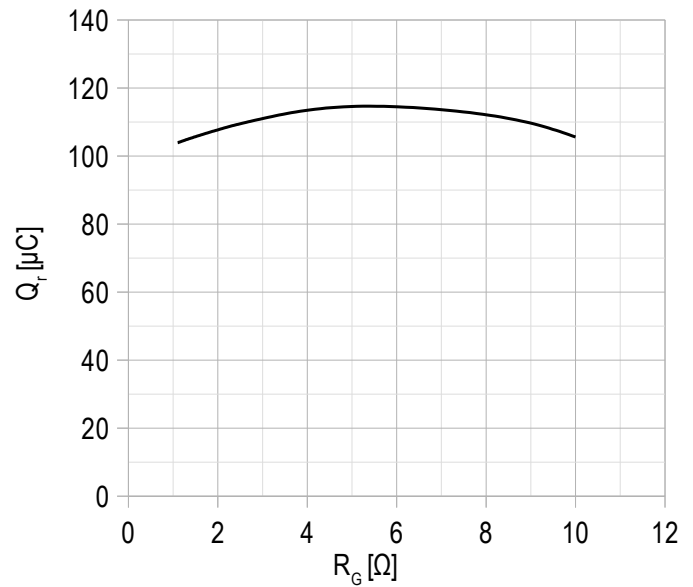
Chart 14 – typ. reverse recovered charge vs gate resistance, FRD.

$V_{GE} = \pm 15$ V;
 $V_{CE} = 920$ V;
 $I_{Cmax} = 450$ A;
 $L_s = 56$ nH;
 $T_{vj(max)} = 150^\circ\text{C}$.

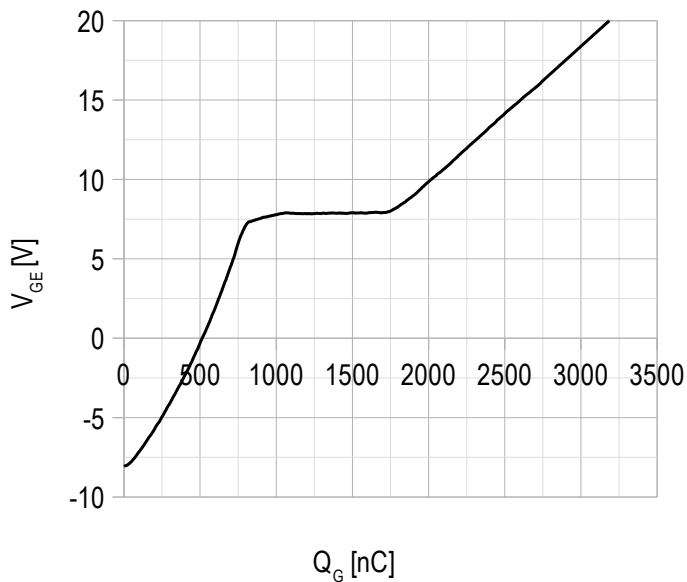
Chart 15 – typ. gate charge characteristic.

$I_C = 450$ A;
 $V_{CE} = 920$ V;
 $V_{GE} = -15 \div 15$ V.

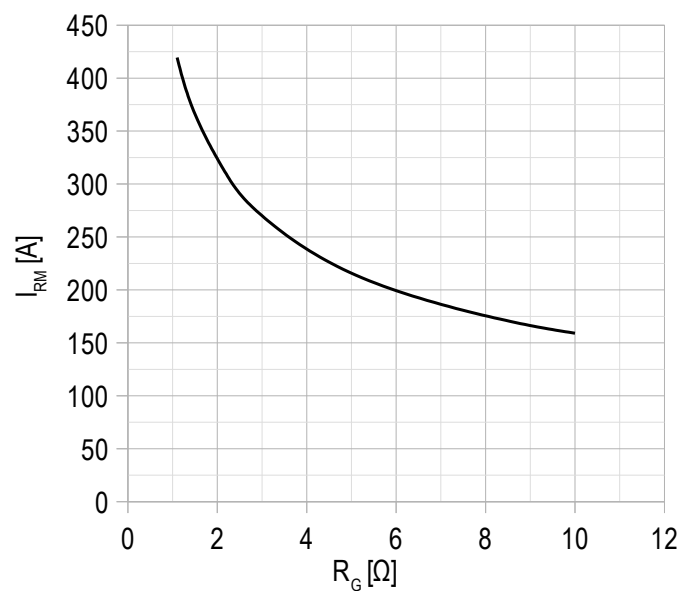
Chart 16 – typ. reverse recovery current vs gate resistance FRD.

$V_{CE} = 920$ V;
 $V_{GE} = \pm 15$ V;
 $L_s = 56$ nH.
 $T_{vj(max)} = 150^\circ\text{C}$.

Chart 17 – max. rated current vs frequency.

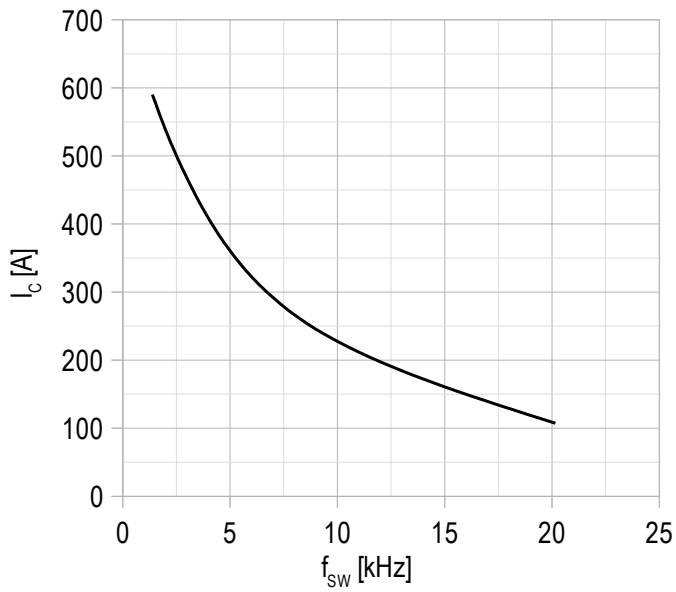

Duty cycle 50%;
 $V_{CE} = 600$ V;
 $T_c = 80$ °C;
 $T_{vj(max)} = 175$ °C.

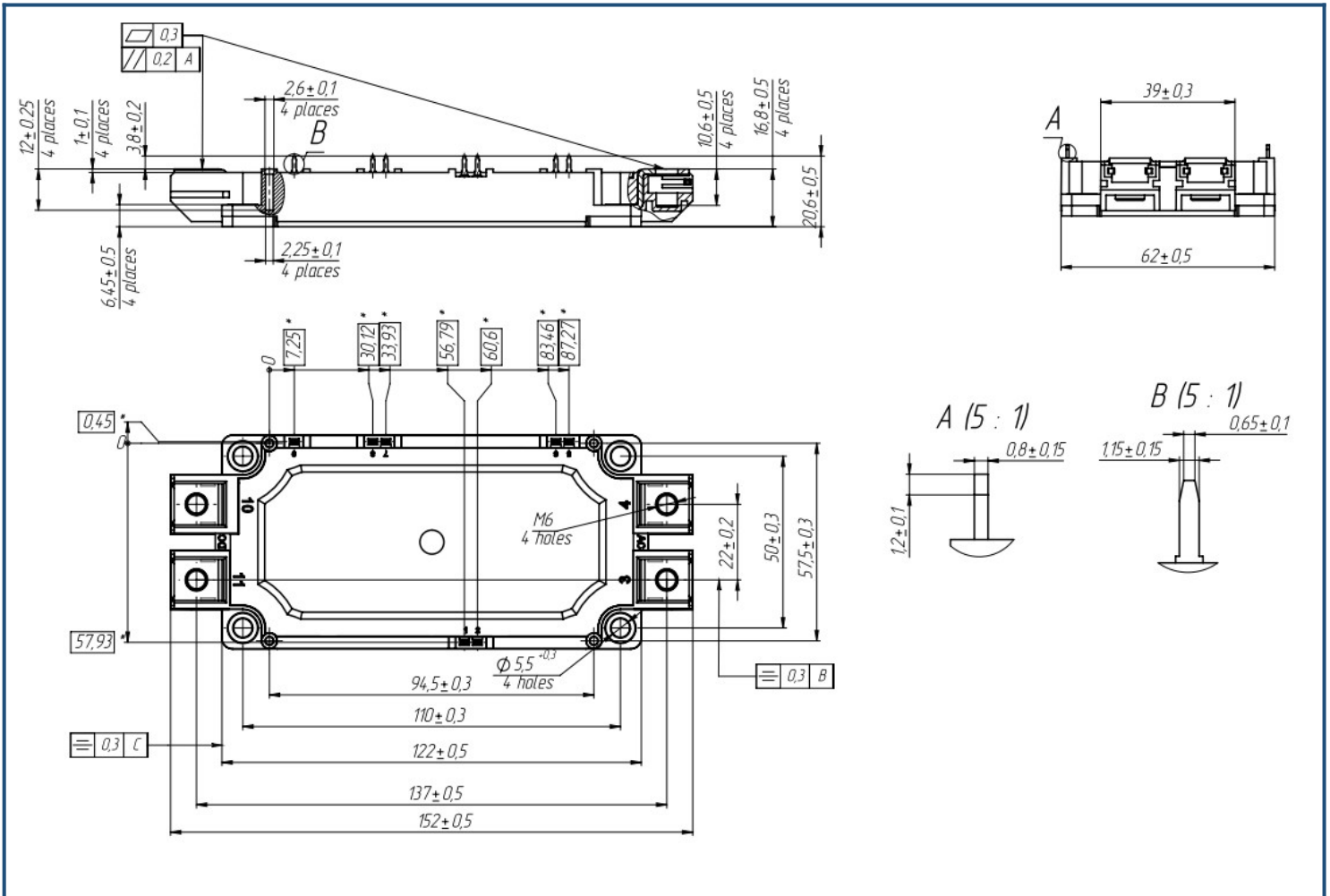
Overall dimensions: Package type – DA

Part numbering guide

MIDA	-	HB	17	SA	-	450	N	
MIDA								IGBT module package type: DA
		HB						2 switches as Half-Bridge
			17					Voltage rating (V _{CES} /100)
				SA				IGBT+FRD chipset modification
						450		Current Rating
							N	Climatic version: normal climate

The information contained herein is protected by Copyright. In the interest of product improvement, Proton-Electrotex reserves the right to change datasheet without notice.