

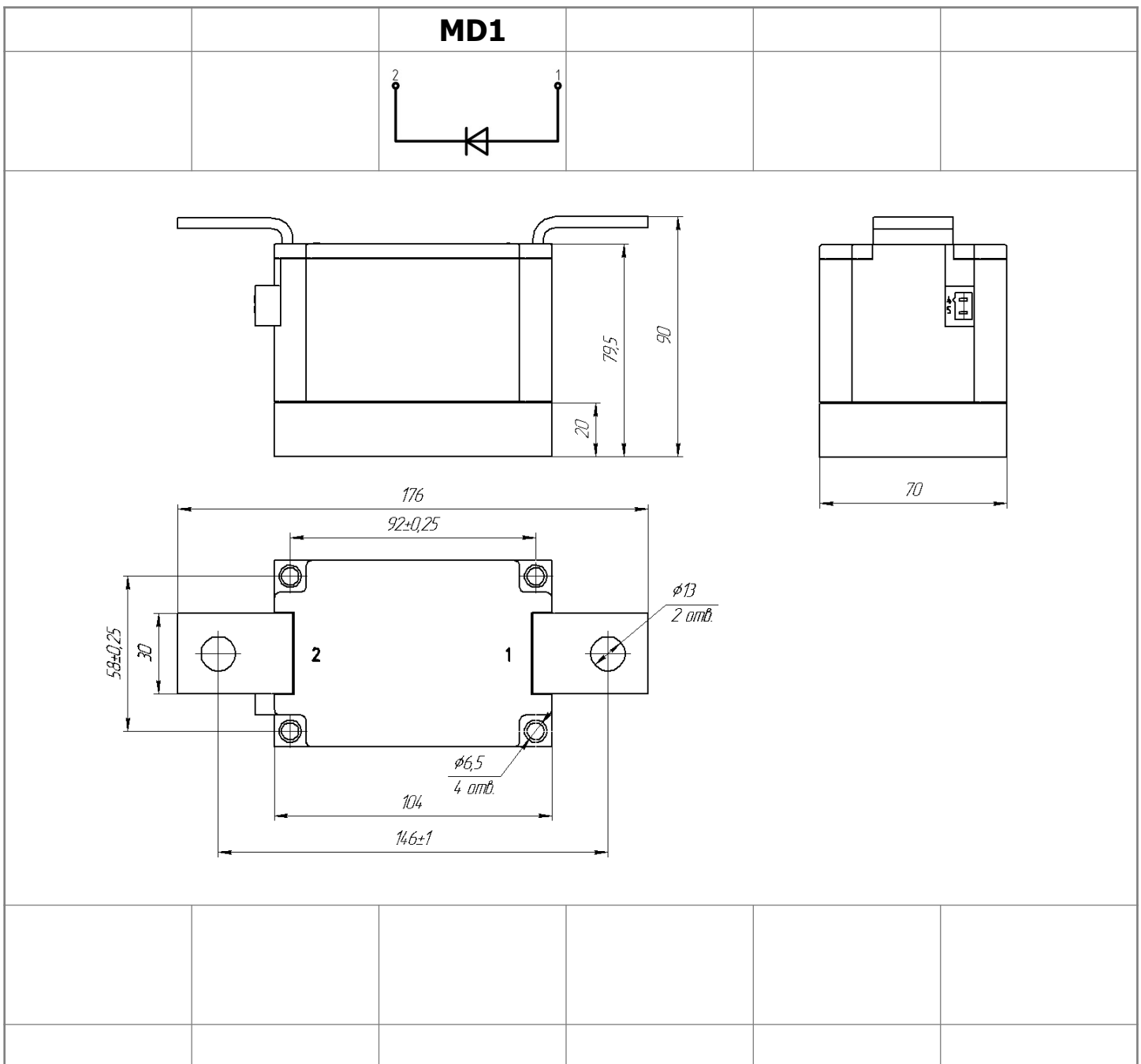

**Single Diode Module
For Phase Control
MD1-1280-22-E**

Electrically isolated base plate
Industrial standard package
Simplified mechanical design, rapid assembly
Pressure contact

Average forward current	I_{FAV}	1280 A
Repetitive peak reverse voltage	V_{RRM}	2000 ÷ 2200 V
V_{RRM}, V	2000	2200
Voltage code	20	22
$T_j, ^\circ C$	- 40 ÷ 160	



All dimensions in millimeters (inches)

MAXIMUM ALLOWABLE RATINGS

Symbols and parameters		Units	Values	Test conditions
ON-STATE				
I_{FAV}	Average forward current	A	1280	$T_c = 100\text{ }^\circ\text{C}$; 180° half-sine wave; 50 Hz
I_{FRMS}	RMS forward current	A	2010	
I_{FSM}	Surge forward current	kA	40.0 48.0	$T_j = T_{j\text{ max}}$ $T_j = 25\text{ }^\circ\text{C}$ 180° half-sine wave; $t_p = 10\text{ ms}$; single pulse; $V_R = 0\text{ V}$;
			42.0 50.0	$T_j = T_{j\text{ max}}$ $T_j = 25\text{ }^\circ\text{C}$ 180° half-sine wave; $t_p = 8.3\text{ ms}$; single pulse; $V_R = 0\text{ V}$;
I^2t	Safety factor	$A^2s \cdot 10^3$	8000 11500	$T_j = T_{j\text{ max}}$ $T_j = 25\text{ }^\circ\text{C}$ 180° half-sine wave; $t_p = 10\text{ ms}$; single pulse; $V_R = 0\text{ V}$;
			7300 10300	$T_j = T_{j\text{ max}}$ $T_j = 25\text{ }^\circ\text{C}$ 180° half-sine wave; $t_p = 8.3\text{ ms}$; single pulse; $V_R = 0\text{ V}$;
BLOCKING				
V_{RRM}	Repetitive peak reverse voltages	V	2000÷2200	$T_{j\text{ min}} < T_j < T_{j\text{ max}}$; 180° half-sine wave; 50 Hz
V_{RSM}	Non-repetitive peak reverse voltages	V	2100÷2300	$T_{j\text{ min}} < T_j < T_{j\text{ max}}$; 180° half-sine wave; single pulse;
V_R	Reverse continuous voltages	V	$0.6 \cdot V_{RRM}$	$T_j = T_{j\text{ max}}$;
THERMAL				
T_{stg}	Storage temperature	$^\circ\text{C}$	- 40 ÷ 50	
T_j	Operating junction temperature	$^\circ\text{C}$	- 40 ÷ 160	
$T_{c\text{ op}}$	Operating temperature	$^\circ\text{C}$	- 40 ÷ 125	
MECHANICAL				
a	Acceleration under vibration	m/s^2	50	

CHARACTERISTICS

Symbols and parameters		Units	Values	Conditions
ON-STATE				
V_{FM}	Peak forward voltage, max	V	1.30	$T_j = 25\text{ }^\circ\text{C}$; $I_{FM} = 3140\text{ A}$
$V_{F(TO)}$	Forward threshold voltage, max	V	0.80	$T_j = T_{j\text{ max}}$;
r_T	Forward slope resistance, max	$\text{m}\Omega$	0.100	$0.5 \pi I_{FAV} < I_T < 1.5 \pi I_{FAV}$
BLOCKING				
I_{RRM}	Repetitive peak reverse current, max	mA	70	$T_j = T_{j\text{ max}}$; $V_R = V_{RRM}$
SWITCHING				
Q_{rr}	Total recovered charge, max	μC	3710	$T_j = T_{j\text{ max}}$; $I_{FM} = 1280\text{ A}$; $di_R/dt = -10\text{ A}/\mu\text{s}$; $V_R = 100\text{ V}$
t_{rr}	Reverse recovery time, max	μs	33	
I_{rrm}	Reverse recovery current, max	A	225	
THERMAL				
R_{thjc}	Thermal resistance, junction to case			180° half-sine wave, 50 Hz
	per module	$^\circ\text{C}/\text{W}$	0.0420	
R_{thch}	Thermal resistance, case to heatsink			
	per module	$^\circ\text{C}/\text{W}$	0.0100	
INSULATION				
V_{ISOL}	Insulation test voltage	kV	3.00	Sine wave, 50 Hz; RMS
			3.60	
MECHANICAL				
M_1	Mounting torque (M6) ¹⁾	Nm	6.00	Tolerance $\pm 15\%$
M_2	Terminal connection torque (M12) ¹⁾	Nm	18.00	Tolerance $\pm 10\%$
w	Weight, max	g	2250	

PART NUMBERING GUIDE						NOTES				
MD	1	-	1280	-	22	-	E	-	N	
1	2		3		4		5		6	
1. MD - Rectifier Diode 2. Circuit Schematic 3. Average Forward Current, A 4. Voltage Code 5. Package Type (M.E) 6. Ambient Conditions: N – Normal										1) The screws must be lubricated

The information contained herein is confidential and protected by Copyright.
 In the interest of product improvement, Proton-Electrotex reserves the right to change data sheet without notice.

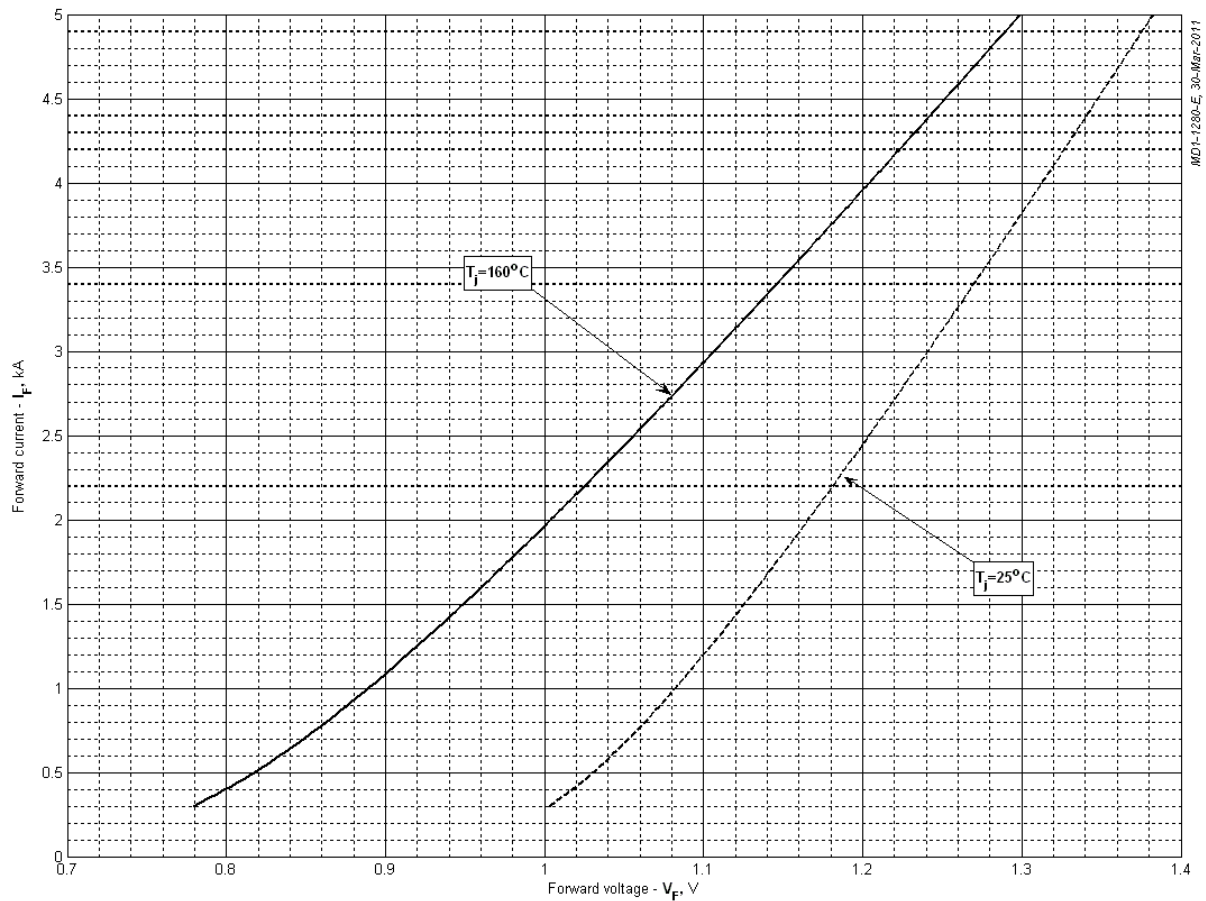

Fig 1 – On-state characteristics of Limit device

Analytical function for On-state characteristic:

$$V_F = A + B \cdot i_F + C \cdot \ln(i_F + 1) + D \cdot \sqrt{i_F}$$

	Coefficients	
	$T_j = 25^\circ\text{C}$	$T_j = T_{j \max}$
A	0.886039	0.610956
B	0.034063	0.042827
C	-0.152271	-0.221253
D	0.267739	0.389031

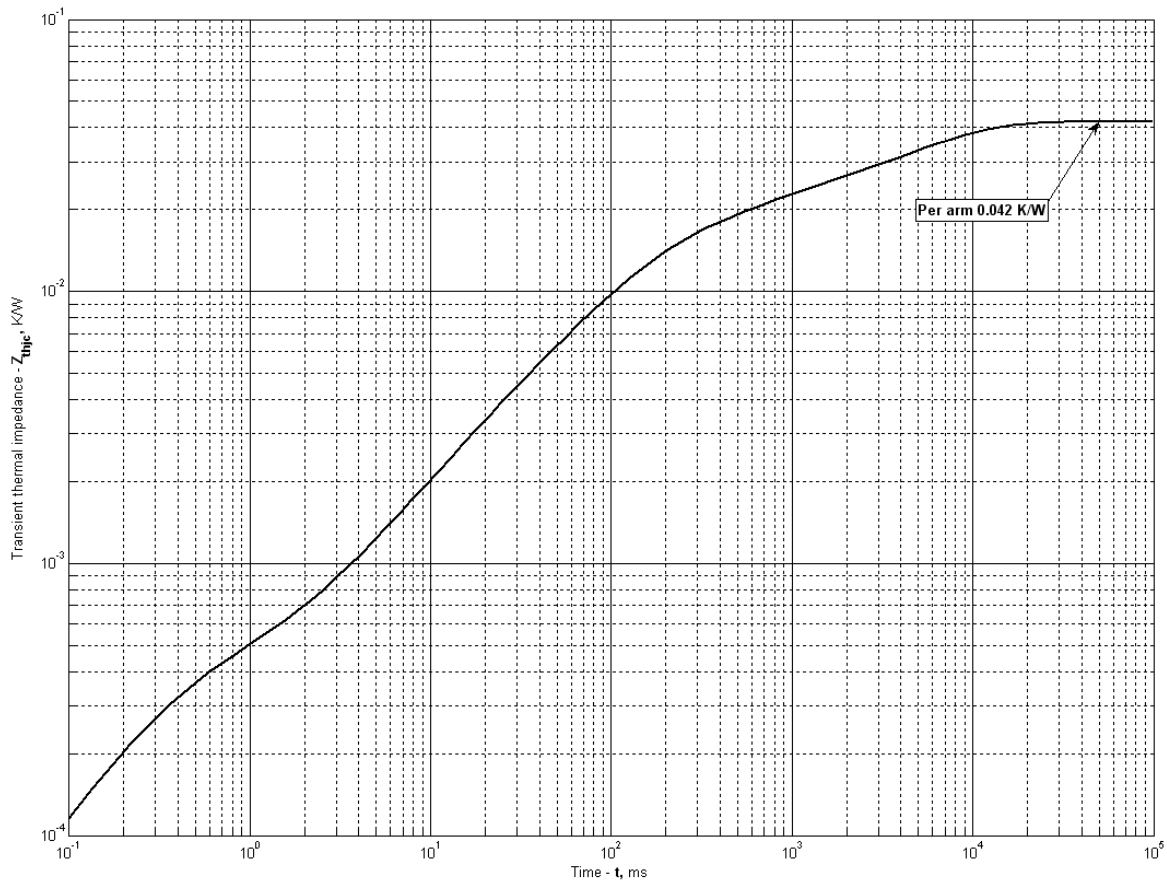

Fig 2 – Transient thermal impedance

Analytical function for Transient thermal impedance junction to case Z_{thjc} for DC:

$$Z_{thjc} = \sum_{i=1}^n R_i \left(1 - e^{-\frac{t}{\tau_i}} \right)$$

Where $i = 1$ to n , n is the number of terms in the series.

t = Duration of heating pulse in seconds.

Z_{thjc} = Thermal resistance at time t .

R_i = Amplitude of p_{th} term.

τ_i = Time constant of r_{th} term.

i	1	2	3	4	5	6
R_i, K/W	0.02105	0.005931	0.009502	0.004252	0.001006	0.0003132
τ_i, s	5.887	0.7389	0.1616	0.08215	0.01267	0.0002712

Transient thermal impedance junction to case Z_{thjc} model (see Fig. 2)

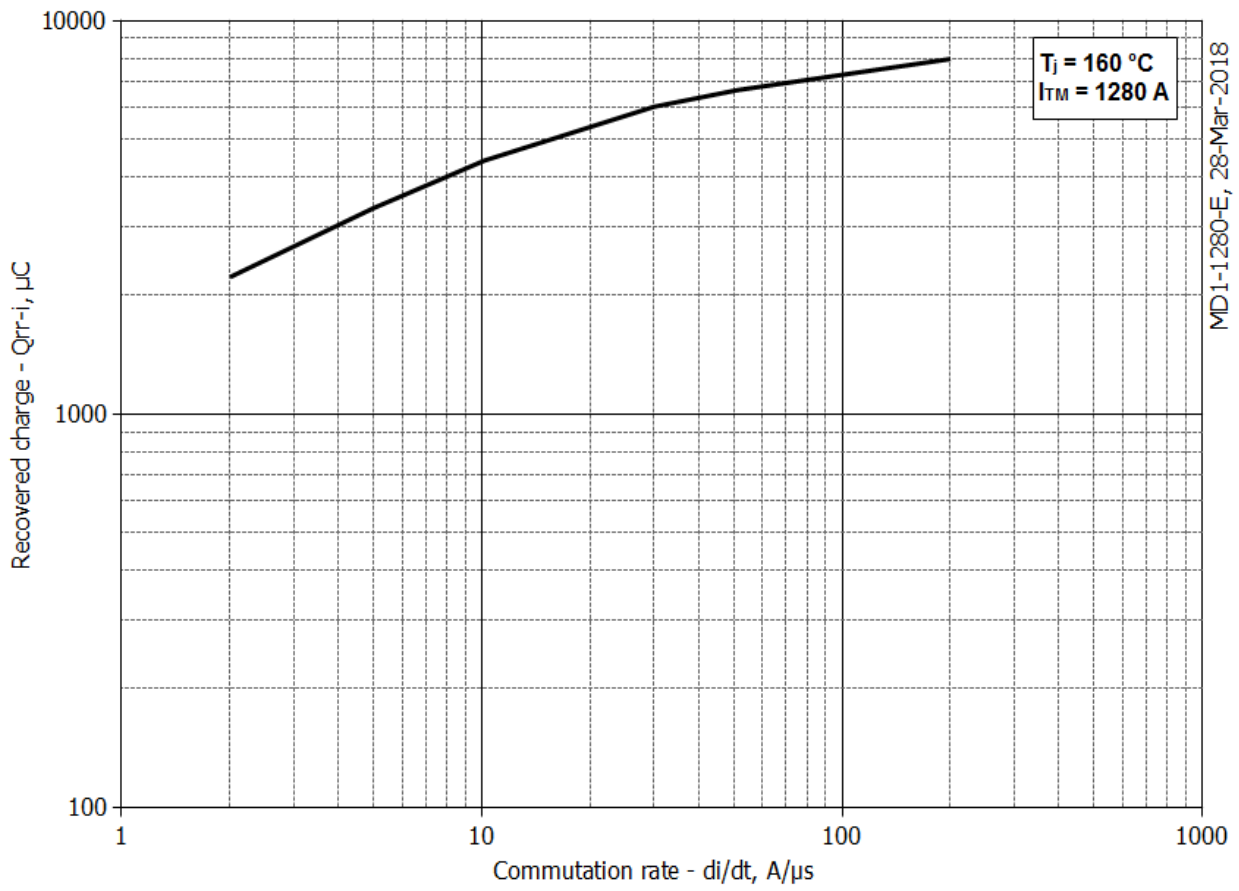

Fig 3 – Total recovered charge, Q_{rr-i} (integral)

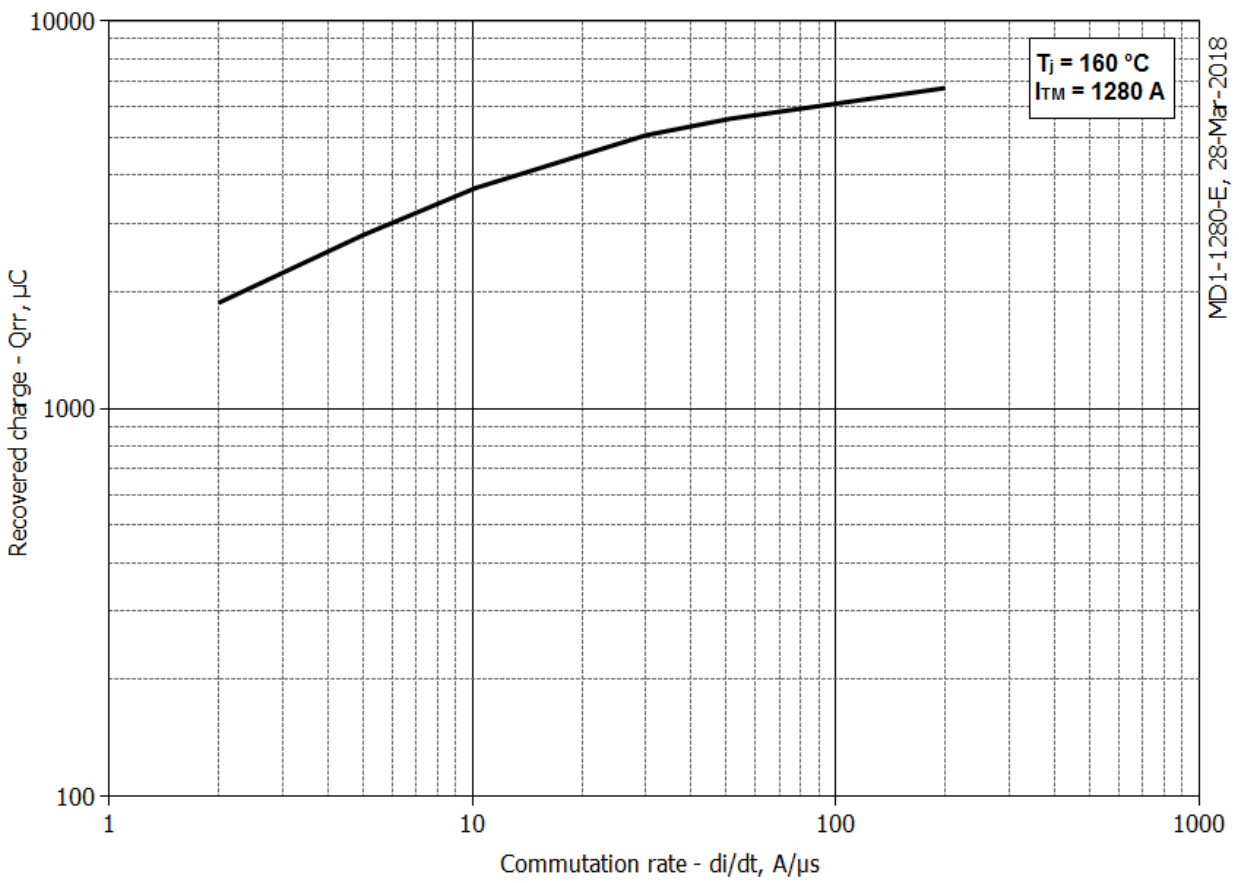

Fig 4 - Recovered charge, Q_{rr} (25% chord)

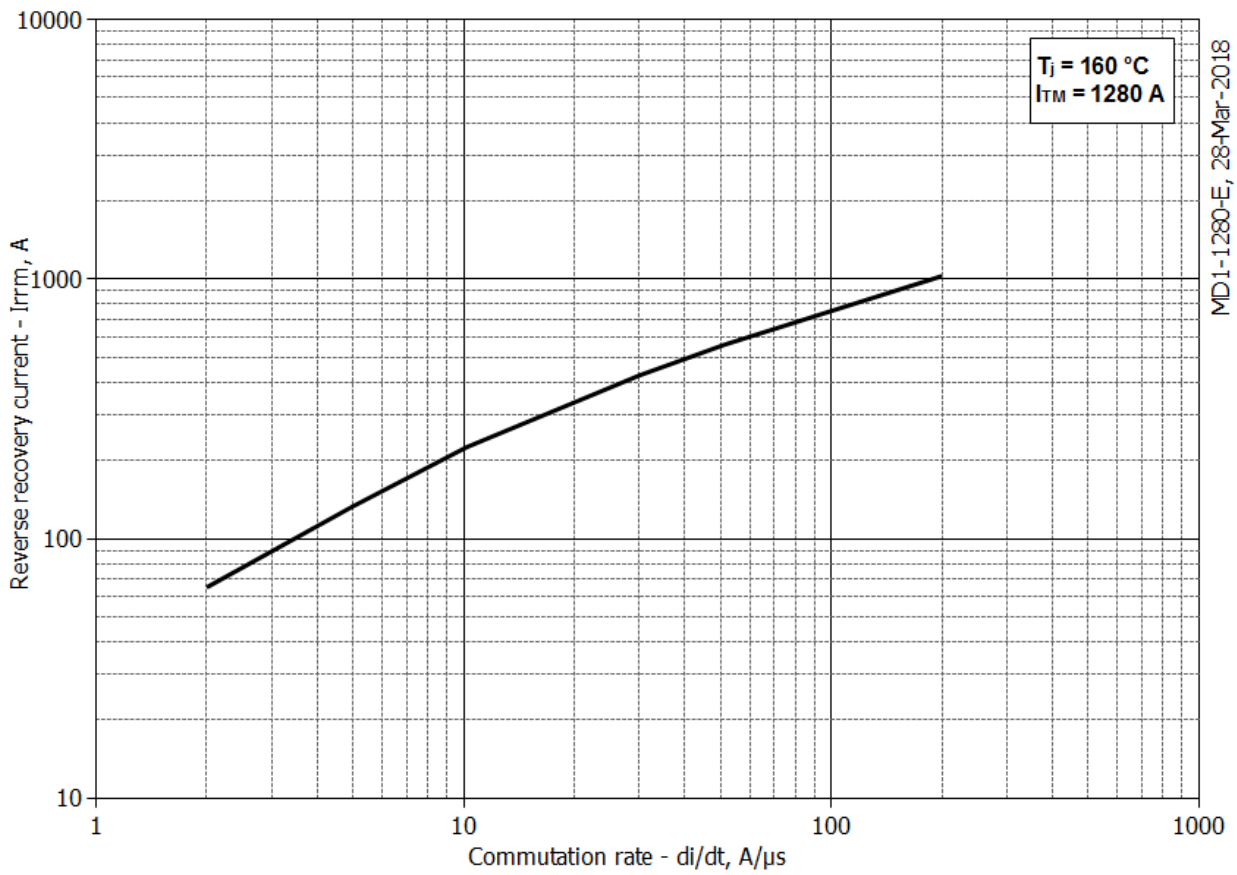

Fig 5 – Peak reverse recovery current, I_{rrm}

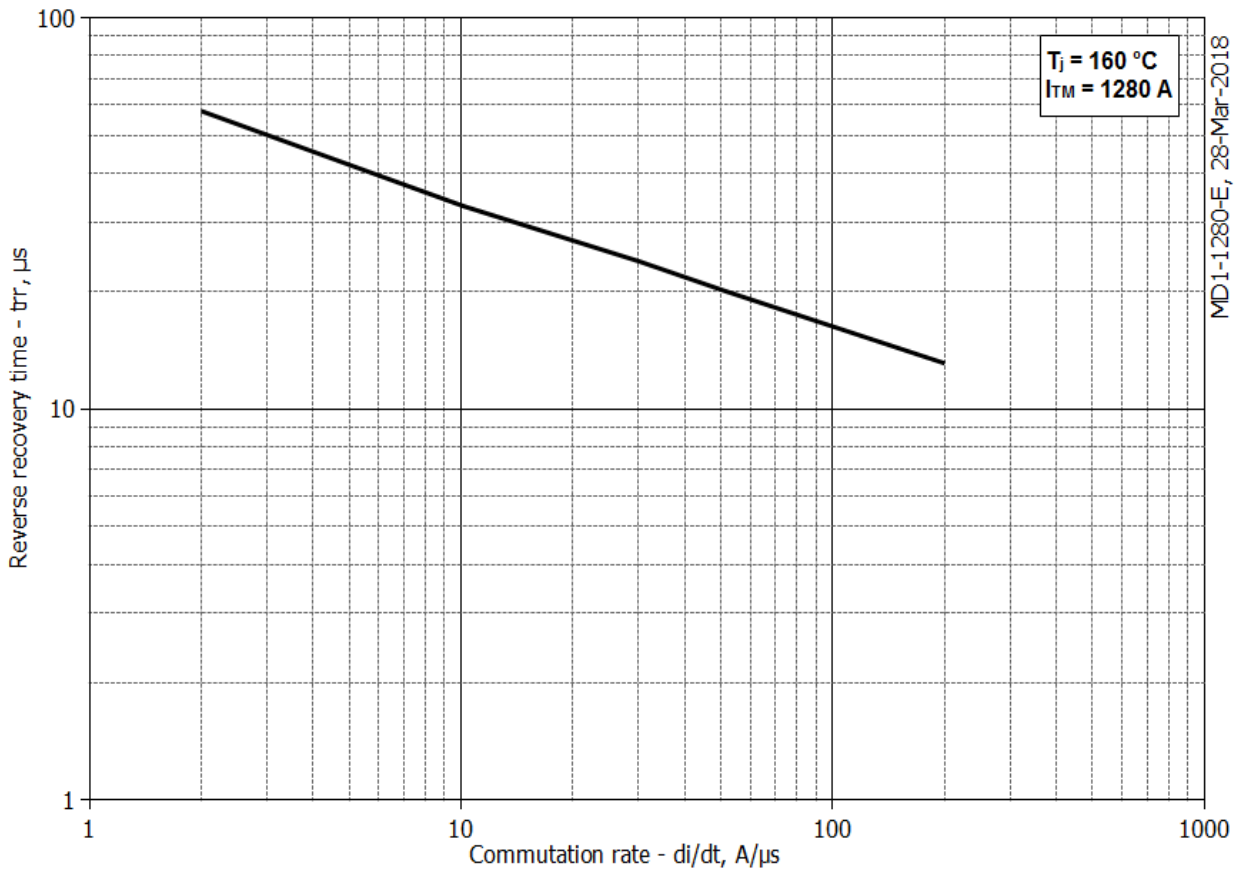

Fig 6 – Maximum recovery time, t_{rr} (25% chord)

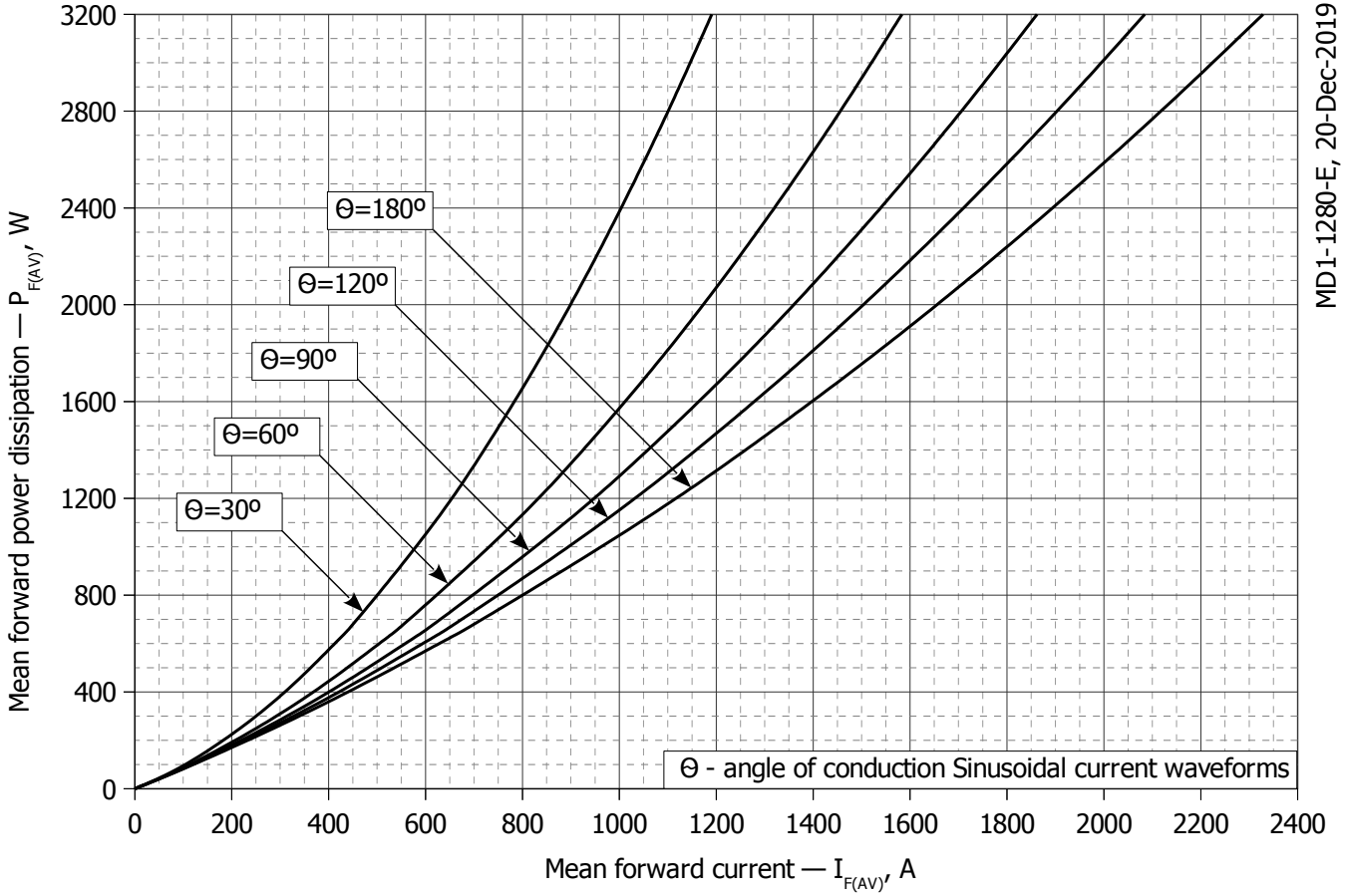

Fig 7 – On-state power loss (sinusoidal current waveforms)

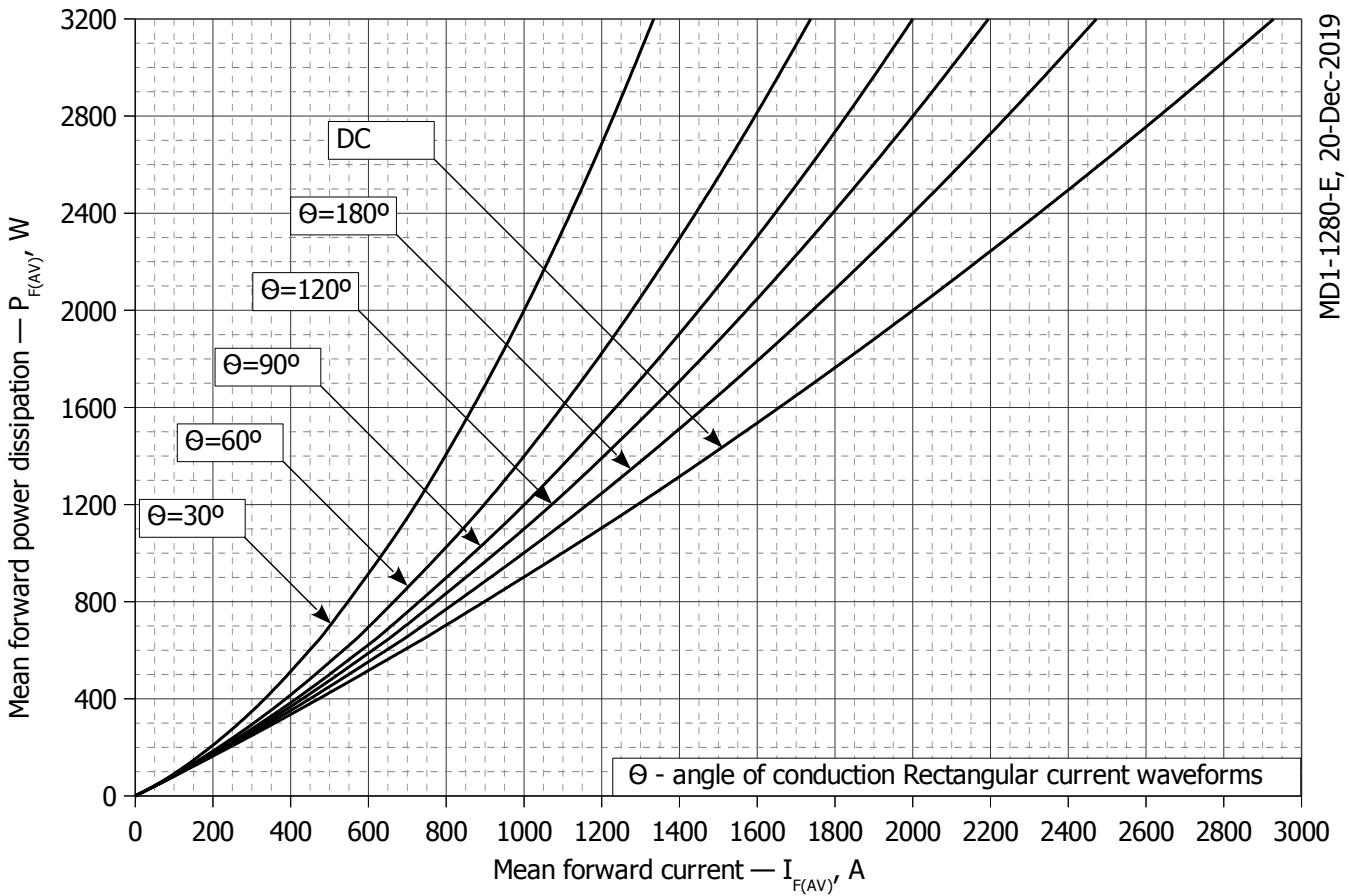

Fig 8 – On-state power loss (rectangular current waveforms)

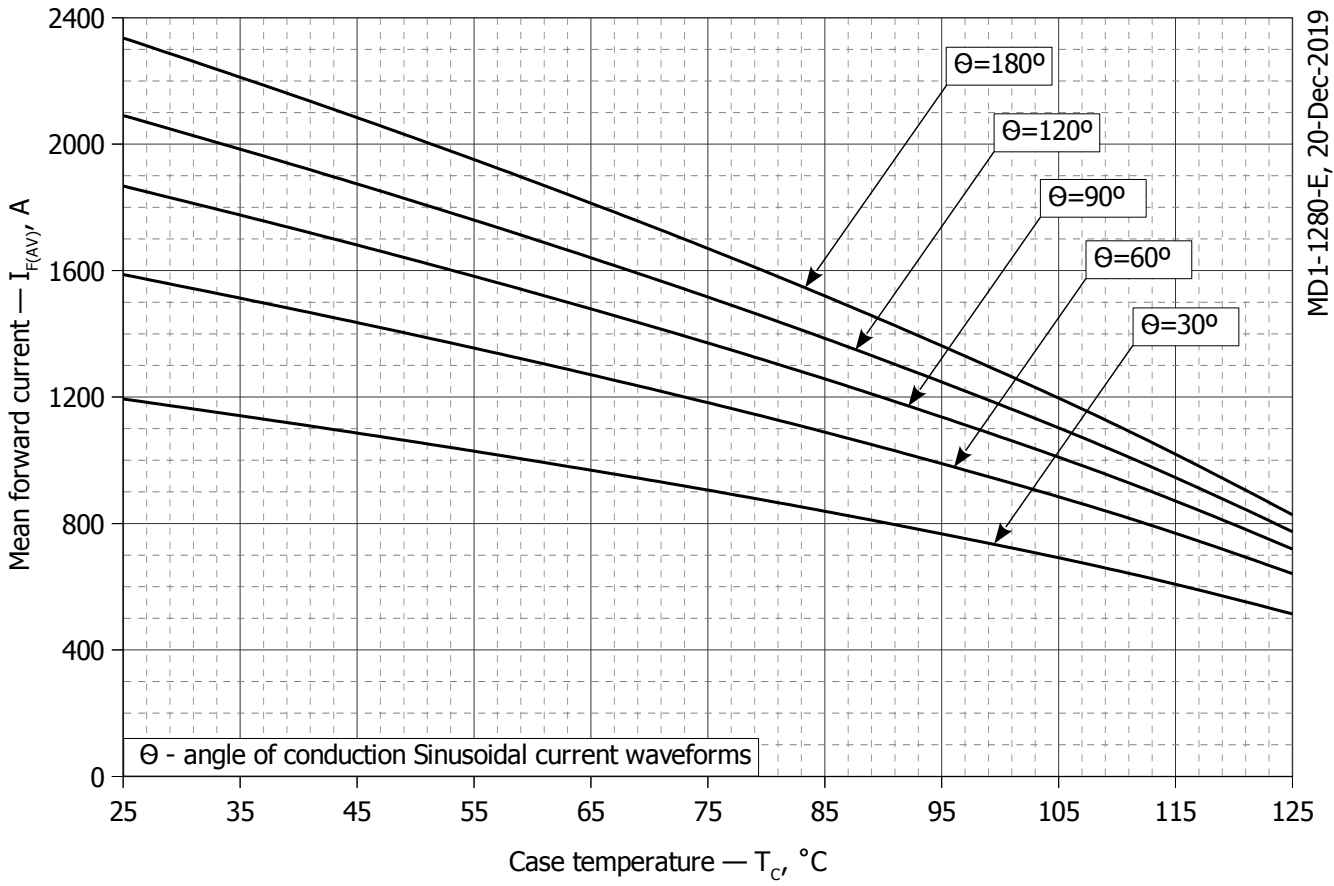

Fig 9 – Maximum case temperature DSC (sinusoidal current waveforms)

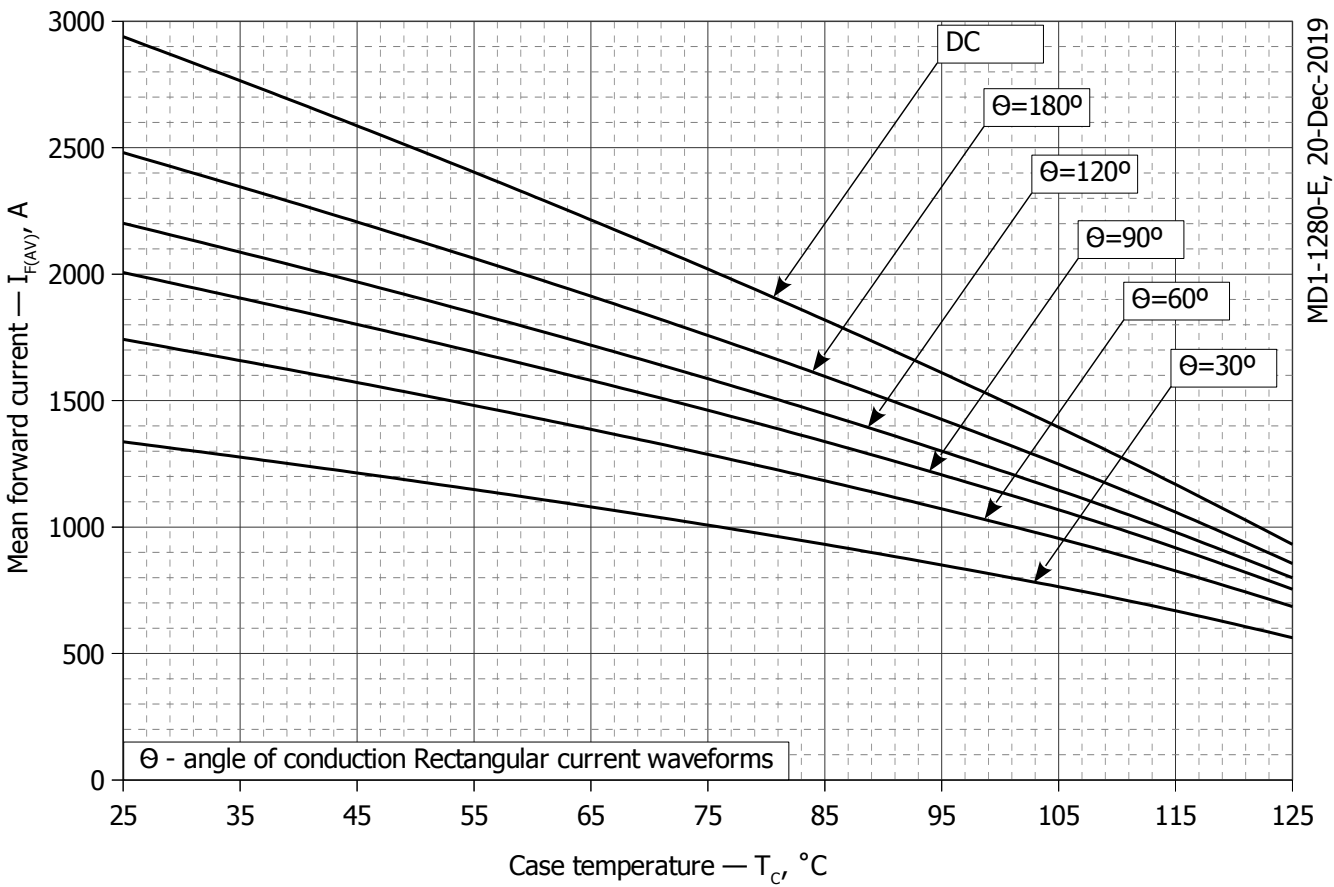

Fig 10 – Maximum case temperature DSC (rectangular current waveforms)

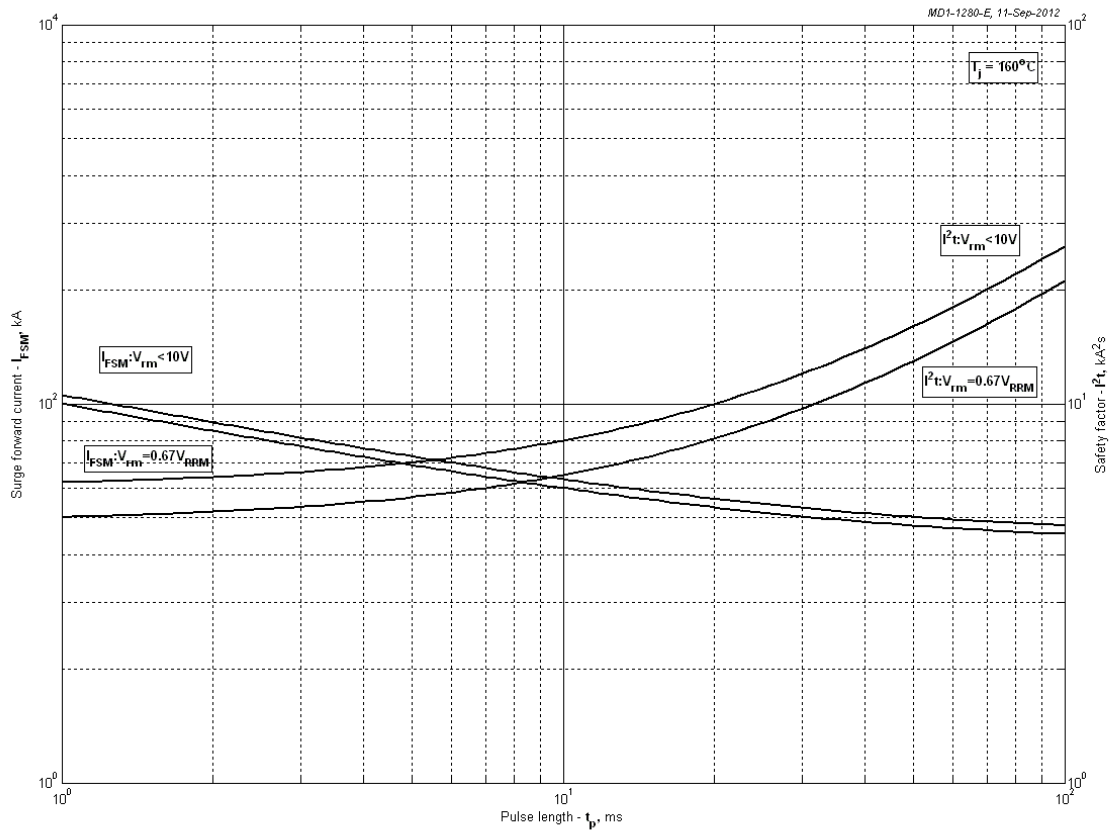

Fig 11 – Maximum surge and I^2t ratings

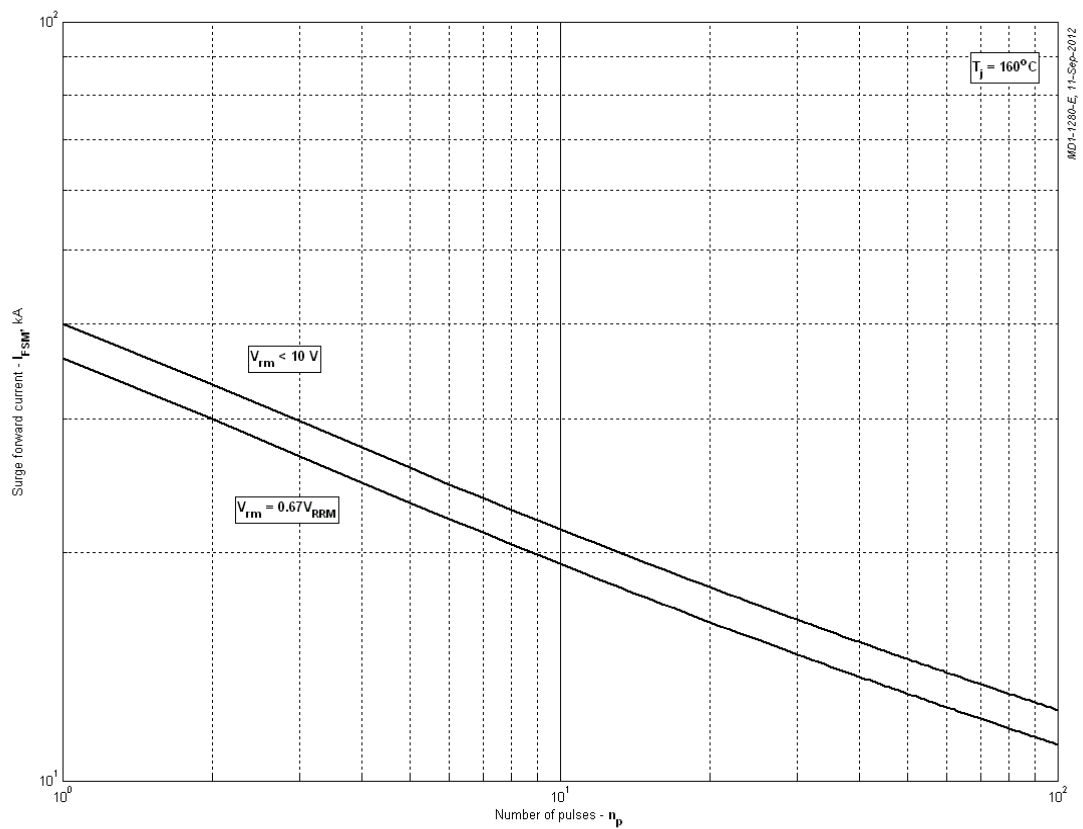

Fig 12 – Maximum surge ratings