

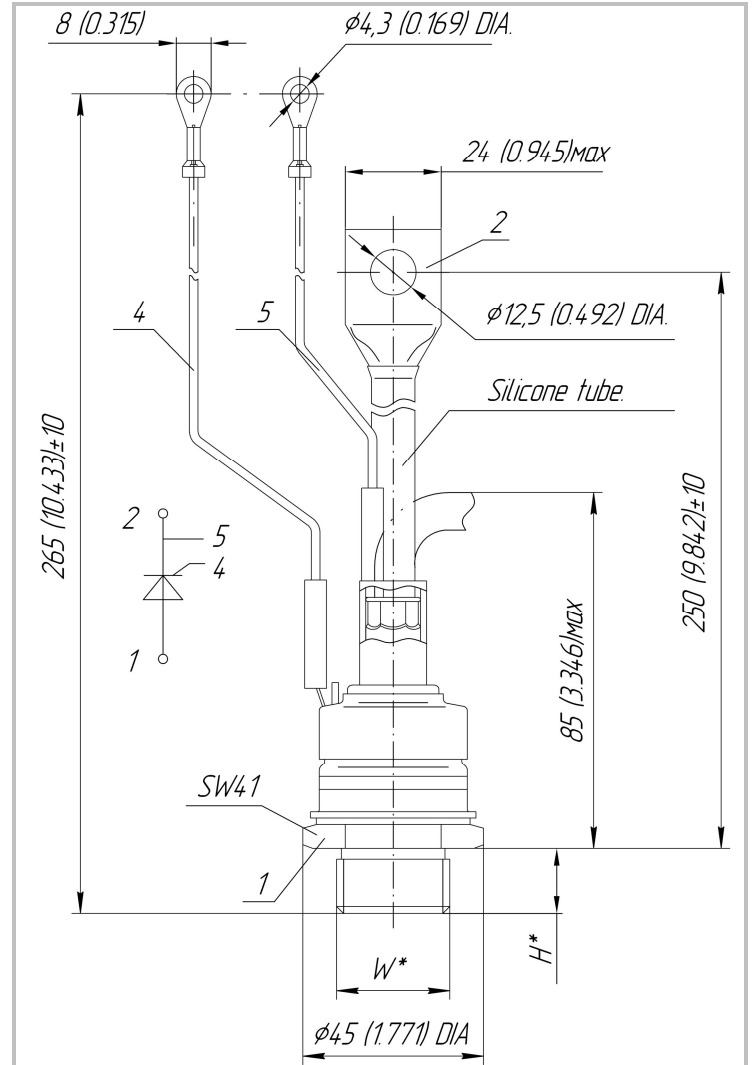

**Package Type T.SB1-xx**

Tightening torque	<b>25 ÷ 35 Nm</b>
Nominal Weight	<b>440 g</b>
<b>D<sub>s</sub></b>	<b>12.4(4.882)</b> Surface creepage distance
<b>D<sub>a</sub></b>	<b>12.4(4.882)</b> Air strike distance



Package type	Type of screw	W	H
T.SB1-MA	Metric Screw-thread	M24x1,5	18 (1,08)
T.SB1-IA	Inch Screw-thread	3/4"-16UNF	27

Polarity for the USA customs

Polarity	Example of code designation	Reference designation	Colors		
			Anode	Cathode	Gate
Anode to stud	T355-SB1-IA-18		-	Black tube	White

Polarity for Europe customs (on default)

Polarity	Example of code designation	Reference designation	Colors		
			Anode	Cathode	Gate
Anode to stud	T355-SB1-MA-18		-	Red tube	White

\*Please inform us about type of color marking (for the USA or Europe)