

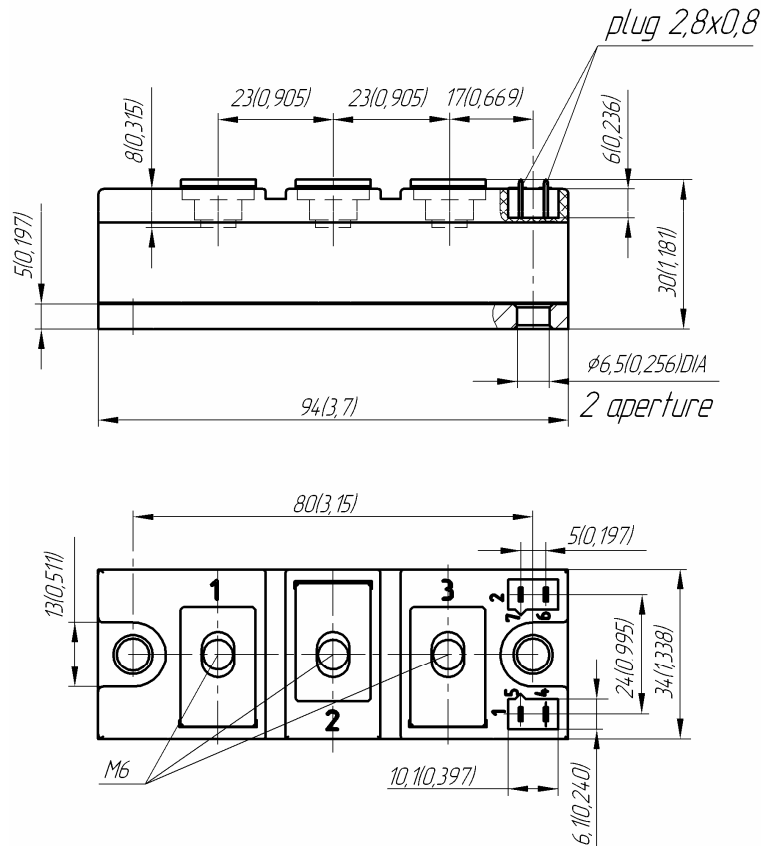

Electrically isolated base plate
Industrial standard package
Simplified mechanical design, rapid assembly
Pressure contact

**Double Diode Module
For Phase Control
MDx-245-18-F**

Average forward current		I_{FAV}		245 A	
Repetitive peak reverse voltage		V_{RRM}		1000 ÷ 1800 V	
V_{RRM} , V	1000	1200	1400	1600	1800
Voltage code	10	12	14	16	18
T_j , °C	- 40 ÷ 150				

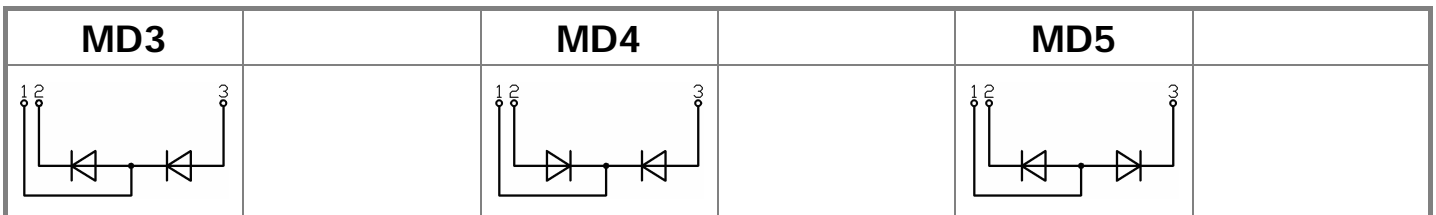

All dimensions in millimeters (inches)

JSC "PROTON-ELECTROTEX"

19 Leskova, 302027, Orel, RUSSIA, Fax : +7 (4862) 41-00-56 Phones : +7 (4862) 43-41-39 / 43-41-40

E-mail: eletex@eletex.ru / eltex@orel.ru; I-net: www.eletex.ru

MAXIMUM ALLOWABLE RATINGS

Symbols and parameters		Units	Values	Test conditions	
ON-STATE					
I_{FAV}	Average forward current	A	245	$T_c = 100\text{ }^\circ\text{C}$; 180° half-sine wave; 50 Hz	
I_{FRMS}	RMS forward current	A	385		
I_{FSM}	Surge forward current	kA	8.1 9.5	$T_j = T_{j\max}$ $T_j = 25\text{ }^\circ\text{C}$	180° half-sine wave; 50 Hz ($t_p = 10\text{ ms}$); single pulse; $V_R = 0\text{ V}$;
			9.0 10.5	$T_j = T_{j\max}$ $T_j = 25\text{ }^\circ\text{C}$	180° half-sine wave; 60 Hz ($t_p = 8.3\text{ ms}$); single pulse; $V_R = 0\text{ V}$;
I^2t	Safety factor	$A^2s \cdot 10^3$	325 430	$T_j = T_{j\max}$ $T_j = 25\text{ }^\circ\text{C}$	180° half-sine wave; 50 Hz ($t_p = 10\text{ ms}$); single pulse; $V_R = 0\text{ V}$;
			335 445	$T_j = T_{j\max}$ $T_j = 25\text{ }^\circ\text{C}$	180° half-sine wave; 60 Hz ($t_p = 8.3\text{ ms}$); single pulse; $V_R = 0\text{ V}$;
BLOCKING					
V_{RRM}	Repetitive peak reverse voltages	V	1000÷1800	$T_{j\min} < T_j < T_{j\max}$; 180° half-sine wave; 50 Hz;	
V_{RSM}	Non-repetitive peak reverse voltages	V	1100÷1900	$T_{j\min} < T_j < T_{j\max}$; 180° half-sine wave; 50 Hz; single pulse;	
V_R	Reverse continuous voltages	V	$0.75 \cdot V_{RRM}$	$T_j = T_{j\max}$;	
THERMAL					
T_{stg}	Storage temperature	$^\circ\text{C}$	- 40 ÷ 125		
T_j	Operating junction temperature	$^\circ\text{C}$	- 40 ÷ 150		
MECHANICAL					
a	Acceleration under vibration	m/s^2	50		

CHARACTERISTICS

Symbols and parameters		Units	Values	Conditions	
ON-STATE					
V_{FM}	Peak forward voltage, max	V	1.30	$T_j = 25\text{ }^\circ\text{C}$; $I_{FM} = 500\text{ A}$	
$V_{F(TO)}$	Forward threshold voltage, max	V	0.75	$T_j = T_{j\max}$; $0.5 \pi I_{FAV} < I_T < 1.5 \pi I_{FAV}$	
r_T	Forward slope resistance, max	$\text{m}\Omega$	0.640		
BLOCKING					
I_{RRM}	Repetitive peak reverse current, max	mA	20	$T_j = T_{j\max}$; $V_R = V_{RRM}$	
SWITCHING					
Q_{rr}	Total recovered charge, max	μC	585	$T_j = T_{j\max}$; $I_{FM} = 200\text{ A}$; $di_R/dt = -10\text{ A}/\mu\text{s}$; $V_R = 100\text{ V}$;	
t_{rr}	Reverse recovery time, max	μs	13		
I_{rrM}	Peak reverse recovery current, max	A	90		
THERMAL					
R_{thjc}	Thermal resistance, junction to case			180° half-sine wave, 50 Hz DC	
	per module	$^\circ\text{C}/\text{W}$	0.0900		
	per arm	$^\circ\text{C}/\text{W}$	0.1800		
	per module	$^\circ\text{C}/\text{W}$	0.0850		
	per arm	$^\circ\text{C}/\text{W}$	0.1700		
R_{thch}	Thermal resistance, case to heatsink				
	per module	$^\circ\text{C}/\text{W}$	0.0300		
	per arm	$^\circ\text{C}/\text{W}$	0.0600		

JSC "PROTON-ELECTROTEX"

19 Leskova, 302027, Orel, RUSSIA, Fax : +7 (4862) 41-00-56 Phones : +7 (4862) 43-41-39 / 43-41-40

E-mail: eletex@eletex.ru / eltex@orel.ru; I-net: www.eletex.ru

INSULATION					
V _{ISOL}	Insulation test voltage	kV	3.00	Sine wave, 50 Hz; RMS	t=1 min
			3.60		t=1 sec
MECHANICAL					
M ₁	Mounting torque (M6) ¹⁾	Nm	6.00	Tolerance ± 15%	
M ₂	Terminal connection torque (M6) ¹⁾	Nm	6.00	Tolerance ± 15%	
w	Weight	g	320		

PART NUMBERING GUIDE						NOTES					
MD	3	-	245	-	18	-	F	-	N		
1	2		3		4		5		6		
1. MD - Rectifier Diode 2. Circuit Schematic 3. Average Forward Current, A 4. Voltage Code 5. Package Type (M.F) 6. Ambient Conditions: N – Normal											¹⁾ The screws must be lubricated

The information contained herein is confidential and protected by Copyright.
 In the interest of product improvement, Proton-Electrotex reserves the right to change data sheet without notice.

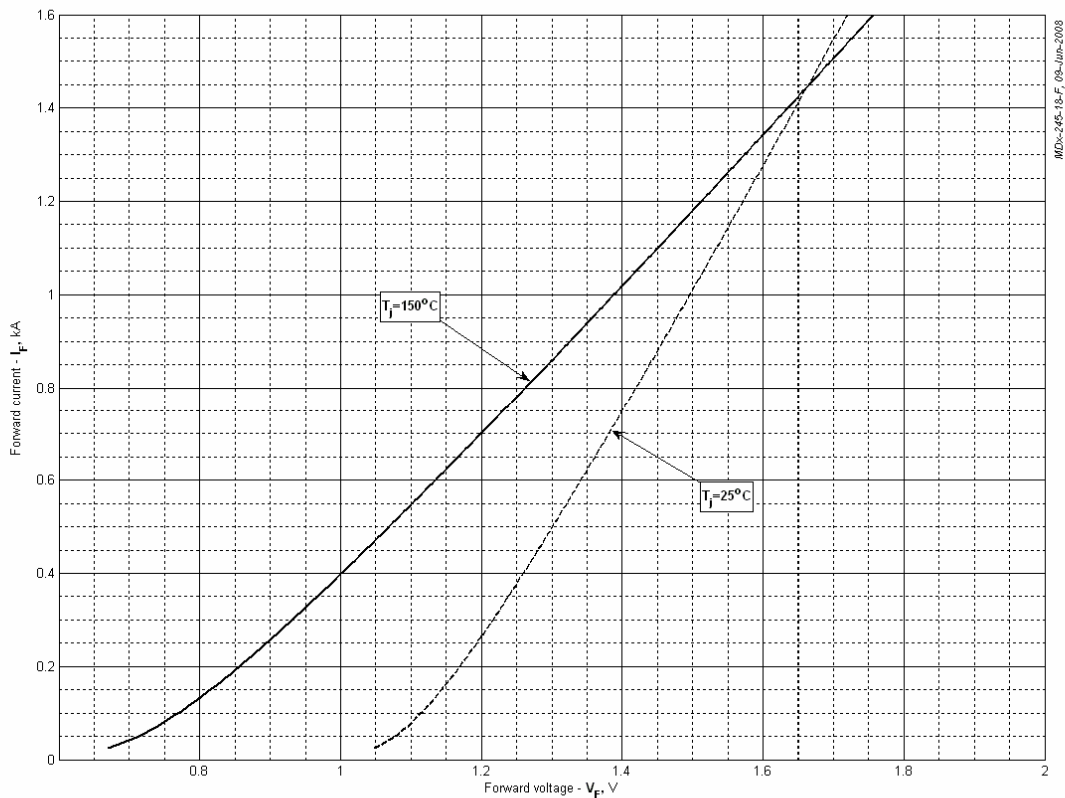

Fig 1 – On-state characteristics of Limit device

Analytical function for On-state characteristic:

$$V_F = A + B \cdot i_F + C \cdot \ln(i_F + 1) + D \cdot \sqrt{i_F}$$

	Coefficients for max curves	
	$T_J = 25^\circ\text{C}$	$T_J = T_{J\text{max}}$
A	0.997281	0.595210
B	0.333859	0.559089
C	-0.245214	-0.348072
D	0.334485	0.474789

On-state characteristic model (see Fig. 1)

JSC "PROTON-ELECTROTEX"

19 Leskova, 302027, Orel, RUSSIA, Fax : +7 (4862) 41-00-56 Phones : +7 (4862) 43-41-39 / 43-41-40

E-mail: eletex@eletex.ru / eltex@orel.ru; I-net: www.eletex.ru

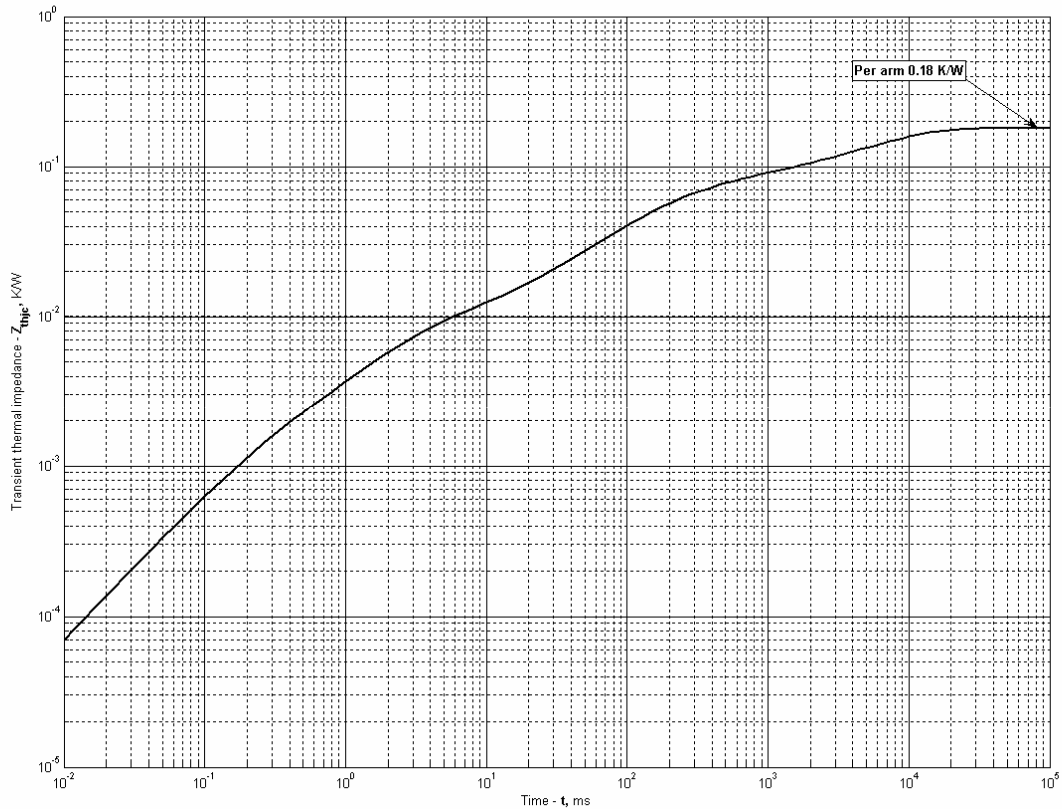

Fig 2 – Transient thermal impedance

Analytical function for Transient thermal impedance junction to case Z_{thjc} for DC:

$$Z_{thjc} = \sum_{i=1}^n R_i \left(1 - e^{-\frac{t}{\tau_i}} \right)$$

Where $i = 1$ to n , n is the number of terms in the series.

t = Duration of heating pulse in seconds.

Z_{thjc} = Thermal resistance at time t .

R_i = Amplitude of p_{th} term.

τ_i = Time constant of r_{th} term.

i	1	2	3	4	5	6
$R_i, K/W$	0.0007653	0.00703	0.01629	0.04126	0.01513	0.09951
τ_i, S	0.0002111	0.002366	0.06905	0.1909	0.6646	6.64

Transient thermal impedance junction to case Z_{thjc} model (see Fig. 2)

JSC "PROTON-ELECTROTEX"

19 Leskova, 302027, Orel, RUSSIA, Fax : +7 (4862) 41-00-56 Phones : +7 (4862) 43-41-39 / 43-41-40

E-mail: eletex@eletex.ru / eltex@orel.ru; I-net: www.eletex.ru

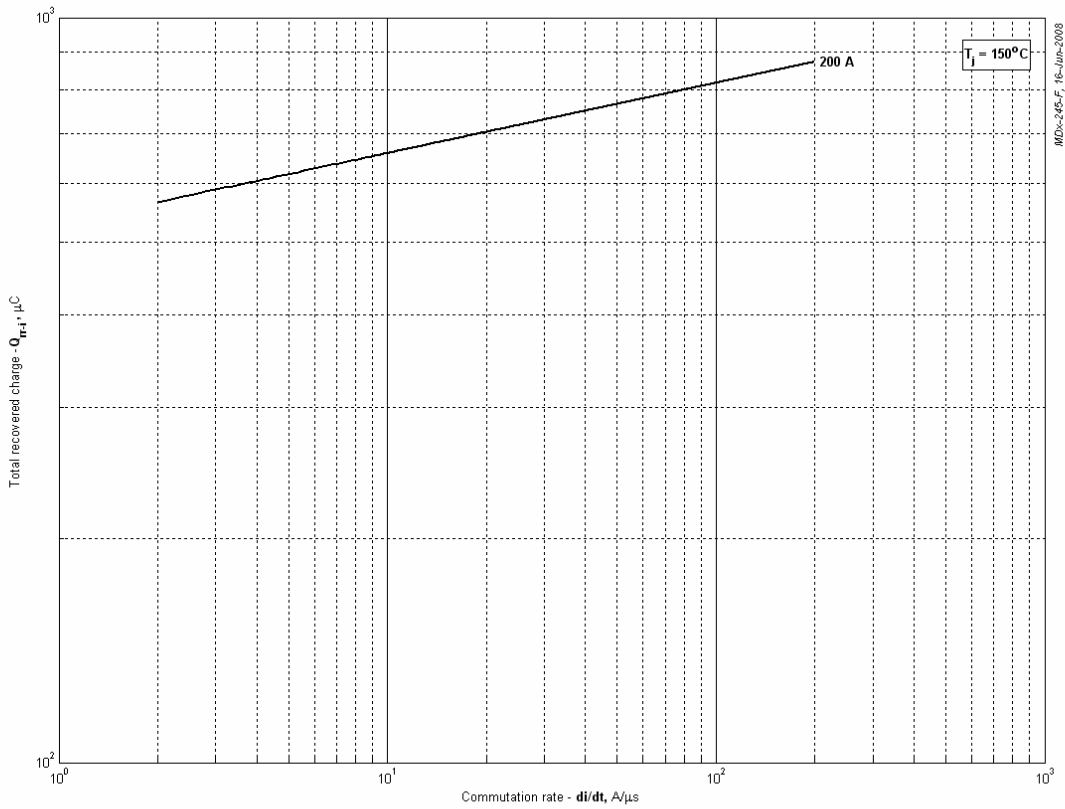

Fig 3 – Total recovered charge, Q_{rr1} (integral)

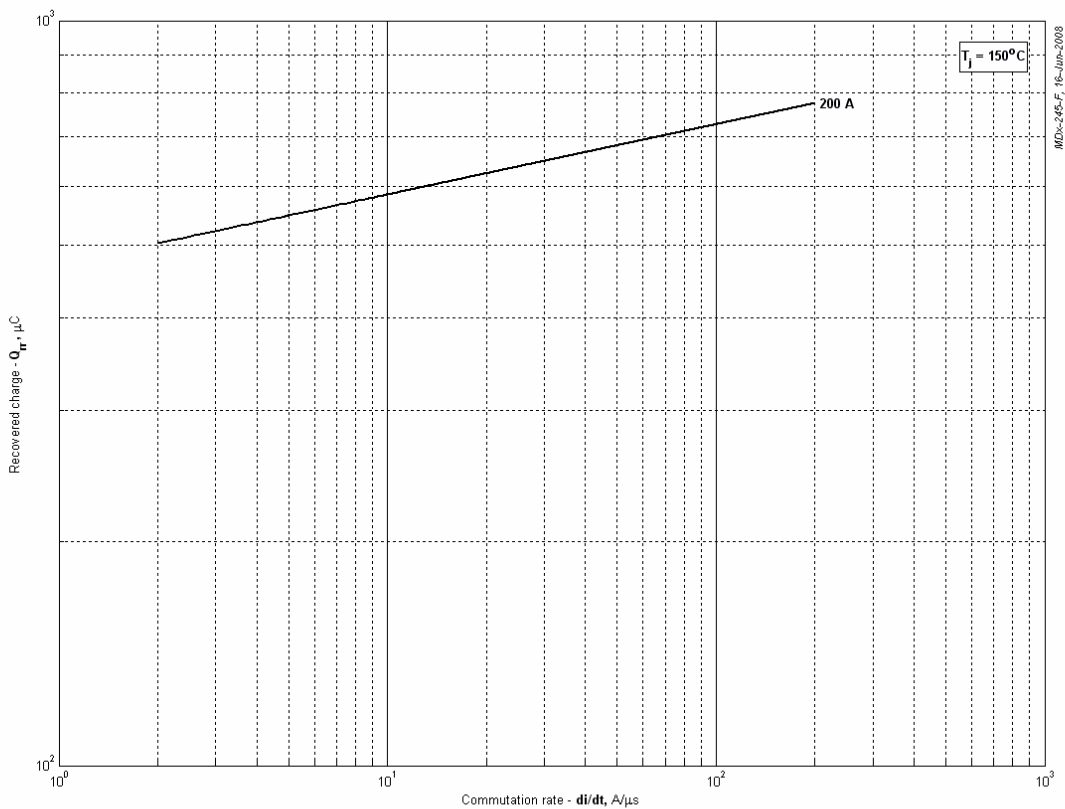

Fig 4 - Recovered charge, Q_{rr} (linear)

JSC "PROTON-ELECTROTEX"

19 Leskova, 302027, Orel, RUSSIA, Fax : +7 (4862) 41-00-56 Phones : +7 (4862) 43-41-39 / 43-41-40

E-mail: eletex@eletex.ru / eltex@orel.ru; I-net: www.eletex.ru

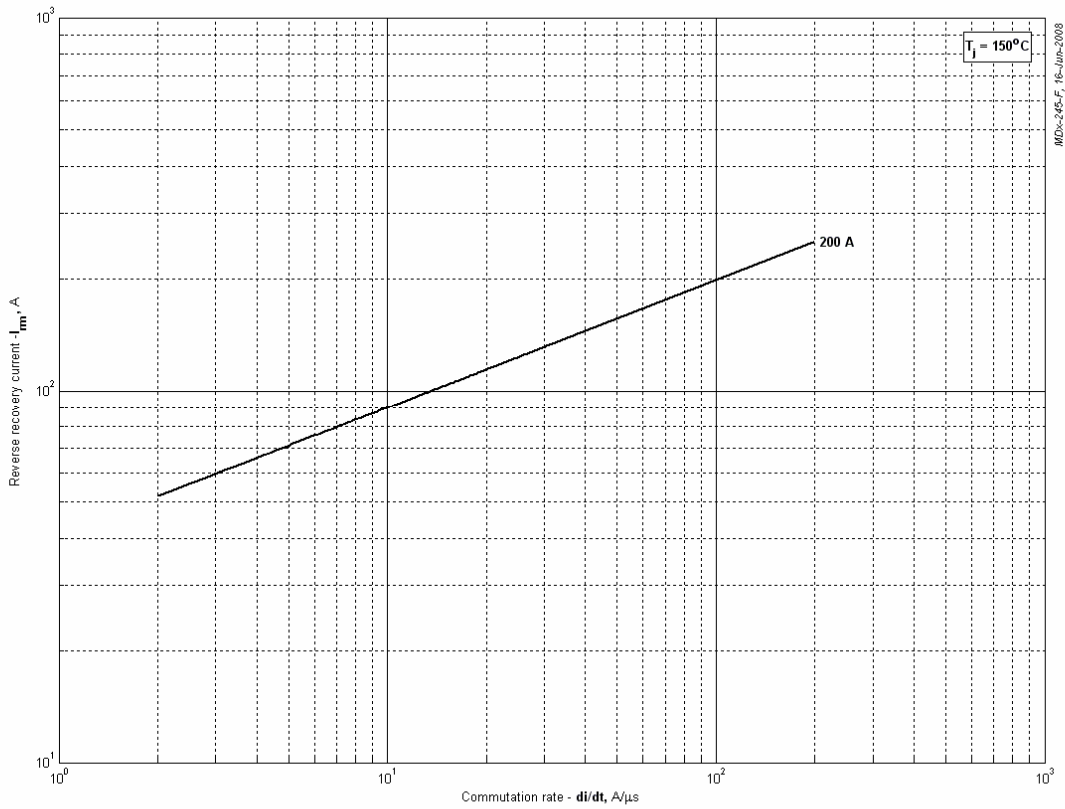

Fig 5 – Peak reverse recovery current, I_{rm}

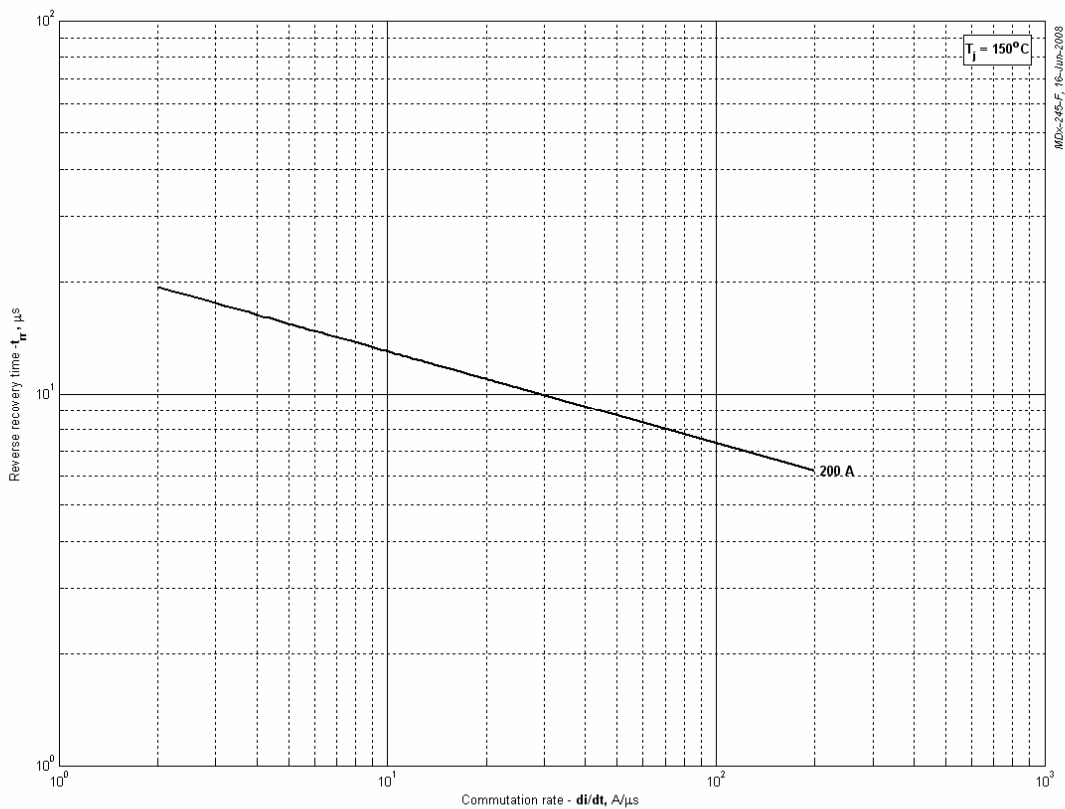

Fig 6 – Maximum recovery time, t_{rr} (linear)

JSC "PROTON-ELECTROTEX"

19 Leskova, 302027, Orel, RUSSIA, Fax : +7 (4862) 41-00-56 Phones : +7 (4862) 43-41-39 / 43-41-40

E-mail: eletex@eletex.ru / eltex@orel.ru; I-net: www.eletex.ru

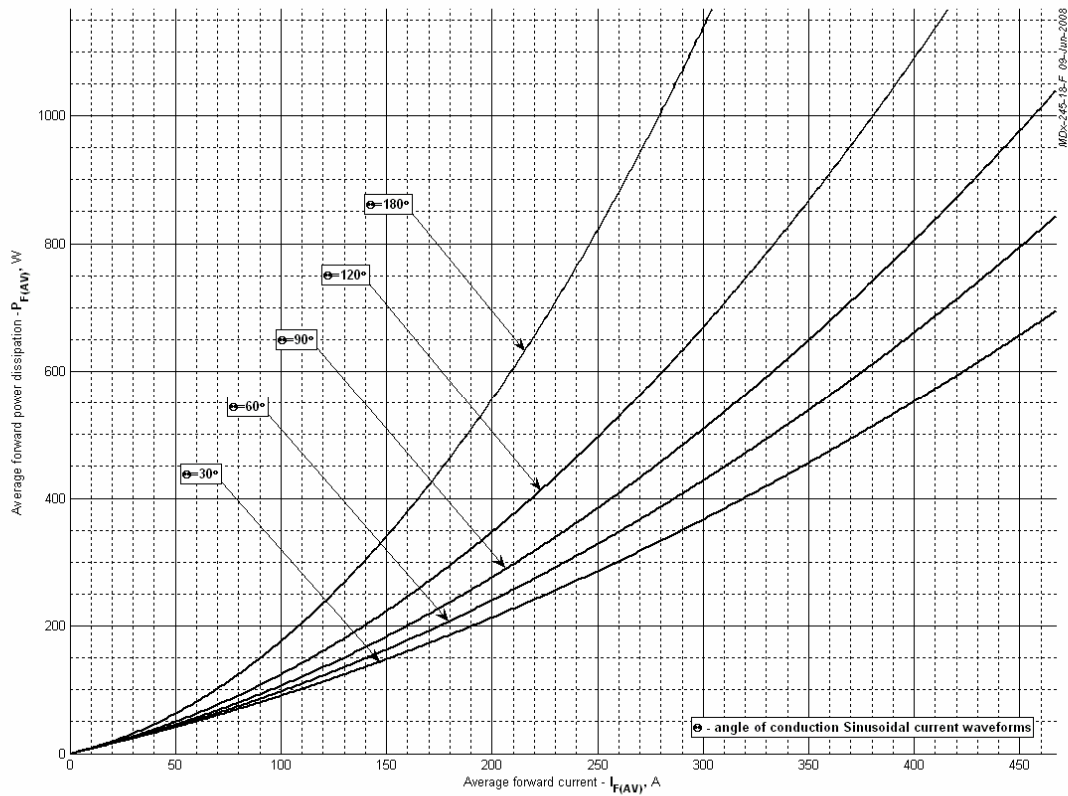

Fig 7 – On-state power loss (sinusoidal current waveforms)

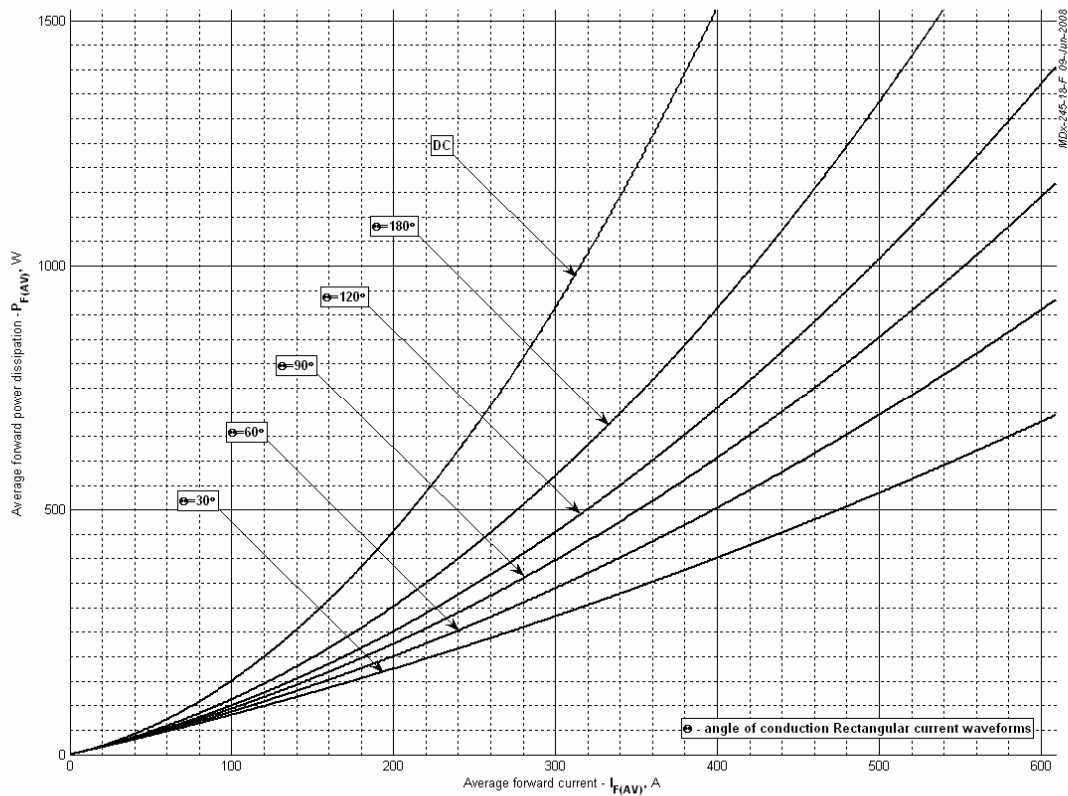

Fig 8 – On-state power loss (rectangular current waveforms)

JSC "PROTON-ELECTROTEX"

19 Leskova, 302027, Orel, RUSSIA, Fax : +7 (4862) 41-00-56 Phones : +7 (4862) 43-41-39 / 43-41-40

E-mail: eletex@eletex.ru / eltex@orel.ru; I-net: www.eletex.ru

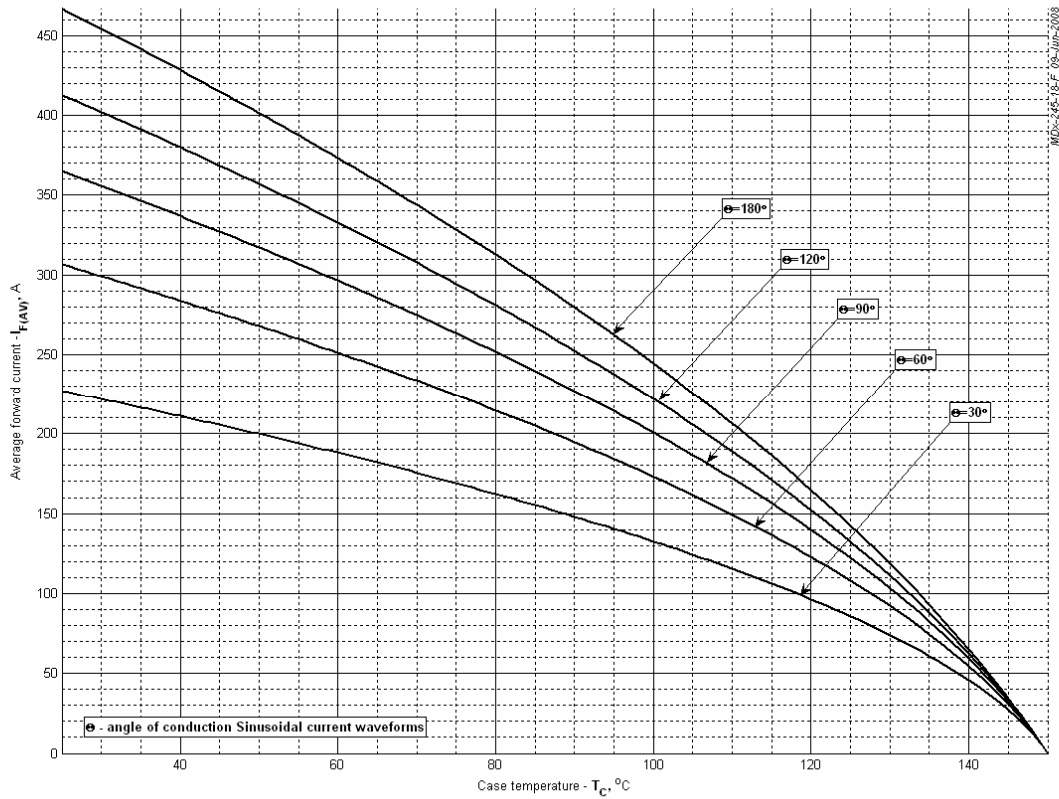

Fig 9 – Maximum case temperature DSC (sinusoidal current waveforms)

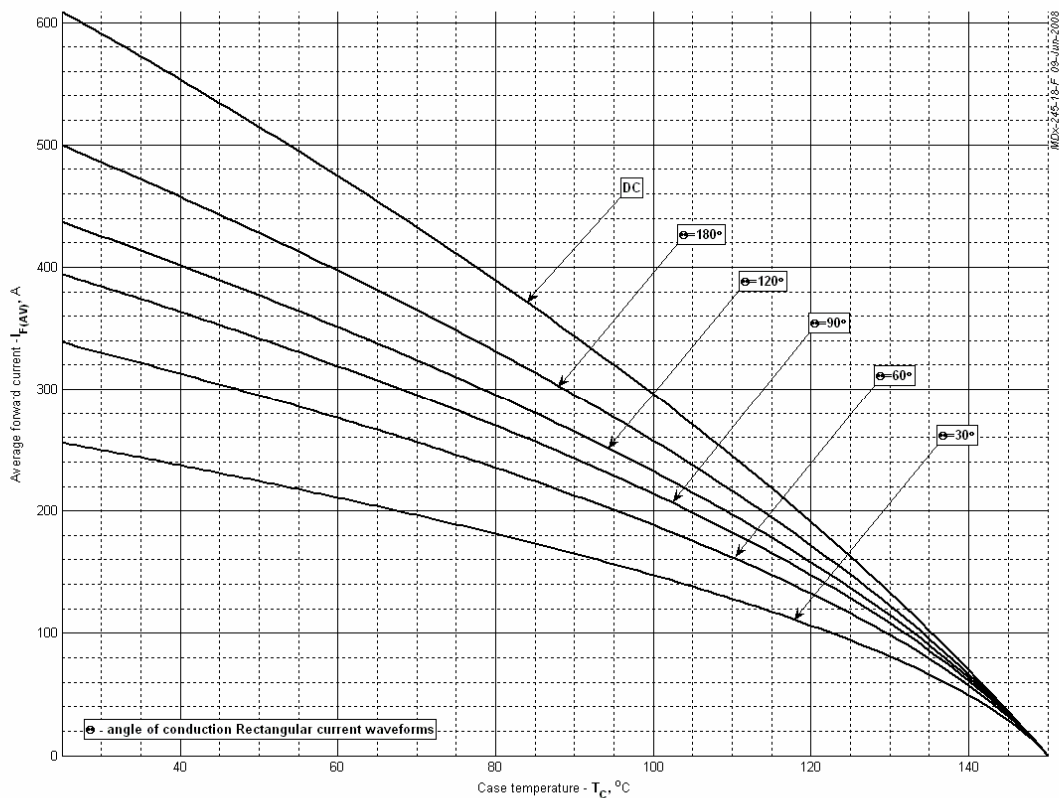

Fig 10 – Maximum case temperature DSC (rectangular current waveforms)

JSC "PROTON-ELECTROTEX"

19 Leskova, 302027, Orel, RUSSIA, Fax : +7 (4862) 41-00-56 Phones : +7 (4862) 43-41-39 / 43-41-40

E-mail: eletex@eletex.ru / eltex@orel.ru; I-net: www.eletex.ru

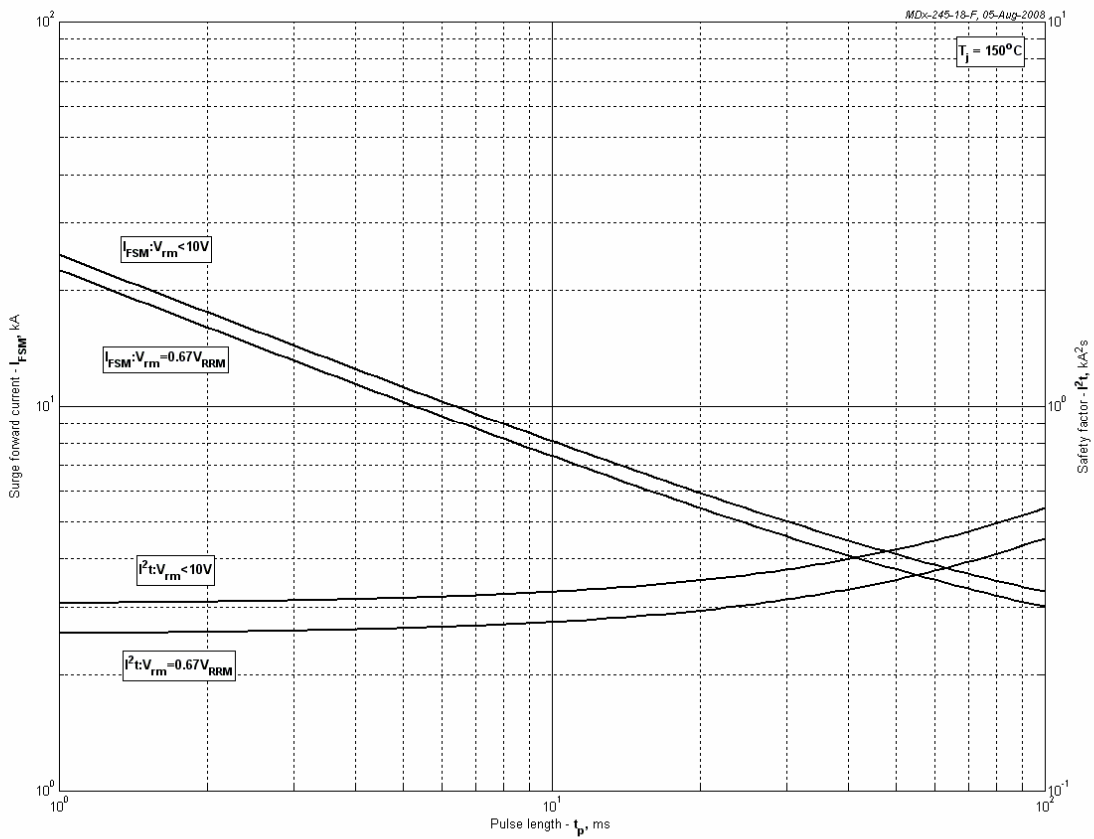

Fig 11 – Maximum surge and I^2t ratings

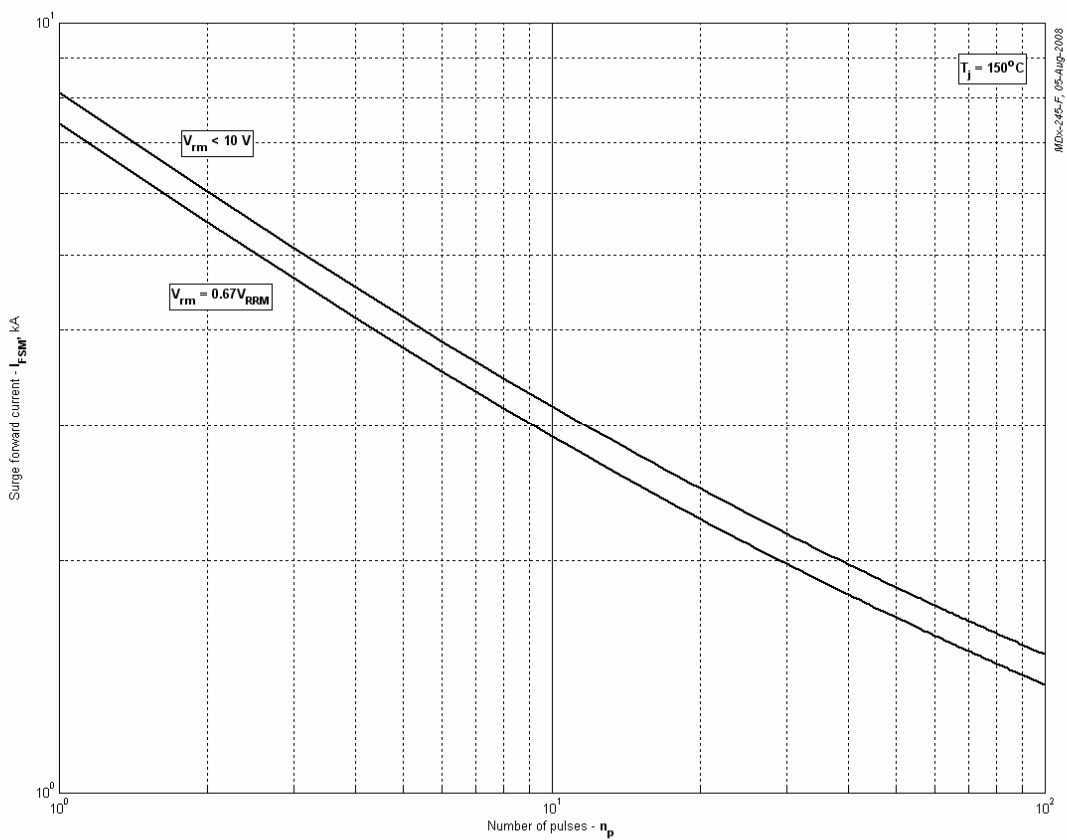

Fig 12 – Maximum surge ratings

JSC "PROTON-ELECTROTEX"

19 Leskova, 302027, Orel, RUSSIA, Fax : +7 (4862) 41-00-56 Phones : +7 (4862) 43-41-39 / 43-41-40

E-mail: eletex@eletex.ru / eltex@orel.ru; I-net: www.eletex.ru