



High power cycling capability
Low on-state and switching losses
Designed for traction and industrial applications

Phase Control Thyristor Type T453-1250-18

Mean on-state current	I_{TAV}	1250 A			
Repetitive peak off-state voltage	V_{DRM}	1000 ÷ 1800 V			
Repetitive peak reverse voltage	V_{RRM}				
Turn-off time	t_q	160 μ s			
V_{DRM}, V_{RRM}, V	1000	1200	1400	1600	1800
Voltage code	10	12	14	16	18
$T_j, ^\circ C$	-60 ÷ 125				

MAXIMUM ALLOWABLE RATINGS

Symbols and parameters		Units	Values	Test conditions
ON-STATE				
I_{TAV}	Mean on-state current	A	1250 1370	$T_c=90^\circ C$, Double side cooled $T_c=85^\circ C$, Double side cooled 180° half-sine wave; 50 Hz
I_{TRMS}	RMS on-state current	A	1962	$T_c=90^\circ C$, Double side cooled 180° half-sine wave; 50 Hz
I_{TSM}	Surge on-state current	kA	24.0 28.0	$T_j=T_{j\ max}$ $T_j=25^\circ C$ 180° half-sine wave; 50 Hz ($t_p=10$ ms); single pulse; $V_D=V_R=0$ V; Gate pulse: $I_G=2$ A; $t_{GP}=50$ μ s; $di_G/dt \geq 1$ A/ μ s
			26.0 30.0	$T_j=T_{j\ max}$ $T_j=25^\circ C$ 180° half-sine wave; 60 Hz ($t_p=8.3$ ms); single pulse; $V_D=V_R=0$ V; Gate pulse: $I_G=2$ A; $t_{GP}=50$ μ s; $di_G/dt \geq 1$ A/ μ s
I^2t	Safety factor	$A^2s \cdot 10^3$	2880 3920	$T_j=T_{j\ max}$ $T_j=25^\circ C$ 180° half-sine wave; 50 Hz ($t_p=10$ ms); single pulse; $V_D=V_R=0$ V; Gate pulse: $I_G=2$ A; $t_{GP}=50$ μ s; $di_G/dt \geq 1$ A/ μ s
			2805 3735	$T_j=T_{j\ max}$ $T_j=25^\circ C$ 180° half-sine wave; 60 Hz ($t_p=8.3$ ms); single pulse; $V_D=V_R=0$ V; Gate pulse: $I_G=2$ A; $t_{GP}=50$ μ s; $di_G/dt \geq 1$ A/ μ s
BLOCKING				
V_{DRM}, V_{RRM}	Repetitive peak off-state and Repetitive peak reverse voltages	V	1000 ÷ 1800	$T_{j\ min} < T_j < T_{j\ max}$; 180° half-sine wave; 50 Hz; Gate open
V_{DSM}, V_{RSM}	Non-repetitive peak off-state and Non-repetitive peak reverse voltages	V	1100 ÷ 1900	$T_{j\ min} < T_j < T_{j\ max}$; 180° half-sine wave; 50 Hz; single pulse; Gate open
V_D, V_R	Direct off-state and Direct reverse voltages	V	$0.75 \cdot V_{DRM}$ $0.75 \cdot V_{RRM}$	$T_j=T_{j\ max}$; Gate open

TRIGGERING				
I_{FGM}	Peak forward gate current	A	8	$T_j = T_{j\ max}$
V_{RGM}	Peak reverse gate voltage	V	5	
P_G	Gate power dissipation	W	4	$T_j = T_{j\ max}$ for DC gate current
SWITCHING				
$(di_T/dt)_{crit}$	Critical rate of rise of on-state current non-repetitive (f=1 Hz)	A/ μ s	1000	$T_j = T_{j\ max}; V_D = 0.67 \cdot V_{DRM}; I_{TM} = 2 I_{TAV};$ Gate pulse: $I_G = 2\ A;$ $t_{GP} = 50\ \mu s; di_G/dt \geq 1\ A/\mu s$
THERMAL				
T_{stg}	Storage temperature	$^{\circ}C$	-60 ÷ 125	
T_j	Operating junction temperature	$^{\circ}C$	-60 ÷ 125	
MECHANICAL				
F	Mounting force	kN	24.0 ÷ 28.0	
a	Acceleration	m/s^2	50 100	Device unclamped Device clamped

CHARACTERISTICS

Symbols and parameters		Units	Values	Conditions	
ON-STATE					
V_{TM}	Peak on-state voltage, max	V	1.80	$T_j = 25\ ^{\circ}C; I_{TM} = 3925\ A$	
$V_{T(TO)}$	On-state threshold voltage, max	V	0.95	$T_j = T_{j\ max};$	
r_T	On-state slope resistance, max	m Ω	0.200	$0.5\ \pi\ I_{TAV} < I_T < 1.5\ \pi\ I_{TAV}$	
I_L	Latching current, max	mA	1500	$T_j = 25\ ^{\circ}C; V_D = 12\ V;$ Gate pulse: $I_G = 2\ A;$ $t_{GP} = 50\ \mu s; di_G/dt \geq 1\ A/\mu s$	
I_H	Holding current, max	mA	300	$T_j = 25\ ^{\circ}C;$ $V_D = 12\ V;$ Gate open	
BLOCKING					
I_{DRM}, I_{RRM}	Repetitive peak off-state and Repetitive peak reverse currents, max	mA	150	$T_j = T_{j\ max};$ $V_D = V_{DRM}; V_R = V_{RRM}$	
$(dv_D/dt)_{crit}$	Critical rate of rise of off-state voltage ¹⁾ , min	V/ μ s	1000	$T_j = T_{j\ max};$ $V_D = 0.67 \cdot V_{DRM};$ Gate open	
TRIGGERING					
V_{GT}	Gate trigger direct voltage, max	V	5.00	$T_j = T_{j\ min}$ $T_j = 25\ ^{\circ}C$ $T_j = T_{j\ max}$	$V_D = 12\ V; I_D = 3\ A;$ Direct gate current
			3.00		
			2.00		
I_{GT}	Gate trigger direct current, max	mA	500	$T_j = T_{j\ min}$ $T_j = 25\ ^{\circ}C$ $T_j = T_{j\ max}$	
			300		
			200		
V_{GD}	Gate non-trigger direct voltage, min	V	0.25	$T_j = T_{j\ max};$ $V_D = 0.67 \cdot V_{DRM};$	
I_{GD}	Gate non-trigger direct current, min	mA	10.00	Direct gate current	
SWITCHING					
t_{gd}	Delay time	μ s	2.00	$T_j = 25\ ^{\circ}C; V_D = 0.4 \cdot V_{DRM}; I_{TM} = I_{TAV};$ Gate pulse: $I_G = 2\ A;$ $t_{GP} = 50\ \mu s; di_G/dt \geq 1\ A/\mu s$	
t_q	Turn-off time ²⁾ , max	μ s	160	$dv_D/dt = 50\ V/\mu s; T_j = T_{j\ max}; I_{TM} = I_{TAV};$ $di_R/dt = -10\ A/\mu s; V_R = 100V;$ $V_D = 0.67 \cdot V_{DRM}$	

THERMAL					
R_{thjc}	Thermal resistance, junction to case, max	°C/W	0.0180	Direct current	Double side cooled
R_{thjc-A}			0.0396		Anode side cooled
R_{thjc-K}			0.0324		Cathode side cooled
R_{thck}	Thermal resistance, case to heatsink, max	°C/W	0.0040	Direct current	
MECHANICAL					
w	Weight, typ	g	510		
D_s	Surface creepage distance	mm (inch)	31.60 (1.244)		
D_a	Air strike distance	mm (inch)	16.50 (0.649)		

PART NUMBERING GUIDE

T	453	1250	18	N
1	2	3	4	5

1. Phase Control Thyristor
2. Design version
3. Mean on-state current, A
4. Voltage code
5. Ambient conditions: N – normal; T – tropical

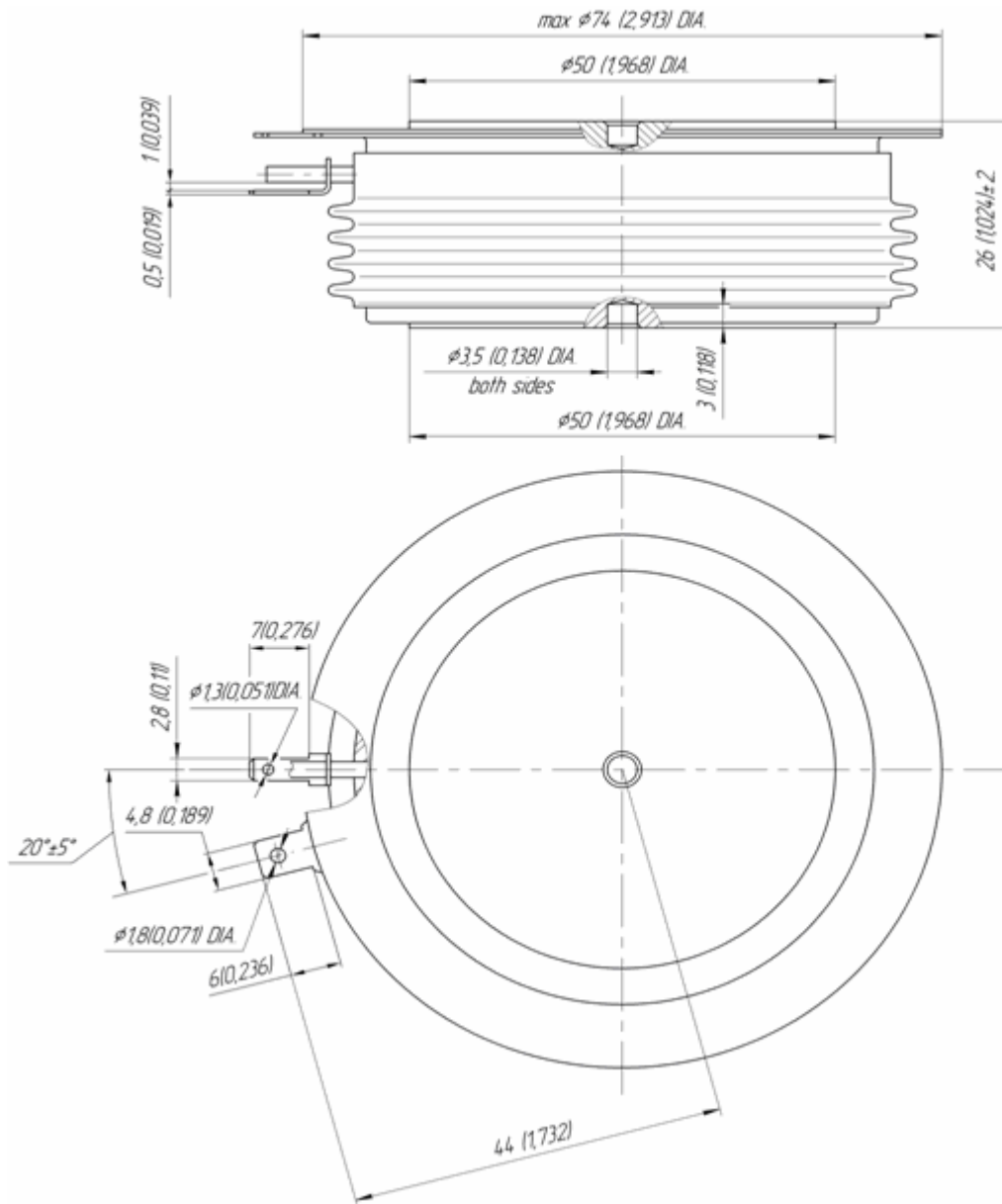

All dimensions in millimeters (inches)